

Assembly and operating instructions

ProMinent® DULCO®flex DF2a

ProMinent®

EN



A1666

**Please carefully read these operating instructions before use. · Do not discard.
The operator shall be liable for any damage caused by installation or operating errors.
The latest version of the operating instructions are available on our homepage.**

General non-discriminatory approach

In order to make it easier to read, this document uses the male form in grammatical structures but with an implied neutral sense. It is aimed equally at both men and women. We kindly ask female readers for their understanding in this simplification of the text.

Supplementary information

➔ Please read the supplementary information in its entirety.

Information







This provides important information relating to the correct operation of the unit or is intended to make your work easier.

Warning information

Warning information includes detailed descriptions of the hazardous situation, see  *Chapter 2.1 „Labelling of Warning Information“ on page 8.*

The following symbols are used to highlight instructions, links, lists, results and other elements in this document:

More symbols

Symbol	Description
	Action, step by step.
	Outcome of an action.
	Links to elements or sections of these instructions or other applicable documents.
	List without set order.

Symbol	Description
<i>[Button]</i>	Display element (e.g. indicators). Operating element (e.g. button, switch).
<i>„Display / GUI“</i>	Screen elements (e.g. buttons, assignment of function keys).
CODE	Presentation of software elements and/or texts.

Table of contents

1	About This Pump	5
2	Safety and Responsibility	8
	2.1 Labelling of Warning Information.....	8
	2.2 Safety notes.....	9
	2.3 Intended use.....	11
	2.4 Users' qualifications.....	12
3	Storage and Transport	14
4	Overview of equipment / Functional description	15
5	Assembly and Installation	16
	5.1 Assembling the peristaltic pump.....	16
	5.2 Installing hose lines.....	18
	5.3 Electrical installation of the peristaltic pump.....	19
6	Start up	22
7	Maintenance, repair and faults	23
	7.1 Maintenance.....	23
	7.2 Repair.....	24
	7.3 Troubleshooting.....	25
8	Decommissioning and Disposal	26
	8.1 Disposal of Used Parts.....	27
9	Technical data	28
	9.1 Accessories and spare parts.....	32
	9.2 Dimension sheet.....	33
10	EU Declaration of Conformity for Machinery	34
11	Index	35

1 About This Pump

The ProMinent® DULCO®flex peristaltic pump is designed for use in swimming pools, hot tubs, and spas and wellness zones.

About This Pump

Identity Code

DF 2a	DULCO®flex, Version DF2a	
	Pump type:	
02 04	1.5 bar; 0.4 litres/h, 5 1/min	
02 08	1.5 bar; 0.8 litres/h, 10 1/min	
02 16	1.5 bar; 1.6 litres/h, 20 1/min	
02 24	1.5 bar; 2.4 litres/h, 30 1/min	
	Hose material:	
P	PharMed®, 4,8 x 8 mm	
V	Viton®, 4,8 x 8,1 mm , for fragrances (custom design)	
	Design:	
0	With ProMinent® logo	
1	Without ProMinent® logo	
P	Pool design	
	Hydraulic connector:	
0	Standard, 6 x 4, suction and discharge side	
9	Special connector, 10 x 4, discharge side	
	Electrical connection:	
A	230 V, 50/60 Hz	
	Cable and plug:	
0	without cable	
1	with cable, 2.0 m, open end	

DF 2a	DULCO®flex, Version DF2a					
					4	with cable, 0.8 m, open end
					A	with cable, 2.0 m, European plug (EN 50075)
						Control:
					0	Mains power supply ON/OFF
						Mounting type:
					W	Wall-mounting
						Accessories:
					0	without accessories
					1	with foot valve 1/4", lipped injection valve, 2 m suction line, 5 m discharge line

2 Safety and Responsibility

2.1 Labelling of Warning Information

Introduction

These operating instructions provide information on the technical data and functions of the product. These operating instructions provide detailed warning information and are provided as clear step-by-step instructions.

The warning information and notes are categorised according to the following scheme. A number of different symbols are used to denote different situations. The symbols shown here serve only as examples.

DANGER!

Nature and source of the danger

Consequence: Fatal or very serious injuries.

Measure to be taken to avoid this danger.

Description of hazard

- Denotes an immediate threatening danger. If the situation is disregarded, it will result in fatal or very serious injuries.

WARNING!

Nature and source of the danger

Possible consequence: Fatal or very serious injuries.

Measure to be taken to avoid this danger.

- Denotes a possibly hazardous situation. If the situation is disregarded, it could result in fatal or very serious injuries.

CAUTION!

Nature and source of the danger

Possible consequence: Slight or minor injuries. Material damage.

Measure to be taken to avoid this danger.

- Denotes a possibly hazardous situation. If the situation is disregarded, it could result in slight or minor injuries. May also be used as a warning about material damage.

! NOTICE!

Nature and source of the danger

Damage to the product or its surroundings.

Measure to be taken to avoid this danger.

- Denotes a possibly damaging situation. If the situation is disregarded, the product or an object in its vicinity could be damaged.



Type of information

Hints on use and additional information.

Source of the information. Additional measures.

- *Denotes hints on use and other useful information. It does not indicate a hazardous or damaging situation.*

2.2 Safety notes



WARNING!

Danger from hazardous substances!

Possible consequence: Fatal or very serious injuries.

Please ensure when handling hazardous substances that you have read the latest safety data sheets provided by the manufacturer of the hazardous substance. The actions required are described in the safety data sheet. Check the safety data sheet regularly and replace, if necessary, as the hazard potential of a substance can be re-evaluated at any time based on new findings.

The system operator is responsible for ensuring that these safety data sheets are available and that they are kept up to date, as well as for producing an associated hazard assessment for the workstations affected.

 **WARNING!**

Danger of electric shock

Mains voltage may be present inside the pump housing.

Immediately disconnect the pump from the mains power supply if the pump housing has been damaged. Only return the pump to service after an authorised repair.

 **CAUTION!**

Personnel injury and material damage

The pump can start to pump, as soon as it is connected to mains voltage.

Install an emergency cut-off switch in the pump power supply line or integrate the pump in the emergency cut-off management of the system.

 **CAUTION!**

Warning of feed chemical spraying around

The metering pump can generate a multiple of its rated pressure. Hydraulic parts may burst if a discharge line is blocked. -

Correctly install a relief valve in the discharge line downstream of the metering pump.

 **CAUTION!**

Device starts immediately

The unit does not have an On/Of switch and begins to work as soon as it is connected to the mains voltage.

Only connect the device to the mains voltage when all installation work has been completed and the pumped chemicals can no longer escape in an uncontrolled manner.

 **CAUTION!**

Warning of backflow

Metering pumps are not absolutely leak-tight shut-off devices.

Use a shut-off valve, a solenoid valve or a vacuum breaker for this purpose.

 **CAUTION!**

Contact with chemicals

De-pressurise, drain and rinse the hydraulic part of the unit before working on it.

**Protective equipment**

The transparent cover on the liquid end serves to prevent direct contact with the rotor and escaping chemicals in the event of a ruptured hose.

Information in the event of an emergency

In the event of an electrical accident, disconnect the mains cable from the mains power supply or press the emergency cut-off switch fitted on the side of the system. If feed chemical is escaping, switch off the pump by pressing *[Stop/Start]*. If necessary ensure that the hydraulic system around the pump is at atmospheric pressure. Adhere to the safety data sheet for the feed chemical.

2.3 Intended use

- Only use the unit to meter liquid media.
- Only use the unit in accordance with the technical data and specifications outlined in the operating instructions.
- Any other uses or modifications to the system are prohibited
- Do not use the unit to meter gaseous media or solids.
- Do not use the unit to meter flammable media.

- Only use the unit with further protection (exterior housing, weather-proof roof) for external use. The housing can be affected by direct sunlight
- Only allow adequately qualified and technically expert personnel to operate the unit
- Observe the general limitations with regard to viscosity limits, chemical resistance and density - refer also to the ProMinent® Resistance List in the Product Catalogue or at www.prominent.com!
- The pump is not intended for operation in areas at risk from explosion.

All other uses or modifications are prohibited.

2.4 Users' qualifications

WARNING!

Danger of injury with inadequately qualified personnel!

The operator of the plant / device is responsible for ensuring that the qualifications are fulfilled.

If inadequately qualified personnel work on the unit or loiter in the hazard zone of the unit, this could result in dangers that could cause serious injuries and material damage.

- All work on the unit should therefore only be conducted by qualified personnel.
- Unqualified personnel should be kept away from the hazard zone

Training	Definition
Instructed personnel	An instructed person is deemed to be a person who has been instructed and, if required, trained in the tasks assigned to him/her and possible dangers that could result from improper behaviour, as well as having been instructed in the required protective equipment and protective measures.
Trained user	A trained user is a person who fulfils the requirements made of an instructed person and who has also received additional training specific to the system from ProMinent or another authorised distribution partner.
Trained qualified personnel	A qualified employee is deemed to be a person who is able to assess the tasks assigned to him and recognize possible hazards based on his/her training, knowledge and experience, as well as knowledge of pertinent regulations. The assessment of a person's technical training can also be based on several years of work in the relevant field.

Training	Definition
Electrician	<p>Electricians are deemed to be people, who are able to complete work on electrical systems and recognize and avoid possible hazards independently based on his/her technical training and experience, as well as knowledge of pertinent standards and regulations.</p> <p>Electricians should be specifically trained for the working environment in which they are employed and know the relevant standards and regulations.</p> <p>Electricians must comply with the provisions of the applicable statutory directives on accident prevention.</p>
Customer Service department	Customer Service department refers to service technicians, who have received proven training and have been authorised by ProMinent to work on the system.



Note for the system operator

The pertinent accident prevention regulations, as well as all other generally acknowledged safety regulations, must be adhered to!

3 Storage and Transport

Store and transport the unit in its original packaging.

Protect the unit against moisture and the effects of chemicals, even while still packaged.

Ambient conditions for storage and transport

Permissible ambient temperature:
-10 ... 45 °C

Permissible storage temperature:
-10 ... 55 °C

Permissible medium temperature:
-10 ... 45 °C

Humidity: max. 95 % rel. humidity,
condensation not permitted.

Other: No direct sunlight.

4 Overview of equipment / Functional description

Overview of equipment

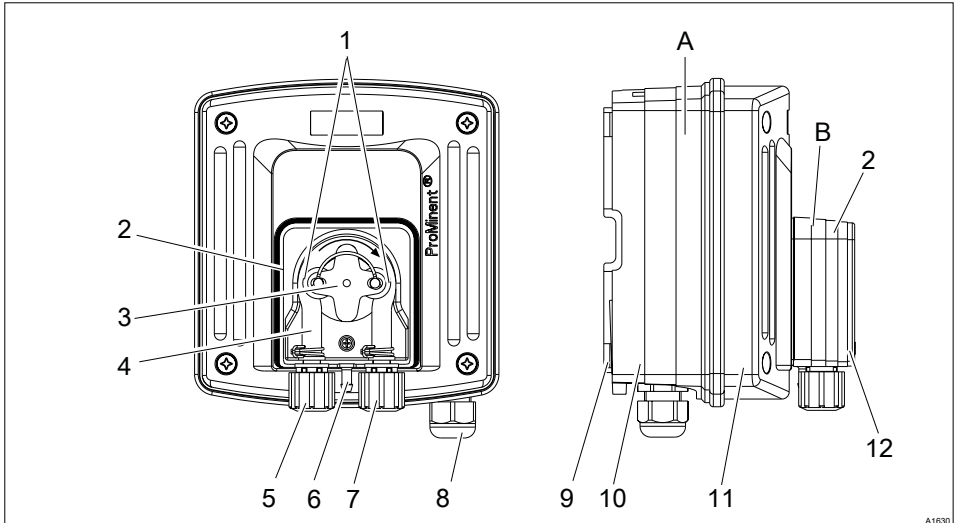

A1630

Fig. 1: Overview of equipment

- | | |
|------------------------------------|---|
| 1. Rollers with tensioning springs | 9. Wall bracket |
| 2. Dosing head | 10. Rear section of housing, power end |
| 3. Rotor | 11. Upper section of housing, power end |
| 4. Pump hose | 12. Transparent cover |
| 5. Hose connector, suction side | A. Drive unit |
| 6. Leakage fitting | B. Liquid end |
| 7. Hose connector, discharge side | |
| 8. Threaded connector | |

Functional description

An electric motor drives a rotor. Spring-mounted rollers are fitted to the ends of the rotors, which press the pump hose against the inner wall of the dosing head.

The peristaltic pump operates by the rollers driving the feed chemical through the pump hose. The feed chemical is primed by the pump hose returning to its initial position.

5 Assembly and Installation

- **User qualification, mechanical installation:** trained qualified personnel, see ↪ *Chapter 2.4 „Users' qualifications“ on page 12*
- **User qualification, electrical installation:** Electrical technician, see ↪ *Chapter 2.4 „Users' qualifications“ on page 12*



General information on installation and assembly

The device is resistant to normal atmospheres in plant rooms.

Permissible ambient temperature: -10 ... 45 °C.

Permissible medium temperature: -10 ... 45 °C.

Other ambient conditions: No direct sunlight.

Please observe the applicable national regulations and guidelines during installation.

5.1 Assembling the peristaltic pump

Wall mounting

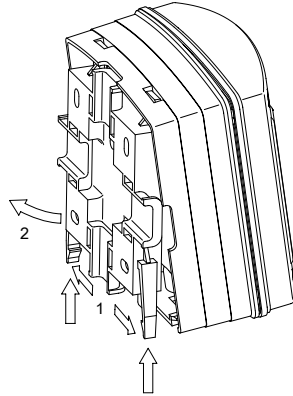
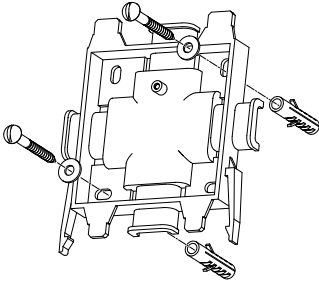

Fig. 2: Removing the wall/tube retaining bracket

- Remove the wall/tube retaining bracket. Pull the two snap-hooks (1) outwards and push upwards
- Fold out the wall/tube retaining bracket (2) and pull out in a downwards direction
- Mark two drill holes diagonally to each other, using the wall/tube retaining bracket as a drilling template
- Drill holes: $\varnothing 8 \text{ mm}$, $d = 50 \text{ mm}$



A0274

Fig. 3: Screw the wall/tube retaining bracket in place using the washers

5. ➤ Screw the wall/tube retaining bracket in place using the washers
6. ➤ Suspend the peristaltic pump at the top of the wall/tube retaining bracket and, using light pressure, press it against the wall/tube retaining bracket at the bottom. Then press upwards until the peristaltic pump audibly snaps into position.

Pipe assembly



Pipe diameter

Pipe diameter: 25 mm to 60 mm.

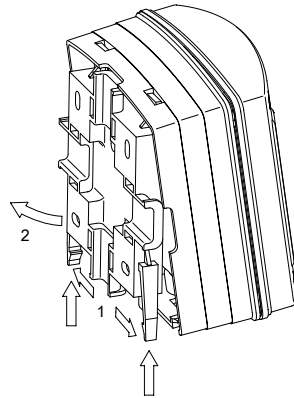

A0273

Fig. 4: Removing the wall/tube retaining bracket

1. ➤ Remove the wall/tube retaining bracket. Pull the two snap-hooks (1) outwards and push upwards
2. ➤ Fold out the wall/tube retaining bracket (2) and pull out in a downwards direction
3. ➤ Secure the wall/tube retaining bracket to the pipe with cable ties (or pipe clamps).

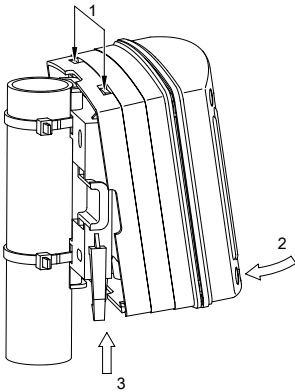

Fig. 5: Suspend the peristaltic pump and fix in place

4. Suspend the peristaltic pump (1) at the top of the wall/tube retaining bracket and, using light pressure, press it against the wall/tube retaining bracket at the bottom (2). Then press upwards (3) until the peristaltic pump audibly snaps into position.

5.2 Installing hose lines



Only use original hoses with the specified hose dimensions 6 x 4 mm or 10 x 4 mm, otherwise the durability of the connection cannot be guaranteed.

Avoid reducing the hose sizes.

The hose lines used must be able to withstand twice the operating pressure of the peristaltic pump.

Assembling the suction and discharge lines.

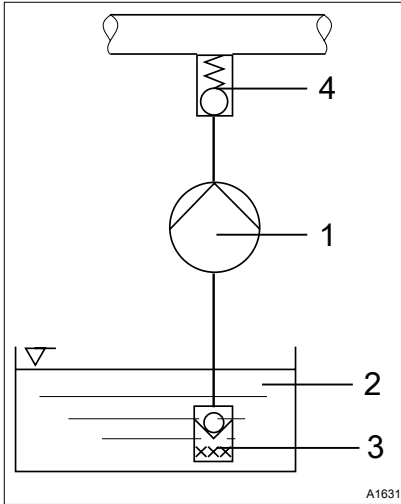

Fig. 6: Installation diagram

1. Peristaltic pump
 2. Chemical tank
 3. Foot valve or suction lance
 4. Injection valve
1. ➤ Cut the end of the hose at right angles.
 2. ➤ Unscrew a union nut and slide the union nut over the pump hose.
 3. ➤ Push the tube end over the nozzle until it will go no further.
 4. ➤ Connect the discharge line to the right hose connector.
 5. ➤ Connect the suction line to the left hose connector.
 6. ➤ Tighten the union nuts.

7. ➤ Shorten the free end of the suction line so that the foot valve hangs just above the base of the tank. With feed chemicals that can form sediment, ensure that the foot valve is suspended a minimum of 50 mm above the base of the tank.
8. ➤ Guide a hose line into the storage tank from the leakage fitting.

5.3 Electrical installation of the peristaltic pump



- *Only carry out the electrical installation once the mechanical and hydraulic installations have been completed.*
- *During installation, ensure that the mains cable is de-energised and has been secured to prevent it from being switched on again.*
- *Fit a short-circuit fuse during installation.*
- *Fit an Off switch for the mains power supply during installation.*

i Mains cable

Let the mains cable project from the housing so that the front section of the housing can be removed.

Remove around 120 mm from the outer insulation of the mains cable.

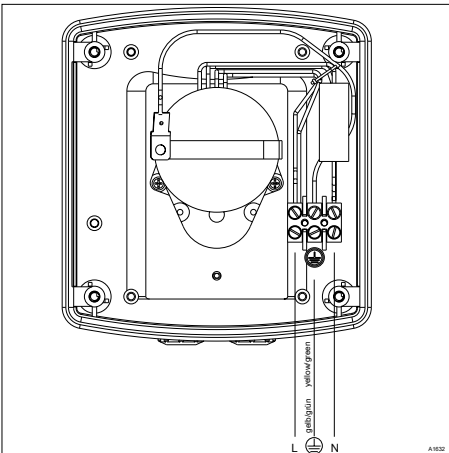

Fig. 7: Terminal diagram

- 1.** ➤ Loosen the four screws and remove the upper part of the housing
- 2.** ➤ Break out the small bore hole at the far right on the underside of the housing
- 3.** ➤ Screw the required threaded connector in and tighten it properly (not the clamping screw)
- 4.** ➤ Insert the reducing insert into the threaded connector depending on the cable cross-section used
- 5.** ➤ Guide the mains cable into the threaded connector
- 6.** ➤ Insulate the mains cable and press on the corresponding cable end sleeves
- 7.** ➤ Connect the mains cable accordingly, see Fig. 7 (protective conductor connection)
- 8.** ➤ Tighten the clamping nut of the threaded connector so that they are properly sealed
- 9.** ➤ Place the front section of the housing on the read section of the housing
- 10.** ➤



Once again check that the seal is seated properly. Protection class IP 65 is only achieved if it is correctly assembled.

Manually tighten the four housing screws

6 Start up

- **User qualification:** trained user, see  Chapter 2.4 „Users' qualifications“ on page 12

WARNING!

Danger from hazardous substances!

Possible consequence: Fatal or very serious injuries.







Please ensure when handling hazardous substances that you have read the latest safety data sheets provided by the manufacturer of the hazardous substance. The actions required are described in the safety data sheet. Check the safety data sheet regularly and replace, if necessary, as the hazard potential of a substance can be re-evaluated at any time based on new findings.

The system operator is responsible for ensuring that these safety data sheets are available and that they are kept up to date, as well as for producing an associated hazard assessment for the workstations affected.



Only operate the pump after proper installation.

Only operate the pump once the transparent cover has been screwed on.

1.  Disconnect the discharge hose from the hose connector.
2.  Allow the peristaltic pump to run until the pump hose is filled.
3.  Switch off the peristaltic pump after the pump hose has been filled
4.  Re-connect the discharge hose to the hose connector.
5.  Allow the peristaltic pump to run for a short time
 - ⇒ The peristaltic pump is now ready for operation.
6.  Check the threaded connectors and pipe system for leak-tightness

7 Maintenance, repair and faults

- **User qualification:** trained user, see  Chapter 2.4 „Users' qualifications“ on page 12



WARNING!

Danger from hazardous substances!

Possible consequence: Fatal or very serious injuries.

Please ensure when handling hazardous substances that you have read the latest safety data sheets provided by the manufacturer of the hazardous substance. The actions required are described in the safety data sheet. Check the safety data sheet regularly and replace, if necessary, as the hazard potential of a substance can be re-evaluated at any time based on new findings.

The system operator is responsible for ensuring that these safety data sheets are available and that they are kept up to date, as well as for producing an associated hazard assessment for the workstations affected.

7.1 Maintenance

After extended periods of idleness

If the peristaltic pump has not pumped gaseous or adhesive feed chemicals for a longer period of time, checked whether the state of the hoses permits reliable operation.

Approx. every six months

Checks:

- Visual control of the liquid end
- Check the pump hose for leak-tightness
- Check the pump connectors for leak-tightness

Shorter maintenance intervals may be necessary depending on the feed chemicals used and operating conditions.

Approx. annually

Replace the pump hose.



This can lead to a reduction in pump capacity over time depending on the operating conditions. Therefore replace the pump hose earlier if necessary.

The power end is maintenance-free.

7.2 Repair



Ensure that the system is at atmospheric pressure.

Drain the pump hose and thoroughly rinse it with a suitable medium.

Only turn the rotor in a clockwise direction.

6. ➤ Briefly switch on the motor. The pump hose moves into the correct position under the rollers
7. ➤ Replace the transparent cover on the housing and screw it into place
8. ➤ Fix the suction hose and the discharge hose to the hose connectors

Changing the pump hose

1. ➤ Loosen the suction hose and the discharge hose from the hose connectors
2. ➤ Loosen the fixing bolt on the transparent cover and remove the transparent cover
3. ➤ Remove the suction-side hose connector (left) from its mounting
4. ➤ Carefully pull the pump hose out under the rollers

5. ➤



When doing so, ensure that the rounded sides of the hose connectors are pointing towards the unit.

Insert the two hose connectors of the new pump hose into the two mountings.

7.3 Troubleshooting

Fault	Cause	Remedy
The peristaltic pump no longer reaches full pump capacity	The pump hose has lost its elasticity	Replace the pump hose, see ↗ <i>Chapter 7.2 „Repair“ on page 24</i>
In all other cases, notify your service technician or your ProMinent branch.		

8 Decommissioning and Disposal

- **User qualification:** instructed user, see  Chapter 2.4 „Users' qualifications“ on page 12

WARNING!

Danger from hazardous substances!

Possible consequence: Fatal or very serious injuries.



Please ensure when handling hazardous substances that you have read the latest safety data sheets provided by the manufacturer of the hazardous substance. The actions required are described in the safety data sheet. Check the safety data sheet regularly and replace, if necessary, as the hazard potential of a substance can be re-evaluated at any time based on new findings.

The system operator is responsible for ensuring that these safety data sheets are available and that they are kept up to date, as well as for producing an associated hazard assessment for the workstations affected.



During decommissioning, de-energise the mains cable and ensure that it cannot be switched on again.

Thoroughly clean the housing and especially the pump hose of chemicals and dirt when decommissioning the unit.

1.  Disconnect the device from the mains power supply
2.  Drain the pump hose and thoroughly rinse it with a suitable medium

Comply with the storage conditions for temporary decommissioning.

8.1 Disposal of Used Parts

- **User qualification:** instructed user, see ↗ *Chapter 2.4 „Users' qualifications“ on page 12*

! NOTICE!

Regulations governing the disposal of used parts

- Note the national regulations and legal standards that currently apply in your country

The manufacturer will take back decontaminated used units providing they are covered by adequate postage.

Decontaminate the unit before returning it for repair. To do so, remove all traces of hazardous substances. Refer to the Material Safety Data Sheet for your feed chemical.

A current Declaration of Decontamination is available to download on the ProMinent website.

9 Technical data

Pump type	Max. pump capacity at max. back pressure			Connector size $\emptyset \times \emptyset$	Suction lift	Priming lift	Permissible priming pressure suction side
	bar	50 Hz	60 Hz	mm	m	m	bar
		l/h	l/h				
0204	1.5	0.4	0.48	6 x 4, 10 x 4	4	2	0.5
0208	1.5	0.8	0.96	6 x 4, 10 x 4	4	2	0.5
0216	1.5	1.6	1.92	6 x 4, 10 x 4	4	2	0.5
0224	1.5	2.4	2.88	6 x 4, 10 x 4	4	2	0.5

All data calculated with water at 20°C.

Precision

The starting precision of the pump capacity is $\pm 10\%$. The pump capacity can fall during operation due to damage to the elasticity of the pump hose.

Materials specifications and resistance

Part	Material
Pump hose	PharMed®
Hose connectors	PVDF
Dosing head	PPE
Transparent cover	PC
Housing (power end)	PPE-GF
Wall bracket	PPE-GF
Housing seal	Silicone
Housing screws	M4 A2
Cable threaded connectors	Polyamide/Neoprene®

Design for fragrance metering

Part	Material
Pump hose	Viton®
Hose connectors	PVDF
Dosing head	PA12
Transparent cover	PA12
Housing (power end)	PP+GF
Wall bracket	PA+GF
Housing seal	Silicone
Housing screws	M4 A2
Cable threaded connectors	Polyamide/Neoprene®

Chemical resistance

The device is resistant to normal atmospheres in plant rooms.

Resistance to chemicals, see ProMinent Resistance List (homepage or Product Catalogue).

UV resistance

- Do not expose the device to direct UV radiation.



No short-circuit fuse is fitted and needs to be taken into consideration in installation.

Description	Data
Dimensions	126 x 136 x 105 mm (WxHxD)
Weight:	Total weight (including installation material) approx. 750 g
	Total weight (net), approx. 600 g
Electrical data:	
Connection voltage:	230 V \pm 10% at 50/60 Hz
Power consumption:	approx. 5 W / DF2a 0224 V approx. 7 w
Switching-on duration:	100% / DF2a 0224 V: 60%
Degree of protection:	Protection class 1, mains connection with protective conductor
Protection against contact and humidity:	IP 65
Permissible ambient temperature: -10 ... 45°C	
Permissible storage temperature: -10 ... 55°C	
Permissible medium temperature: -10 ... 45°C	
Sound pressure level (LpA):	< 30 dB (EN ISO 20361)

9.1 Accessories and spare parts

Accessories

Description	Order number
Installation material for DULCO®flex, complete	1007297
Mains cable	via identity code
Injection valve and foot valve	via identity code
Suction lances	see Product Catalogue

Spare parts

Description	Order number
Hose, Pharmed®	1009480
Hose, Viton®	1023842
Union nut Ø6-G1/4"	1009968
Union nut Ø10-G1/4"	1008908
Adapter G1/4"-M20x1.5, PVC	1044908
Connector set, simple, 10x4 PCB	1002589
Dosing head, PPE	1007672
Transparent cover, PC	1007736
Dosing head, PA	1023844
Transparent cover, PA	1023845
PT bolt Torx, 30x14/6	1008912
Grooved ball bearing	1017985

9.2 Dimension sheet

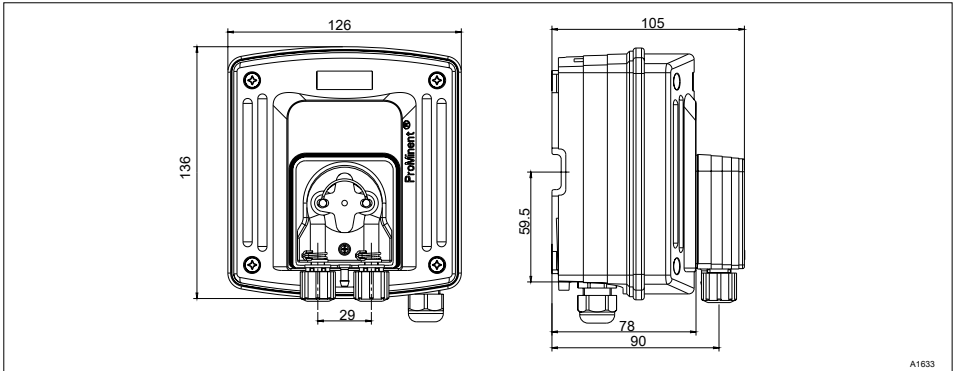

Fig. 8: Dimension sheet for DF2a

10 EU Declaration of Conformity for Machinery

In accordance with DIRECTIVE 2006/42/EC OF THE EUROPEAN PARLIAMENT AND OF THE COUNCIL, Appendix I, BASIC HEALTH AND SAFETY REQUIREMENTS, section 1.7.4.2. C.

We,

- ProMinent GmbH
- Im Schuhmachergewann 5 - 11
- DE - 69123 Heidelberg,

hereby declare that the product specified in the following, complies with the relevant basic health and safety requirements of the EC Directive, on the basis of its functional concept and design and in the version distributed by us. Any modification to the product not approved by us will invalidate this declaration.

Designation of the product:	Peristaltic Pump DULCO®flex DF2a
Serial number:	see nameplate on the device
Relevant EU directives:	Machinery Directive (2006/42/EC) EMC Directive (2014/30/EU) Compliance with the protection targets of the Low Voltage Directive 2006/95/EC according to Appendix I, No. 1.5.1 of the Machinery Directive 2006/42/EC RoHS Directive (2011/65/EU)
Harmonised standards applied, in particular:	EN ISO 12100:2010 EN 809:1998 + A1:2009+AC:2010 EN 61010-1:2010 EN 50581:2012 EN 61000-6-2:2005 + AC:2005 EN 61000-6-3:2007+A1:2011+AC:2012
Place, Date:	Heidelberg, 20.04.2016

11 Index

A

- Action, step by step 2
- Ambient conditions 14
- Ambient temperature 14
- Applied harmonised standards . . . 34

C

- Changing the pump hose 24

D

- Declaration of Conformity 34
- Designation of the product 34
- Device components 15

F

- Fixing materials 16
- Fragrance metering 29
- Functional description 15

G

- General information on installation and assembly 16
- General non-discriminatory approach 2

I

- Installation 16

L

- Links to elements or sections of these instructions or other applicable documents 2

M

- Maintenance: After extended periods of idleness 23
- Maintenance: approx. annually . . . 23
- Maintenance: approx. every six months 23
- More symbols 2

N

- Non-discriminatory approach 2

P

- Pipe assembly 17
- Pipe diameter: 25 mm to 60 mm. . 17

Q

- Question: Where can I find the Declaration of Conformity? 34
- Question: Which standards are complied with? 34

R

- Relevant EU directives 34

S

- Serial number 34
- Standards complied with 34

T

Transparent cover 22

U

Users' qualifications 12

W

Wall mounting 16

Warning information 8

Washer 16



ProMinent GmbH
Im Schuhmachergewann 5 - 11
69123 Heidelberg, Germany
Germany
Telephone: +49 6221 842-0
Fax: +49 6221 842-419
Email: info@prominent.com
Internet: www.prominent.com

984881, 2, en_GB