

Product catalogue 2020

Water Treatment and Disinfection



Issued by:

ProMinent GmbH
Im Schuhmachergewann 5-11
69123 Heidelberg
Germany
Phone +49 6221 842-0
info@prominent.com
www.prominent.com



Technical changes reserved.

All previous catalogues and price lists are superseded with the release of this product catalogue.
You can view our general terms and conditions on our homepage.

Heidelberg, January 2020

Water treatment and water disinfection



One-stop technology-independent solutions

Chapter 1

UV systems for gentle and chemical-free water treatment. They are ideal for the disinfection of municipal potable water or product water in the beverage industry. UV systems ensure totally carefree swimming fun without troublesome combined chlorine in swimming pool water treatment.

Ozone systems are the optimum solution if undesirable organic or inorganic substances need to be effectively removed. The reactive ozone provides efficient disinfection without the formation of by-products. It simply decomposes in water to form oxygen.

Electrolysis systems generate chlorine in a chemical-free manner on site from salt and current. There is therefore no need for the transport and storage of potentially hazardous chemicals and the chlorine products are precisely produced when they are needed. ProMinent electrolysis systems generate chlorine gas for swimming pool disinfection, hypochlorite for potable water treatment and hypochlorous acid for disinfection in the food industry.

Systems for chlorine gas metering DULCO®Vaq stand out on account of particularly economic operation even with very high capacities. Vacuum technology means that chlorine gas systems are reliable and robust and are used globally in potable water and in swimming pool water treatment.

Chlorine dioxide offers long-lasting microbiological protection, for instance of long pipework in potable water treatment. It can also be used in the most diverse applications in the food industry, for instance bottle rinsers, process water, CIP (cleaning in place).

Chapter 2

Metering systems Ultromat® win customers over with their ease of assembly and operation. They meet the ultimate requirements in terms of the separation of colloidal solids from liquids.

Storage tanks are indispensable. They comply with internationally applicable manufacturing approvals and are suitable for installation outdoors and indoors.

Chapter 3

Diaphragm systems are indispensable if particles or dissolved substances, such as salts, need to be removed from the water. Combined with the ProMinent product range, you obtain complete water treatment solutions from a single supplier.

Ready for you. Anytime, anywhere.

ProMinent is close to hand no matter where you are: 55 dedicated sales, production and service companies guarantee service and availability in close proximity to our customers. For many years this has meant a local presence for our customers in over 100 countries.

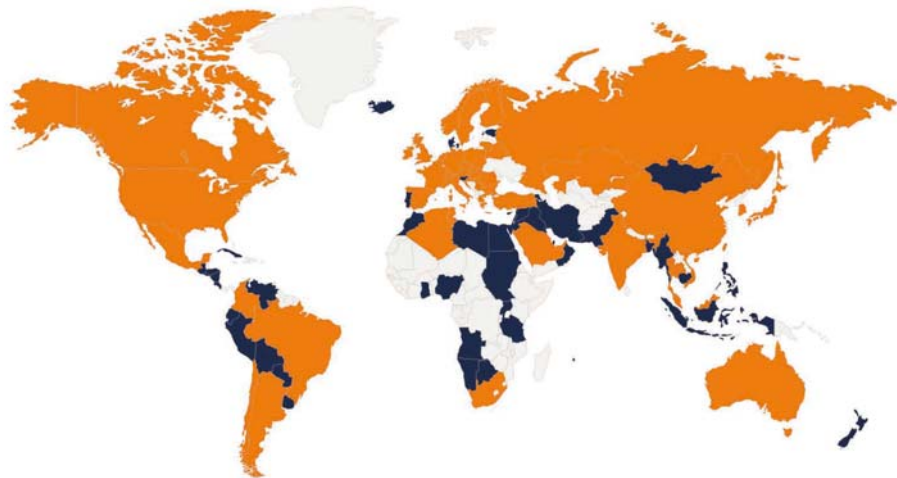

Our sales team will be happy to be of assistance should you have any questions about metering technology or water treatment. You will find the contact details of your local contact at www.prominent.com/en/locations.

Pump Guide

You can also find information online. The ProMinent pump selection guide is available on our website. Just enter the required pump capacity and back pressure, and the Pump Guide will show you a list of suitable metering pumps. This is the quick and easy way to track down precisely the right pump for your needs.

www.pump-guide.com

New Products Water Treatment and Water Disinfection



Chlorine dioxide system Bello Zon® CDKd



15 – 12,000 g/h chlorine dioxide. The maximum volume of water that can be treated with metering of 0.2 ppm ClO₂, depending on the size of the system: 60,000 m³/h

There is an intrinsically safe pre-dilution station for concentrated hydrochloric acid in this chlorine dioxide system. The consumption of hydrochloric acid can therefore be automatically adapted on site to the individual operating conditions by means of a patented process. Savings of up to 20%.

The system control stands out on account of its user-friendly menu guidance and ensures the precise production of chlorine dioxide. The chemicals are mixed perfectly in a reactor made of food-safe PVDF. You thereby benefit from maximum output with the lowest possible consumption of chemicals and maximum operating safety. Communication via popular bus systems, via web server and our DULCOnneX platform fulfils all the requirements set by the Industry 4.0 standards of tomorrow.

The construction and operating mode of the system also complies with all requirements of DVGW specifications W 224 and W 624 and the system is intended for operation with concentrated chemicals Bello Zon® chlorite (24.5% NaClO₂) and acid (25 – 37% HCl). The liquid levels of the starting chemicals can either be displayed and monitored by external liquid level sensors or by patented adaptive liquid level monitoring.

- Cost savings through optimised acid consumption
- Various communication options via BUS, web server or DULCOnneX
- System does not stop due to empty starting feed chemical tanks, thanks to precise level indicator displays
- Ultra-simple and safe operation thanks to intuitive menu guidance
- Cost-effective operation due to the use of inexpensive, concentrated starting chemicals
- Location-independent system monitoring in real time via the DULCOnneX platform: Improved process reliability. Reliability and transparency due to real-time monitoring, individual alarms and automated reports.
- Maximum operating safety and purity of the ClO₂ produced by PVDF reactors and three-stage safety concept
- Automatic monitoring of operating parameters and maintenance intervals

For more information see page → 1-66



New Products Water Treatment and Water Disinfection



Chlorine dioxide system Bello Zon® CDVd

5 – 2,000 g/h of chlorine dioxide. Maximum volume of water that can be treated with metering of 0.2 ppm ClO₂, depending on the size of the system: 50 - 10,000 m³/h

The chlorine dioxide system CDVd is very user-friendly. The system control stands out due to its intuitive menu guidance and ensures the precise production of chlorine dioxide. The special reactor concept generates chlorine dioxide safely and simply. Chemically resistant PVDF is used instead of the PVC generally used within the industry. You benefit from maximum output with the lowest possible consumption of chemicals combined with the maximum operating safety. Communication via popular bus systems, via web server and our DULCO^{ne}X platform fulfils all the requirements set by the Industry 4.0 standards of tomorrow.

The system meets all the requirements of the DVGW specifications W 224 and W 624 with regard to construction and operation and is intended for operation with diluted chemicals Bello Zon® chlorite (7.5% NaClO₂) and acid (9% HCl). The liquid levels of the starting chemicals can either be displayed and monitored by external liquid level sensors or by an adaptive liquid level monitor that is patent pending.

- Maximum operating safety and purity of the ClO₂ produced by PVDF reactors and three-stage safety concept
- Various communication interfaces via BUS, web server or DULCO^{ne}X
- Ultra-simple and safe operation thanks to intuitive menu guidance
- System does not stop due to empty starting feed chemical tanks, thanks to precise level indicator displays
- Automatic monitoring of operating parameters and maintenance intervals
- Location-independent system monitoring in real time via the DULCO^{ne}X platform: Improved process reliability. Reliability and transparency due to real-time monitoring, individual alarms and automated reports.

For more information see page → 1-62

Electrolysis system CHLORINSITU® IIa 60 – 2,500 g/h

Output 60 – 2,500 g/h of chlorine

The CHLORINSITU® IIa product range combines the proven and durable design of the undivided electrolysis cell with an innovative design. An exceptional quality of hypochlorite solution is achieved when the salt and power output is increased. The chlorate content of the product is significantly below the limit value specified in EN 901.

The electrolysis system is perfectly equipped for all safe water disinfection with an increased capacity of up to 2,500 g of chlorine per hour.

All relevant system components are accommodated in a space-saving housing. Integral hydrogen drainage enables the system to be installed without any need for additional ventilation requirements at the installation site.

The softener and a 50-litre product storage tank are installed in the system housing with systems up to 300 g/h. An integral metering pump circulates the chlorine from the storage tank directly to the application or into a larger storage tank.

An H₂ deaerator dissolves the hydrogen directly from the hypochlorite with systems above 625 g/h. The hydrogen-free product is pumped by an integral pump into an external product storage tank. The product pump is also capable of pumping along height differences of up to 7 m. Customised metering stations supply the points of injection.

The external product storage tank does not require additional hydrogen bleeding. There are therefore no additional costs relating to installation and operation.

The system is immediately ready for use, thanks to its plug-and-play concept. Operation of the electrolysis system has been consciously kept simple.

- durable design, reliable technology
- low-chlorate product (below the EN 901 limit value)
- high output: only 3.0 kg of salt per kg of chlorine
- reduced energy requirement: only 4 kWh/kg chlorine
- no need for an additional fan for the product storage tank
- minimal maintenance work and ease of operation

For more information see page → 1-83



New Products Water Treatment and Water Disinfection

Electrolysis system CHLORINSITU® Ila XL



Output 5 – 45 kg/h of chlorine

The new CHLORINSITU® Ila XL is specially developed to meet the requirements of large-capacity in situ potable water disinfection. Based on the recently developed tubular cells, the system is a modular system for the safe production of hypochlorite solution from a diluted salt solution. Thanks to its precise production and optimised cell design, it achieves a high turnover of salt at a concentration of 8 g/l in the final product. The certified safety concept ensures the safe extraction of hydrogen and maximum operating safety. The CIIa XL is combined with the necessary modules, depending on the needs of the project, and is adapted as best as possible to the conditions on site.

- Sole use of salt as the raw material
- Very long service lives due to minimal maintenance and robust technology
- Proven cell design with increased efficiency, only 3.2 kg NaCl/kg free chlorine
- Modular design
- Easy accessibility
- Certified safety
- Safe and reliable hydrogen discharge

For more information see page → 1-86

Metering and drainage station DULCODOS® SAFE-IBC



Storage and drainage of IBCs up to 1,000 l – metering of chemicals up to 1,000 l/h

DULCODOS® SAFE-IBC is a special metering and drainage station for Intermediate Bulk Containers (IBC) with almost complete residual drainage.

The IBC is positioned and fixed at the customer's side on the respective installation surface of the collecting pan slightly tilted forward. Featuring leak-proof safety couplings and hoses, the IBC is connected to an approx. 200-litre interim tank fitted to the left side of the collecting pan. Alternatively, the station can be ordered with a standpipe and tank volume of approx. 60 litres.

When changing the IBC, this buffer volume ensures an interruption-free process. The IBC change can also be planned better with a visual level indicator and a liquid level measurement with alarm message. The station is equipped with an inspection opening for maintenance purposes.

A compact metering station can be integrated in the front of the interim tank depending on process requirements for reliable metering. It is equipped either with one or two solenoid-driven metering pumps or with one motor-driven metering pump.

Larger metering stations can be configured as required and designed for side mounting on the wall or installation on the floor.

- Maximum operating safety:
- Excellent process reliability due to interruption-free metering in the process.
- Safe installation of an IBC on a special roll-under collecting pan construction. Any drops are reliably collected and cannot escape at the installation place.
- Almost complete residual drainage of the IBC.
- Interim tank with a volume of approx. 200 litres combined with an integrated metering station.
- Collecting pan based on general building authority certification by the German Institute of Building Technology (applied for).

For more information see page → 2-29



New Products Water Treatment and Water Disinfection



Metering system Ultramat® ULLa (inline system liquid)

Extraction volume 50 – 2,000 l/h against 3-6 bar

The metering system Ultramat® ULLa is a compact inline batching station. It features a special mixing chamber in which liquid polymer is added by peristaltic or metering pumps. Optimum mixing with water produces a matured and fully activated polymer solution. An additional maturing tank with stirrer and feed pump can be installed downstream to create a batch preparation station.

The concentration of the polymer solution can be simply adjusted on the touch panel.

Optionally continuous polymer batch output in l/h can be specified. The polymer batching system works reliably and conserves resources, thanks to its optimum process control.

- precise processing of liquid polymers (0.05 – 1.5%)
- highly efficient mixing chamber for emulsions / dispersions and water
- user-managed input of the concentration with proportional metering
- compact design with various installation options
- optional operator-managed specification of the polymer batching output in l/h

For more information see page → 2-14



DULCOnneX – the total solution for your digital fluid management

ProMinent's DULCOnneX is the smart overall solution for digitally networking your system components. The DULCOnneX is based on robustly networked products that can be individually adapted to operating conditions. As all the components of a system are networked, metering pumps, disinfection systems, controllers and sensors can interact in an optimised manner – increasing process reliability and system efficiency.

Location-independent system monitoring in real time

You always have all the key data and measured values about your pump installations in sight at all times with DULCOnneX. Monitor the status of your system in real time and benefit from continuous documentation. Check your unit data safely and reliably when you're out and about. Simply use the terminal device of your choice: smartphone, tablet or PC. Configurable alarms and messages inform you of relevant events 24/7.

Be in a position to act promptly at all times with DULCOnneX. Whether industrial and process water, cooling water, potable water or swimming pool water – DULCOnneX supports you in ensuring the reliable treatment of your fluids.

DULCO[®]neX – the total solution for your digital fluid management

1	Disinfection Systems and Oxidation Systems	1-1
1.1	UV Systems Dulcodes	1-1
1.1.1	General Notes on UV Treatment	1-1
1.1.2	Performance Overview of Dulcodes UV Systems	1-4
1.1.3	Questionnaire for Designing an UV System	1-6
1.1.4	UV System Dulcodes LP	1-7
1.1.5	UV System Dulcodes LP certified	1-9
1.1.6	UV System Dulcodes LP F&B	1-11
1.1.7	UV System Dulcodes LP-PE Plastic	1-13
1.1.8	UV System Dulcodes MP	1-15
1.1.9	UV System Dulcodes A	1-17
1.1.10	Accessories for Dulcodes UV Systems	1-19
1.1.11	DULCO [®] neX – digital fluid management	1-22
1.2	Ozone Systems OZONFILT [®]	1-23
1.2.1	Ozone in Water Treatment	1-23
1.2.2	Performance Overview of Ozone Systems	1-24
1.2.3	Questionnaire on the Design of an Ozone System	1-25
1.2.4	Ozone system OZONFILT [®] OZVb	1-26
1.2.5	System Solution OZONFILT [®] Compact OMVb	1-30
1.2.6	Ozone System OZONFILT [®] OZMa	1-32
1.2.7	Accessories and Spare Parts for Ozone Systems	1-41
1.2.8	DULCO [®] neX – digital fluid management	1-48
1.3	Bello Zon [®] Chlorine Dioxide Systems	1-49
1.3.1	Chlorine Dioxide in Water Treatment	1-49
1.3.2	Performance Overview of Chlorine Dioxide Systems	1-51
1.3.3	Questionnaire on the Design of a Chlorine Dioxide System	1-52
1.3.4	Chlorine Dioxide System Bello Zon [®] CDLb	1-53
1.3.5	Chlorine Dioxide System Bello Zon [®] CDLb with Multiple Points of Injection	1-59
1.3.6	Chlorine Dioxide System Bello Zon [®] CDEb	1-60
1.3.7	Chlorine dioxide system Bello Zon [®] CDVd	1-62
1.3.8	Chlorine dioxide system Bello Zon [®] CDKd	1-66
1.3.9	Storage Tank Accessories	1-70
1.3.10	Bypass Line Accessories	1-71
1.3.11	Chemical Supply Accessories	1-74
1.3.12	Safety Accessories and Analysis	1-76
1.3.13	DULCO [®] neX – digital fluid management	1-79
1.4	Electrolysis Systems CHLORINSITU [®] and DULCO [®] Lyse	1-80
1.4.1	Electrolysis Systems CHLORINSITU [®]	1-80
1.4.2	Performance Overview	1-81
1.4.3	Questionnaire on the Design of an Electrolysis System	1-82
1.4.4	Electrolysis system CHLORINSITU [®] IIa 60 – 2,500 g/h	1-83
1.4.5	Electrolysis system CHLORINSITU [®] IIa XL	1-86
1.4.6	Electrolysis System CHLORINSITU [®] III	1-88
1.4.7	Electrolysis Systems CHLORINSITU [®] III Compact and IV Compact	1-90
1.4.8	Electrolysis System CHLORINSITU [®] V	1-94
1.4.9	Electrolysis System CHLORINSITU [®] V Plus	1-96
1.4.10	Questionnaire on the Design of a DULCO [®] Lyse Electrolysis System	1-98
1.4.11	Electrolysis System DULCO [®] Lyse	1-99
1.4.12	Accessories	1-101
1.5	Chlorine Gas Metering Systems DULCO [®] Vaq	1-103
1.5.1	General Information on Chlorine Gas Metering Systems	1-103
1.5.2	Performance Overview of Chlorine Gas Metering Systems DULCO [®] Vaq	1-104
1.5.3	Questionnaire on the Design of a Chlorine Gas Metering System	1-105
1.5.4	Vacuum controller for chlorine gas DULCO [®] Vaq	1-106
1.5.5	Motor-Driven Control Valve for Chlorine Gas DULCO [®] Vaq	1-109



Water Treatment and Water Disinfection

page

1.5.6	Manual Chlorine Gas Metering Unit DULCO®Vaq PM3720 C	1-111
1.5.7	Automatic Chlorine Gas Metering System DULCO®Vaq	1-112
1.5.8	Chlorine Gas Metering System DULCO®Vaq	1-114
1.5.9	Vacuum Switch-Over for Chlorine Gas DULCO®Vaq	1-116
1.5.10	Pressure Switch-Over for Chlorine Gas DULCO®Vaq	1-118
1.5.11	Injector for Chlorine Gas DULCO®Vaq	1-119
1.5.12	Flow Meter for Chlorine Gas DULCO®Vaq	1-121
1.5.13	Automatic Emergency Shut-Off System for Chlorine Gas DULCO®Vaq	1-122
1.5.14	Evaporator for Chlorine Gas DULCO®Vaq	1-124
1.5.15	Neutraliser for Chlorine Gas DULCO®Vaq	1-125
1.5.16	Accessories for Chlorine Gas Metering	1-126
1.5.17	Accessories for Room and Safety Equipment	1-129
1.5.18	Other Accessories	1-132
1.5.19	Personal Safety Equipment	1-134
2	Metering Systems	2-1
2.1	Polymer Preparation and Metering Systems Ultromat®, PolyRex and POLYMORE	2-1
2.1.1	Polyelectrolytes in Water Treatment	2-1
2.1.2	Performance overview of polymer batching and metering systems Ultromat® and PolyRex	2-2
2.1.3	Questionnaire for the design of polymer batching and metering systems Ultromat® and PolyRex	2-3
2.1.4	Preparation stations and metering of powdered and liquid polymer solutions Ultromat®	2-4
2.1.5	Metering System Ultromat® ULFa	2-5
2.1.6	Metering System Ultromat® ULPa	2-8
2.1.7	Metering System Ultromat® ULDa	2-11
2.1.8	Metering system Ultromat® UL1a (inline system liquid)	2-14
2.1.9	Metering System Ultromat® MT for Batch Operation	2-17
2.1.10	Ultromat® Accessories including Big Bag Systems	2-18
2.1.11	Batching stations and metering of powdered and liquid polymer solutions PolyRex	2-21
2.1.12	Metering System PolyRex	2-22
2.1.13	Metering System PolyRex Big Bag	2-24
2.1.14	Metering System PolyRex Liquid	2-26
2.1.15	PolyRex Accessories – Mixing Systems	2-27
2.1.16	Multi-Screw Feeder TOMAL®	2-28
2.2	Metering and drainage station DULCODOS® SAFE-IBC	2-29
2.2.1	Metering and drainage station DULCODOS® SAFE-IBC	2-29
2.3	Storage and process tanks	2-31
2.3.1	PE/PP storage tank, general	2-31
2.3.2	PE Storage Tank With General WHG Approval	2-32
2.3.3	Accessories according to the specifications of the Federal Water Act (WHG) and/or the Ordinance on installations for the handling of substances hazardous to water (VAWS)	2-34
2.3.4	Other Accessories	2-36
2.3.5	PP/PE process storage tank, customised	2-37

Water Treatment and Water Disinfection

page

3	Filtration	3-1
3.1	Overview of Membrane Technology	3-1
3.2	Ultrafiltration Systems	3-2
3.2.1	Performance Overview of Ultrafiltration	3-2
3.2.2	Questionnaire on the Design of a UF System	3-4
3.2.3	Ultrafiltration Systems Dulcoclean® UF	3-5
3.3	Nanofiltration Systems	3-6
3.3.1	Nanofiltration System Dulcosmose® NF	3-6
3.4	Reverse Osmosis Systems	3-8
3.4.1	Performance Overview of Reverse Osmosis	3-8
3.4.2	Questionnaire on the Design of an RO System	3-10
3.4.3	Reverse Osmosis System Dulcosmose® TW	3-11
3.4.4	Reverse Osmosis System Dulcosmose® BW	3-13
3.4.5	Reverse Osmosis System Dulcosmose® SW	3-15
3.5	Gravity Filters	3-17
3.5.1	Sand Filter INTERFILT® SK	3-17



DULCOneX – the total solution for your digital fluid management

Full transparency of water quality – any time, anywhere



Improved process safety, reliability and transparency due to real-time monitoring, individual alarms and automated reports.



ProMinent's DULCOneX is the smart overall solution for digitally networking your system components. The DULCOneX is based on robustly networked products that can be individually adapted to operating conditions. As all the components of a system are networked, metering pumps, disinfection systems, controllers and sensors can interact in an optimised manner – increasing process reliability and system efficiency.

Location-independent system monitoring in real time

With DULCOneX, you always have access to all key data and measured values of your installations. Monitor the status of your system in real time and benefit from continuous documentation. Check your unit data safely and reliably when you're out and about. Simply use the terminal device of your choice: smartphone, tablet or PC. Configurable alarms and messages inform you of relevant events 24/7.

Be in a position to act promptly at all times with DULCOneX. Whether potable water, waste water, industrial and process water, cooling water or swimming pool water – DULCOneX supports you in ensuring the reliable treatment of your fluids.

Reference Water Work

The aim of water treatment is the removal of potential hazardous substances from the water and, at the same time, the addition of substances for purifying purposes. Our metering pumps and measuring and control systems enable the addition of chlorine, chlorine dioxide, ozone and flocculants, etc., to the water circuit. DULCOneX enables you to view all the key parameters such as pH, chlorine and ozone content or conductivity, at any time and from anywhere.

DULCOneX also continuously logs the operating parameters of all connected components and makes them available to you in the form of value diagrams and summarised reports to ensure that you always retain an overview of your processes.

You can use individually configurable alarms to define key limit values, which may not be exceeded or undershot, ensuring that you are immediately informed in the event of a fault. This enables you to easily ensure, among other things, that the radiation intensity of your UV system is sufficient, that all metering pumps have metered correctly and that the measured water parameters meet all requirements.



DULCOneX – the total solution for your digital fluid management

Reference Hotel

Many factors are decisive for economic and hence successful operation of a hotel – one of them is clean and germ-free potable water.

Disinfection with chlorine dioxide offers a range of different benefits. Chlorine dioxide degrades biofilms in pipework and tanks, protecting your system against legionella attack. It also has a sustained-release effect due to its long-term stability in the piping system. Our chlorine dioxide systems also provide for disinfection independent of the pH value.

Connecting your disinfection systems and controllers to DULCOneX also provides you with automatic and continuous documentation of the process data recorded, enabling you to log hygiene-compliant operation of your systems conforming to the relevant regulations without the risk of tampering.

You can use individually configurable alarms to define key limit values, which may not be exceeded or undershot, ensuring that you are immediately informed in the event of a fault and do not need to keep checking on your devices in the interim.

That way, DULCOneX supports you with smooth and carefree water treatment in your hotels – your guests will thank you for it.

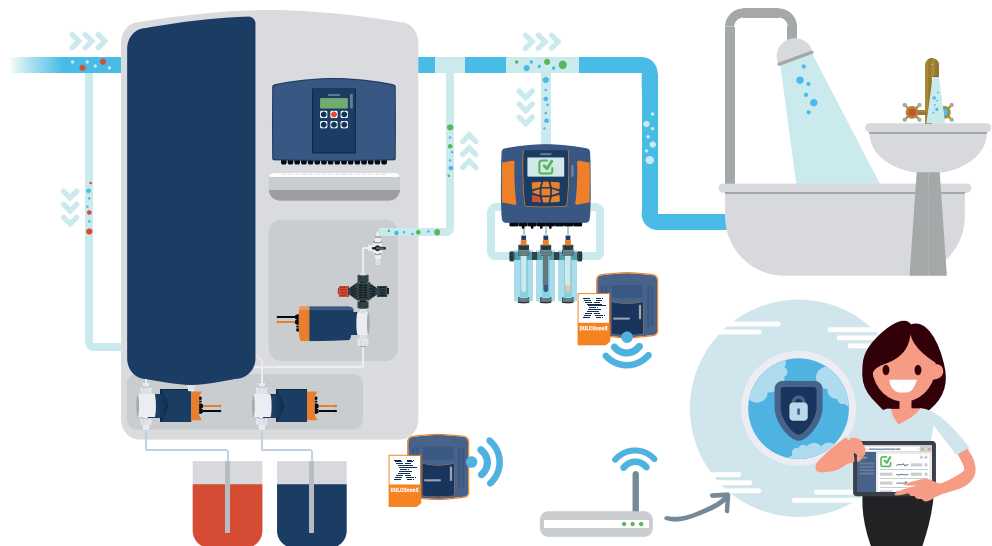

The benefits with DULCOneX



- **Complete overview of all your devices and installations** – any time and from anywhere.
- **Reliable saving of your complete value history** including alarms and warnings that occur.
- **Individual alarms by e-mail** – Keep up to date at all times.
- **Continuous logging and automatic reports** – Documentation and evidence of correct operation.
- **Clear visualisation** – Graphic display of value and parameter combinations.
- **Access via the web** – Simply use any of your smart devices with an installed browser. You do not need an additional app nor a permanent link to the connected device.

The DULCOneX platform can be accessed at <https://dulconnex.prominent.com>. Please contact us for a demonstration and e-mail your questions directly to us at dulconnex@prominent.com. We'd be delighted to help you further.



DULCO[®]neX – the total solution for your digital fluid management



Privacy and data security

The architecture of DULCO[®]neX is already designed to achieve maximum safety and reliably protect your data. For example, there is a systematic separation of user-specific data and measured values. In addition, all measured values are anonymised internally and the entire system is regularly inspected by professional IT safety service providers for possible safety gaps.

Examples of relevant safety measures:

- Encryption in accordance with the latest state of the art
- Multiple redundant data memories
- Systematic control of the equipment ownership

Constantly growing portfolio of supported devices

We are continuously working at full throttle to extend our range of solutions. Below are just some of the devices and systems supported as standard to date. We also support the connection of additional components via flexibly combinable modules with digital or analogue inputs. This enables older devices to be connected (such as the chlorine dioxide system Bello Zon[®] CDLb) or other manufacturers' components (e.g., liquid level gauges, water meters, gas detectors).

- **Disinfection systems**
 - UV systems Dulcodes LP/MP
 - Chlorine dioxide system Bello Zon[®] CDKd and CDVd
- **Pumps**
 - gamma/ X
 - gamma/ XL
 - DULCO flex Control – DFXa
 - DULCO flex Control – DFYa
 - Sigma X
 - DULCO[®]flex DF4a
 - delta[®]
- **Controllers**
 - AEGIS II / SlimFLEX 5a
 - DULCOMETER[®] diaLog DACb
- **Standard signals via dedicated modules**
 - Digital inputs (relays, also with counter)
 - Analogue inputs (4...20 mA)

DULCO[®]neX gateway

Our DULCO[®]neX gateway enables all smart products to be connected to our web-based fluid management platform.

The prerequisite for the correct operation of DULCO[®]neX is a "DULCO[®]neX gateway" compatible with the relevant product, which communicates with the "DULCO[®]neX platform" via a Wi-Fi internet connection provided by the customer.



	Devices	Order no.
DULCO[®]neX gateway AGIb	AEGIS II	1098723
DULCO[®]neX gateway DACb	DULCOMETER [®] diaLog DACb	1098756
DULCO[®]neX gateway DLT, GMX, GXL	gamma/ X, gamma/ XL, delta [®] , DULCO [®] flex DF4a, DULCO flex Control DFXa, DULCO flex Control DFYa, I- und M-Modul (DULCOMARIN [®] II), Frenzel+Berg Module (CIO50, CIO57, CIO58, CIO60, CIO300), Sigma X	1098754
DULCO[®]neX gateway DF4, SXCB	gamma/ X, Sigma X, DULCO [®] flex DF4a	1098755
DULCO[®]neX gateway UVCb	Dulcodes LP/MP, gamma/ X, Sigma X	1098757



DULCOⁿⁿeX – the total solution for your digital fluid management



1 Disinfection Systems and Oxidation Systems

1.1 UV Systems Dulcodes

1.1.1 General Notes on UV Treatment

Disinfection is a key stage in modern water treatment. UV disinfection is used to an ever increasing extent, as a safe, chemical-free and reliable disinfection process. Extensive research projects and numerous trouble-free operational systems prove the safety and reliability of UV disinfection.

With UV disinfection, the water to be disinfected is exposed to ultraviolet light, which involves a purely physical, chemical-free process for water disinfection.

UV-C light in particular, with a wavelength ranging from 240 to 280 nm, attacks the vital DNA of the bacteria directly. The radiation initiates a photochemical reaction and destroys the genetic information contained in the DNA. The germ loses its reproduction capability and is destroyed. Even parasites, like Cryptosporidia or Giardia, which are extremely resistant to chemical disinfectants, are efficiently inactivated.

Photochemical reactions are triggered in other applications too. The undesirable disinfection by-product in swimming pool water is reduced by UV radiation, as a result of which enormous fresh water savings are achieved. Oxidants, such as ozone, chlorine or chlorine dioxide, are reliably reduced in the production water used in the food and beverage industry, avoiding the need for costly activated charcoal filters.

UV disinfection has many advantages:

- Immediate and safe destruction of germs without the addition of chemicals
- Photochemical reduction of undesirable substances
- No THM or AOX formation, no formation of other undesirable substances
- No impairment of the odour or taste of the water
- No storage and handling of chemicals required
- Effect is independent of pH
- No reaction vessel or reaction tank required
- Minimal space requirement
- Low investment and operating costs with excellent reliability and efficiency

Applications of Dulcodes UV Systems

A large number of our UV disinfection systems have been supplied worldwide, for the most diverse of applications:

- **Private water suppliers and municipal water works**
for the disinfection of potable water
- **Food and beverage industry**
to destroy the germs and bacteria in the water needed for food and beverage production and for the disinfection of process water
for the reduction of chlorine dioxide, ozone or chlorine in product water
for the disinfection of sugar syrup
- **Pharmaceutical and cosmetics industry**
to meet the high microbiological requirements of the production water
to destroy residual ozone in the production water without the use of active carbon filters
- **Reverse osmosis systems**
for permeate disinfection
- **Horticulture**
for the disinfection of irrigation water
- **Spa pools and swimming pools**
for the disinfection of the pool water
for chloramine reduction in the pool water



1 Disinfection Systems and Oxidation Systems

Description of Dulcodes UV Systems

Dulcodes UV disinfection systems essentially consist of:

- High-quality reactor made of stainless steel (DIN 1.4404) or UV-resistant plastic
- Lamp protection tubes made of high-quality quartz, easily removable for cleaning purposes
- Lamps with an exceptionally high UV output in the 254 nm range
- Highly selective UV sensors with good long-term and temperature stability
- UV system controllers and modern electronic ballasts fitted in a control cabinet

The special features of our Dulcodes UV disinfection systems are:

- Uniform UV dose distribution thanks to optimised flow characteristic in the reactor guarantees maximum flow output with a minimum lamp count and minimum pressure loss
- Reduced life cycle costs due to the long life time of high-output lamps with low energy consumption and high UV output
- Unique active temperature management of Vario-flux low-pressure technology adapts the lamp output in seconds and provides optimum disinfection even with rapidly changing flows and temperature conditions
- Efficient and chemical-free cleaning of the lamp protection tubes with manual or automatic wiper system without interruption to operation
- Continuous monitoring of the reactor temperature by temperature sensor Pt 1000
- Electronic ballasts for the soft start and operation and monitoring of individual lamps
- Dulcodes LP control cabinet with efficient recirculation cooling ensures the long life of electronic components and protects against corrosion in aggressive ambient conditions
- Various options for simple integration of the unit in higher-level control systems thanks to many analogue and digital interfaces
- User-friendly and intuitive control for the display of operating statuses and adjustment of operating parameters
- Comprehensive biosimetric validation in line with EPA-UVDGM or DVGW and ÖVGW certification for selected product ranges confirm disinfection efficiency

Dulcodes UV Lamps

Low-pressure lamp Vario-Flux

Newly developed patented high-output amalgam lamp with a guaranteed expected lamp life of 14,000 operating hours (pro rata). The lamps stand out on account of their high UV output and minimal ageing behaviour. Thanks to the unique combination of electronic ballast technology and the Vario-Flux lamps, they can be controlled quickly and precisely over a broad range of up to 50 % of the nominal power. Seasonal fluctuations of water temperature no longer play a role and are simply compensated for by the active temperature management of the lamp. Efficiency increases even in dimmed mode. This has a particularly positive effect when the actual flow is below the maximum possible flow of the system. The special technology also enables vertical and horizontal installation.

Medium-pressure lamp Powerline

Medium-pressure mercury lamp with a life expectancy of approx. 8,000 to 10,000 operating hours, depending on the lamp size. The high output of these lamps permits the treatment of very large flows. Thanks to their broad range spectrum, these lamps are particularly suitable for photochemical processes. The operating temperature of the lamps is 650 – 850 °C. The water temperature is therefore monitored and the system switches off when a limit temperature is exceeded.



1 Disinfection Systems and Oxidation Systems

Dulcodes UV Controllers

Compact controller

Compact unit for the control of all functions of the UV system. The control can be selected for single lamp systems of the Dulcodes LP product range. The display alternately shows the current UV-intensity, the operating hours and the number of lamp activations. The compact controller informs the operator if values fall below freely programmable safety and warning thresholds. Different functions, such as start rinsing, interval rinsing, stagnation rinsing and post-burning time can be freely set on demand.

The control has the following inputs and outputs:

- Connection for both a rinsing and shut-off valve (230 V)
- Potential-free contact output for the end of lamp life, power failure and warning
- Potential-free changeover output for operating and collective failure messages
- Potential-free contact input for temperature or flow control and pause
- 4-20 mA analogue output for sensor signal

Comfort controller UVCb

The Comfort controller consists of a control PCB and a HMI which is integrated in the door of the control cabinet. The control of the UV systems is user-friendly and intuitive. All operating statuses are shown on the display and all operating and fault messages are shown in plain text. The operating status (Operation/Warning/Fault) of the system can be seen from afar by means of LEDs.

The Comfort controller UVCb is connected to the ballasts via a bus system so that each individual lamp can be precisely monitored. Different cable lengths are detected automatically and the operating parameters adapted accordingly. The controller, the electronic ballasts and the lamps are perfectly matched to each other. This enables the system to adapt the UVC-output of the low pressure and medium pressure lamp to variable water quality or flow rates via an external 0/4-20 mA signal.

Different auxiliary functions, such as the automatic rinsing of the system over a freely programmable rinsing time, the control of a shut-off valve and a circulating pump are integrated as standard. The controller is managing as well the automatic wiper system. During the wiping cycle, the position is multiple controlled for absolute operational safety of the wiper system: by monitoring the end position and by continuous data exchange between the wiper motor and the controller.

The UVC sensor signal can be monitored online via an analogue output 0/4-20 mA. Any violation of the warning threshold, minimum radiation intensity and faults are reported via contact outputs. The reactor temperature is monitored by a temperature sensor to avoid overheating.

Potential-free inputs make it possible to hook up the UV-system to a higher order control: The "Pause" input can be used to regularly start/stop the system, with the "External fault" input leading to the system being shut down in the event of a fault with an external peripheral component connected. If the application requires different UV doses, a contact input can quickly adapt the UV dose to the changing requirement.

The Comfort controller UVCb features data logger. All events are saved on an SD card and can simply be read off on a PC. The UV sensor signal and other measuring parameters, connected to the control via external 0/4-20 mA signals, are stored on the SD card at set time intervals.

The control has the following inputs and outputs:

- 3 voltage outputs for rinsing and shut-off valve and pump (230 V or 24 V)
- 3 potential-free outputs for warning, collective malfunction and operating messages
- 4 potential-free inputs for pause, external fault, activate emergency mode, setpoint 1/2 switchover
- 1 analogue output 0/4-20 mA for sensor signal
- 2 analogue inputs 0/4-20 mA for flow and turbidity or combined chlorine with limit value function
- CAN-bus interface for the integration of higher-level controls

Dulcodes A comfort controller

A Siemens S7- 1200 control with a KP 300 Basic operating unit is used for operation and control of Dulcodes A systems. The functionality corresponds to that of the Comfort controller UVCb.



1 Disinfection Systems and Oxidation Systems

1.1.2 Performance Overview of Dulcodes UV Systems

ProMinent offers a wide range of UV systems for the most diverse applications. The following overview shows the capacity and main applications of our standard systems:

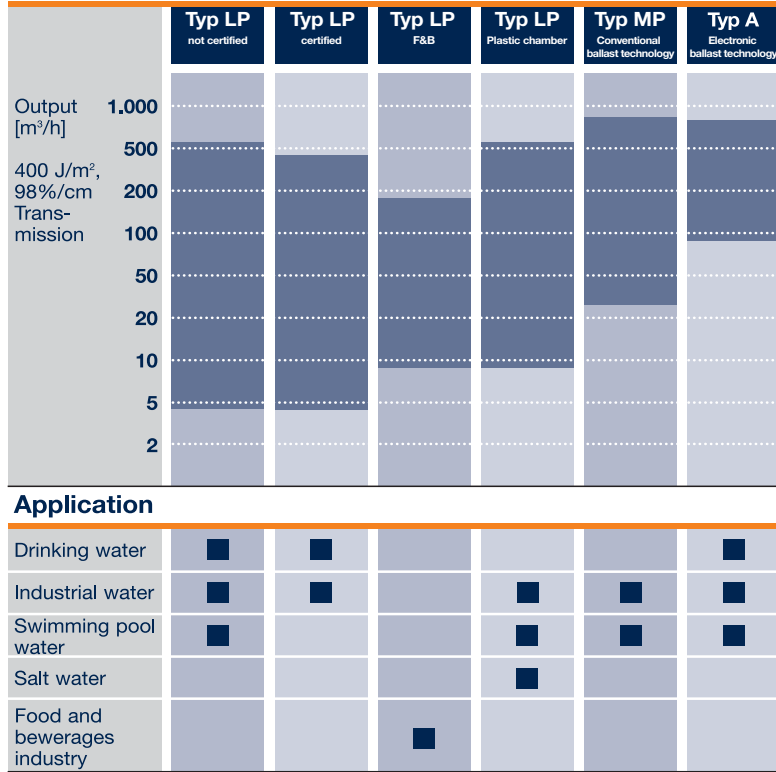

P_PMA_DS_0035_C

Type LP: Low pressure

Type MP: Medium-pressure

ProMinent provides all the advice needed for the safe operation of a Dulcodes UV system:

- Evaluation of the situation on site by trained, expert field sales staff.
- Project planning of the system.
- Commissioning and system maintenance by our trained service technicians.



1 Disinfection Systems and Oxidation Systems

Notes on Planning and Designing an UV System

- The system should always be designed for the greatest water flow.
- The system should always be designed for the lowest expected UV transmission.
- Provide fireproof sampling taps for microbiological upstream and downstream of UV disinfection systems.
- Provide a manual shut-off valve upstream of the UV system to isolate the system for maintenance work.
- Provide an electrically controlled shut-off valve downstream of the UV disinfection system for drinking water disinfection and similar applications, which also closes automatically in the event of mains power failure (solenoid valve, automatic closing flap valve or similar).
- With process water disinfection, it is normally sufficient to provide a manual valve to isolate the system for maintenance work, instead of an electrically controlled valve.
- Provide a rinse valve downstream of UV disinfection with drinking water disinfection and similar applications.
- It must be ensured that there is sufficient space available for removing the lamp protection tube and lamp replacement.

- 1 Shut-off valve
- 2 Sampling cock
- 3 Flushing valve
- 4 Shut-off valve
- 5 Controller/ballast
- 6 Radiation chamber

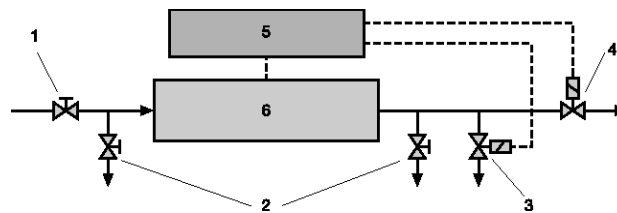

pk_7_059

Typical installation diagram of a UV disinfection system

The following details are required for design of a UV system:

- Application of the system
- Maximum water flow
- Minimum UV transmission of the water

The UV transmission should be determined by means of a laboratory measurement of the absorption at 254 nm.

A full water analysis gives important conclusions on the operating conditions of the system. The following questionnaire provides our project engineers with the information needed to design an appropriate system.



1 Disinfection Systems and Oxidation Systems

1.1.3 Questionnaire for Designing an UV System

Application of the UV system:

- for disinfection of
 - drinking water
 - production water in the food industry, cosmetics or pharmaceuticals
 - utility water
 - wastewater
 - salt water or brackish water
 - _____
- for photochemical reduction of
 - ____ ppm ozone
 - ____ ppm chlorine dioxide
 - ____ ppm chlorine
 - ____ ppm chloramine

Water data:

Maximum water flow _____ m³/h Maximum water pressure _____ bar

Minimum UV transmission at 254 nm _____ %/1 cm _____ %/10 cm _____ SAC 254 nm

Turbidity _____ FNU _____ NTU

Suspended particles content _____ mg/l

Water quality constant fluctuating

Total hardness _____ mmol/l _____ °dH

Carbonate hardness _____ mmol/l _____ °dH

Chloride _____ mg/l

Manganese _____ mg/l

Iron _____ mg/l

Water temperature _____ °C

Other requirements:

1



1 Disinfection Systems and Oxidation Systems

1.1.4

UV System Dulcodes LP

A world first: precise lamp dimming in seconds – even with varying flows and water temperatures.

Flow up to 523 m³/h

The unique UV systems Dulcodes LP are synonymous with pioneering water treatment – efficient and free of chemicals.

Our patented Vario-Flux high-output lamps with dynamic lamp heating are used in the Dulcodes LP. Thanks to the unique combination of electronic ballast technology and the Vario-Flux lamps, they can be quickly and precisely dimmed over a broad power range of up to 50% of the nominal electrical power. This ensures automatic adjustment to varying flows and water temperatures at all times.

Efficiency even increases in dimmed mode, which has a particularly positive effect when the actual flow is below the maximum possible flow of the system.

The flow in the Dulcodes LP has been optimised in a reactor based on intensive computer simulation. At the same time the pressure loss is kept minimal. The resulting uniform radiation dose without over- or under-metering of a partial volumetric flow leads to minimal use of energy, a minimum number of lamps and significantly reduced life cycle costs.

Your benefits

- UV system Dulcodes LP for a broad field of application for efficient, safe and chemical-free water disinfection
- Unique dynamic lamp heating adjusts the lamp output in seconds and provides for optimum disinfection even with rapidly varying flows and water temperatures
- Homogeneous UV dose, thanks to optimised flow behaviour in the reactor, guarantees maximum flow output with a minimum number of lamps and minimum pressure loss
- Reduced life cycle costs due to the long service life of Vario-Flux high-output lamps with low energy consumption and high UV output
- Excellent flexibility, thanks to vertical or horizontal installation and free choice of the flange position
- Location-independent system monitoring in real time via the DULCOnneX platform: Improved process reliability. Reliability and transparency due to real-time monitoring, individual alarms and automated reports.
- User-friendly and intuitive control for the display of operating statuses and adjustment of operating parameters
- Control cabinet with efficient recirculation cooling ensures the long life of electronic components and protects against corrosion in aggressive ambient conditions
- Data logger: all relevant operating data and events are saved on the SD card and can simply and conveniently be visualised with an analysis programme
- Simple remote monitoring and remote control of the system by means of web-based access via LAN/Wi-Fi interface

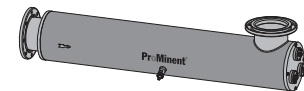

P_PMA_DS_0031_SW

Technical Details

- High-grade stainless steel 1.4404/AISI316L reactor hydraulically optimised by means of computer simulation
- High-output amalgam lamp "Vario-Flux" with dynamic lamp heating.
- Guaranteed lamp service life of 14,000 operating hours (pro rata)
- Electronic ballasts for the gentle ignition, operation and individual monitoring and control of the lamps
- Long-term stable UVC sensor for continuous monitoring of the system
- Efficient and chemical-free cleaning of the cover tubes with manual or automatic wiper system, optionally available for selected system sizes
- Continuous monitoring of the reactor temperature by temperature sensor Pt 1000
- Single lamp system: equipped with either a Compact controller or Comfort controller
- Various options for simple integration of the system in higher-level control systems thanks to many analogue and digital interfaces and connectors
- Data logger: all relevant operating data and all events are saved on the SD card and can simply and conveniently be visualised with an analysis programme
- Web server module enables simple remote monitoring and remote control of the system by means of web-based access via LAN/Wi-Fi interface. The current system status can be displayed at any time on a terminal unit

Field of application

- Potable water treatment
- Food and beverage production
- Swimming pool water



1 Disinfection Systems and Oxidation Systems

Design versions

The Dulcodes LP systems are available in the following design versions:

Type	Compact controller	Comfort controller	System control	Wiper	Stainless steel control cabinet	Air-conditioned control cabinet	NSF 50-certified	UL/CSA-compliant
Dulcodes 1 x 80 LP	Yes	No	No	No	No	No	No	No
Dulcodes 1 x 230 LP	Yes	Yes	Yes	No	Yes	Yes	Yes	Yes
Dulcodes 1 x 350 LP	Yes	Yes	Yes	Yes	Yes	Yes	Yes	Yes
Dulcodes 2 x 350 LP	No	Yes	Yes	Yes	Yes	Yes	Yes	Yes
Dulcodes 3 x 230 LP	No	Yes	Yes	No	Yes	Yes	Yes	Yes
Dulcodes 3 x 350LP	No	Yes	Yes	Yes	Yes	Yes	Yes	Yes
Dulcodes 4 x 350 LP	No	Yes	Yes	Yes	Yes	No	No	Yes
Dulcodes 6 x 350 LP	No	Yes	Yes	No	Yes	No	No	Yes

Technical Data

Type	Max. flow m ³ /h	Lamp power W	Connected load W	Reactor length mm	Minimum clearance for service mm	Ø mm	Connection nominal diameter DIN / ANSI
Dulcodes 1x80LP	8.8*	81	110	872	973	140	RP 2" / RP 2"
Dulcodes 1x230LP	35*	260	310	1,151	1,064	140	DN 80 / 3"
Dulcodes 1x350LP	53*	370	430	1,640	1,465	168	DN 100 / 4"
Dulcodes 2x350LP	123*	2x370	835	1,640	1,465	256	DN 150 / 6"
Dulcodes 3x230LP	155*	3x260	825	1,185	1,156	324	DN 150 / 6"
Dulcodes 3x350LP	232*	3x370	1,240	1,885	1,565	324	DN 200 / 8"
Dulcodes 4x350LP	317*	4x370	1,645	1,885	1,565	356	DN 200 / 8"
Dulcodes 6x350LP	523*	6x370	2,455	1,885	1,565	406	DN 250 / 10"

** 98 %/cm transmission; 400 J/m² irradiation intensity, calculated according to PSS.

Lamp type	Low-pressure lamp Vario Flux
Controller type	Comfort controller, optionally compact controller
Permissible operating pressure	10 bar or 16 bar
Permissible ambient temperature	5–40°C with comfort control, 5–35°C with compact control
Permissible water temperature	2 – 70 °C
Enclosure rating	IP 66

Low-pressure lamp Vario Flux (see p. → 1-2)

Spare Parts For Dulcodes LP UV Systems

	Order no.
UV lamp Vario Flux 80 W	1061751
UV lamp Vario Flux 230 W	1061752
UV lamp Vario Flux 350 W	1061418
Lamp protection tube for Dulcodes 1x80LP	1059182
Lamp protection tube for Dulcodes 1x230LP	1058838
Lamp protection tube for Dulcodes 1x350 and 2x350LP	1049344
Lamp protection tube for Dulcodes 3 – 6x350LP	1049350
O-ring lamp protection tube/lamp cover for 1x80LP	1004920
O-ring lamp protection tube for 1x230 to 6x350LP	1023569
UVC sensor	1075544
Screwed plug G 1/2" for Dulcodes 2 – 6x350LP	1005818
Screwed plug G 1/4" for Dulcodes 1x80 to 1x350LP	1002752
O-ring for G 1/4" screwed plug for Dulcodes 1x80 to 1x350LP	1001356
O-ring for G 1/2" screwed plug for Dulcodes 2 – 6x350LP	1002279

1 Disinfection Systems and Oxidation Systems

1.1.5

UV System Dulcodes LP certified

Global first in the chemical-free disinfection of potable water – now also certified

Flow up to 410 m³/h



UV system Dulcodes LP for potable water disinfection, comprehensively certified to internationally-recognised DVGW / ÖNORM / SVGW / ACS / UVDGM standards. Pioneering water treatment - highly efficient by Vario-Flux lamps with dynamic lamp heating.

The Dulcodes LP is the first UV system to be precisely dimmed over a wide temperature range.

The unique combination of electronic ballast technology and the Vario-Flux lamps enables the system to be quickly and precisely dimmed over a broad power range of up to 50%. It therefore automatically adapts to changing flows or changes of water temperature.

Maximum efficiency and minimal life cycle costs are therefore achieved due to the reduced number of lamps and minimal use of energy.

Optimum flow in the reactors is based on intensive computer simulations. The radiation dose is even without over- or under-metering a partial volumetric flow. At the same time the pressure loss is kept minimal.

Your benefits

- Unique dynamic lamp heating adjusts the lamp output in seconds and provides for optimum disinfection even with rapidly varying flows and water temperatures
- Homogeneous UV dose, thanks to optimised flow behaviour in the reactor, guarantees maximum flow output with a minimum number of lamps and minimum pressure loss
- Reduced life cycle costs: Use of long service life Vario-Flux high output lamps with low energy consumption and high UV output
- Excellent flexibility: vertical or horizontal installation and free choice of flange position
- Control cabinet with efficient recirculation cooling ensures the long life of electronic components and protects against corrosion in aggressive ambient conditions
- Location-independent system monitoring in real time via the DULCOnneX platform: Improved process reliability. Reliability and transparency due to real-time monitoring, individual alarms and automated reports.
- User-friendly and intuitive: The control for the display of operating statuses and adjustment of operating parameters
- Precise documentation: all relevant operating data and events are saved on the SD card and can simply and conveniently be visualised with an analysis programme
- Access from everywhere: Simple remote monitoring and remote control by means of web-based access via LAN/Wi-Fi interface

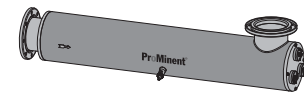

P_PMA_DS_0031_SW

Technical Details

- High-grade stainless steel 1.4404/AISI316L reactor hydraulically optimised by means of computer simulation
- High-output amalgam lamp "Vario-Flux" with dynamic lamp heating
- Guaranteed lamp service life of 14,000 operating hours (pro rata)
- Electronic ballasts for the gentle ignition, operation and individual monitoring and control of the lamps
- DVGW/ÖVGW UVC sensor 160° opening angle, highly selective and age-stable, integrated in the measuring window
- Continuous monitoring of the reactor temperature by temperature sensor Pt 1000
- Single lamp system: equipped with either a Compact controller or Comfort controller
- Various options for simple integration of the system in higher-level control systems thanks to many analogue and digital interfaces and connectors
- Data logger: all relevant operating data and all events are saved on the SD card and can simply and conveniently be visualised with an analysis programme
- Web server module enables simple remote monitoring and remote control of the system by means of web-based access via LAN/Wi-Fi interface. The current system status can be displayed at any time on a terminal unit.

Field of application

- Potable water treatment
- Food and beverage production

Options and features available

The certified Dulcodes LP systems are available in the following versions:



1 Disinfection Systems and Oxidation Systems

Type	Compact controller	Comfort controller	Systems control	Wiper	Stainless steel control cabinet	Control cabinet air-conditioning	UL/CSA compliant
Dulcodes 1x80 LP	Yes	No	No	No	No	No	No
Dulcodes 1x230 LP	Yes	Yes	Yes	No	Yes	Yes	Yes
Dulcodes 1x350 LP	Yes	Yes	Yes	No	Yes	Yes	Yes
Dulcodes 2x350 LP	No	Yes	Yes	No	Yes	Yes	Yes
Dulcodes 3x230 LP	No	Yes	Yes	No	Yes	Yes	Yes
Dulcodes 3x350 LP	No	Yes	Yes	No	Yes	Yes	Yes
Dulcodes 4x350 LP	No	Yes	Yes	No	Yes	No	Yes
Dulcodes 6x350 LP	No	Yes	Yes	No	Yes	No	Yes

Technical Data

Type	Max. flow m ³ /h	Lamp power W	Connected load W	Reactor length mm	Minimum clearance for service mm	Ø mm	Connection nominal diameter DIN / ANSI
Dulcodes 1x80LP	6.4*	81	110	872	973	140	RP 2" / RP 2"
Dulcodes 1x230LP	20.7*	260	310	1,151	1,064	140	DN 80 / 3"
Dulcodes 1x350LP	40.3*	370	430	1,640	1,465	168	DN 100 / 4"
Dulcodes 2x350LP	113*	2x370	835	1,640	1,465	256	DN 150 / 6"
Dulcodes 3x230LP	86*	3x260	825	1,185	1,156	324	DN 150 / 6"
Dulcodes 3x350LP	189*	3x370	1,240	1,885	1,565	324	DN 200 / 8"
Dulcodes 4x350LP	259*	4x370	1,645	1,885	1,565	356	DN 200 / 8"
Dulcodes 6x350LP	410*	6x370	2,455	1,885	1,565	406	DN 250 / 10"

** 98 %/cm transmission; flows certified to DVGW W 294 / ÖNORM / SVGW / ACS

Lamp type	Low-pressure lamp Vario Flux
Controller type	Comfort controller, optionally compact controller
Permissible operating pressure	10 bar or 16 bar
Permissible ambient temperature	5–40°C with comfort control, 5–35°C with compact control
Permissible water temperature	2 – 70 °C
Enclosure rating	IP 66

Low-pressure lamp Vario Flux (see page → 1-2)

Spare Parts For Dulcodes LP UV Systems

	Order no.
UV lamp Vario Flux 80 W	1061751
UV lamp Vario Flux 230 W	1061752
UV lamp Vario Flux 350 W	1061418
Lamp protection tube for Dulcodes 1x80LP	1059182
Lamp protection tube for Dulcodes 1x230LP	1058838
Lamp protection tube for Dulcodes 1x350 and 2x350LP	1049344
Lamp protection tube for Dulcodes 3 – 6x350LP	1049350
O-ring lamp protection tube/lamp cover for 1x80LP	1004920
O-ring lamp protection tube for 1x230 to 6x350LP	1023569
UVC sensor	1075544
Screwed plug G 1/2" for Dulcodes 2 – 6x350LP	1005818
Screwed plug G 1/4" for Dulcodes 1x80 to 1x350LP	1002752
O-ring for G 1/4" screwed plug for Dulcodes 1x80 to 1x350LP	1001356
O-ring for G 1/2" screwed plug for Dulcodes 2 – 6x350LP	1002279

1 Disinfection Systems and Oxidation Systems

1.1.6

UV System Dulcodes LP F&B

Chemical-free disinfection of production water for the food and beverage industry

Flow up to 189 m³/h

UV system with hygienic design of radiation chamber. For reliable disinfection and constant quality in your production process.



Pioneering water treatment – highly efficient UV system Dulcodes LP F&B with Vario-Flux lamp and dynamic lamp heating. The reduced number of lamps and minimal use of energy deliver maximum efficiency and minimal operating costs.

Optimised flow in the radiation chamber results in an even dose of radiation across the entire volumetric flow. At the same time the pressure loss is kept minimal.

The Dulcodes LP F&B is the first UV system to be quickly and precisely controllable over a wide temperature range. It automatically adapts to changing flows or changes of water temperature.

Your benefits

- Efficient, safe and chemical-free disinfection of product water in the food and beverage industry
- Hygienic design without gaps and dead space, tri-clamp connectors, surface roughness Ra <0.8 internal and external, FDA-compliant materials
- Adapted disinfection with varying flows and water temperatures
- Increased flow output with a minimum number of lamps and minimum pressure loss
- Reduced operating costs due to the long service life of Vario-Flux high-output lamps with low energy consumption and high UV output
- Location-independent system monitoring in real time via the DULCOnneX platform: Improved process reliability. Reliability and transparency due to real-time monitoring, individual alarms and automated reports.
- User-friendly and intuitive control for the display of operating statuses and adjustment of operating parameters
- Excellent flexibility, thanks to vertical or horizontal installation and free choice of the flange position
- End-to-end documentation: all relevant operating data and events are saved on the SD card and can be simply and conveniently visualised with an analysis programme
- Access from everywhere: Simple remote monitoring and remote control by means of web-based access via LAN/Wi-Fi interface

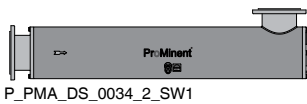

P_PMA_DS_0034_2_SW1

Technical Details

- Comprehensively certified to internationally recognised DVGW / ÖNORM / SVGW / ACS / EPA-UVDGM standards.
- The unique combination of electronic ballast technology and the Vario-Flux lamps enables the system to be quickly and precisely dimmed over a broad capacity range of up to 50%.
- Stainless steel control cabinet with degree of protection IP 66.
- Suitable for integration into CIP (cleaning in place) circuits.
- High-grade stainless steel 1.4404/AISI316L reactor hydraulically optimised by means of computer simulation.
- High-output amalgam lamp "Vario-Flux" with dynamic lamp heating.
- Guaranteed lamp service life of 14,000 operating hours (pro rata).
- Electronic ballasts for the gentle ignition, operation and individual monitoring and control of the lamps.
- DVGW/ÖVGW UVC sensor 160° opening angle, highly selective and age-stable, integrated in the measuring window.
- Various options for simple integration of the system in higher-level control systems thanks to many analogue and digital interfaces and connectors
- Data logger: all relevant operating data and all events are saved on the SD card and can be simply and conveniently visualised with an analysis programme.
- Web server module enables simple remote monitoring and remote control of the system by means of web-based access via LAN/Wi-Fi interface. The current system status can be displayed at any time on a terminal unit.

Field of application

- Food and beverage production



1 Disinfection Systems and Oxidation Systems

Technical Data

Type	Max. flow m ³ /h	Lamp power W	Connected load W	Reactor length mm	Minimum clearance for service mm	Ø mm	Tri-Clamp connector width DIN / ANSI
Dulcodes 1x350LP	40.3*	370	430	1,640	1,465	168	DN 100
Dulcodes 2x350LP	113*	2x370	835	1,640	1,465	256	DN 150
Dulcodes 3x350LP	189*	3x370	1,240	1,885	1,565	324	DN 200

** 98 %/cm transmission; flows certified to DVGW W 294 / ÖNORM / SVGW / ACS

Lamp type	Low-pressure lamp Vario Flux
Controller type	Comfort controller
Permissible operating pressure	10 bar
Permissible ambient temperature	5
Max. ambient temperature	40
Permissible water temperature	2 – 70 °C
Enclosure rating	IP 66

Low-pressure lamp Vario Flux (see page → 1-2)



1 Disinfection Systems and Oxidation Systems

1.1.7

UV System Dulcodes LP-PE Plastic

Chemical-free and reliable disinfection of water containing salt, such as sea water or thermal water.

Flow up to 505 m³/h

Disinfection of saline sea water or thermal water with corrosion resistant reactor the UV system Dulcodes LP-PE. The UV system consists of a reactor and a UV sensor made of highly UV-resistant plastic.



The UV system Dulcodes LP-PE plastic is absolutely corrosion-free. This is ensured by the UV-stabilised, highly compressed HD-PE reactor and a special sensor made of plastic. The reactor is temperature-resistant through a special welding process and optimised to a pressure rating of up to 4 bar. Our patented Vario-Flux high-output lamps with dynamic lamp heating are used in our LP-PE systems. We achieve an extremely high UVC efficiency, thanks to the unique combination of electronic ballast technology and the Vario Flux lamps.

Your benefits

- Reactor made of UV-stabilised high-density HD-PE, absolutely corrosion-free and temperature stable.
- Durable, salt water-resistant UVC sensor for monitoring the disinfection capacity, contamination of the lamp protection tubes, lamp ageing and water transmission.
- Highly efficient Vario Flux 350 W lamps provide for maximum disinfection and flow rate with a minimum number of lamps.
- Electronic ballasts for the gentle ignition, and monitoring of operation and individual lamps.
- The replacement of lamps is reduced to the absolute minimum.
- Location-independent system monitoring in real time via the DULCOneX platform: Improved process reliability. Reliability and transparency due to real-time monitoring, individual alarms and automated reports.
- Low maintenance costs and low follow-on costs, as there are fewer, high-performance lamps featuring amalgam technology with an excellent service life of up to 14,000 hours.
- Excellent flexibility thanks to vertical or horizontal installation.
- Data logger: all relevant operating data and events are saved on the SD card and can be simply and conveniently visualised with an analysis programme.
- Simple remote monitoring and remote control of the system by means of web-based access via LAN/Wi-Fi interface.

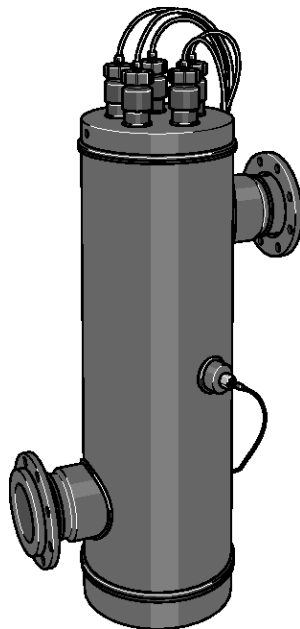

pk_7_047

Technical Details

- Reactor made of UV-stabilised high-density HD-PE
- High-performance and highly efficient low-pressure amalgam lamps Vario Flux with dynamic lamp heating
- Guaranteed (pro rata) lamp service life: 14,000 hours of operation
- Long-term stable UVC sensor, made of PTFE, for continuous monitoring of the system, factory-calibrated in accordance with the DVGW standard.
- Control cabinet made of coated steel
- Single lamp system: equipped with either a Compact controller or Comfort controller UVCb
- Various options for simple integration of the system in higher-level control systems thanks to many analogue and digital interfaces and connectors
- Data logger: all relevant operating data and all events are saved on the SD card and can be simply and conveniently visualised with an analysis programme.
- Web server module enables simple remote monitoring and remote control of the system by means of web-based access via LAN/Wi-Fi interface. The current system status can be displayed at any time on a terminal unit.

Field of application

- Process water
- Swimming pool water
- Salt water



1 Disinfection Systems and Oxidation Systems

Technical Data

Type	Max. flow m ³ /h	Lamp power W	Connected load W	Reactor length mm	Minimum clearance for service mm	Ø mm	Connection nominal diameter DIN / ANSI
1x350LP-PE	35*	1x380	430	1,590	1,565	140	DN 80
2x350LP-PE	123*	2x380	835	1,590	1,565	280	DN 125
3x350LP-PE	252*	3x380	1,240	1,590	1,565	400	DN 200
4x350LP-PE	328*	4x380	1,645	1,590	1,565	400	DN 200
6x350LP-PE**	505*	6x380	2,455	1,590	1,565	500	DN 300

* 98%/cm transmission; 400 J/m² radiation intensity

** permissible operating pressure 3 bar

Lamp type	Low-pressure lamp Vario Flux
Controller type	Comfort controller, optionally compact controller
Permissible operating pressure	4 bar
Ambient temperature	5–40°C with comfort control, 5–35°C with compact control
Permissible water temperature	5 – 30 °C
Enclosure rating	IP 66

Low-pressure lamp Vario Flux (see page → 1-2)

Spare parts for Dulcodes LPPE UV systems

	Order no.
UV lamp Vario Flux 350 W	1061418
Lamp protection tube for Dulcodes LP PE systems	1026694
O-ring lamp protection tube for 1x230 to 6x350LP	1023569
O-ring lamp cover	1006332
O-ring sensor K, PTFE	1035201
O-ring for UVC sensor K, PTFE	1041049

1 Disinfection Systems and Oxidation Systems

1.1.8

UV System Dulcodes MP

Effective solution for the treatment of swimming pool water – designed for the decomposition of combined chlorine.

Flow up to 853 m³/h



The UV system Dulcodes MP is used for the efficient breakdown of combined chlorine in swimming pools, eliminating the typical swimming pool odour: no more irritation for eyes, nose and skin. Apart from improving the water quality, the lower investment costs and high fresh water and energy consumption savings result in shorter payback times.

The UV system Dulcodes MP is fitted with output-optimised medium-pressure lamps, which guarantee the efficient photochemical breakdown of combined chlorine in swimming pool water. The system is insensitive to the most adverse conditions in warm, humid plant rooms enriched by aggressive chemicals. The robust system technology remains completely unaffected by this.

Efficient cleaning of the lamp protection tubes during operation is possible with ease. The lamp protection tubes can either be cleaned by a manual wiper or by the optionally extendible motor-driven automatic wiper.

The Dulcodes MP is a compact inline system. Thanks to its flexible flange options, the system can be used with ease for different nominal widths of circulation rate. The UV reactor is designed in such a way that no UV radiation can escape from the reactor. This means that the system can be installed directly in a plastic pipe. The free choice of the fitting position simplifies installation and retrofitting in the extreme.

Your benefits

- Simple installation, thanks to the compact inline system, ensures minimum installation costs and fast retrofitting.
- Maximum flexibility when installing, thanks to free choice of the fitting position and direct installation in plastic pipes, as no UV radiation escapes from the reactor.
- Automatic switching on and off based on the chloramine value, for example in conjunction with the DULCOMARIN®.
- Unbeatably simple and quick maintenance: All maintenance work can be carried out quickly and conveniently from one side.
- Manual power control for optimum adaptation of the system to the respective capacity requirement (not for Dulcodes 1 x 0.65MP and 1MP).
- Manual or automatic wiper system for the efficient removal of deposits on the lamp protection tube. The wiper system can be easily retrofitted.

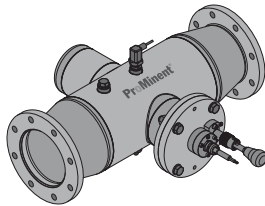

P_PMA_DS_0032_SW

Technical Details

- Integral temperature switch to monitor the water temperature in the radiation chamber.
- Compliance with DIN 19643 and recommended for use in swimming pools.
- Optimised use of energy, thanks to large radiation chamber and uniform irradiation of the entire water flow due to optimised system hydraulics.
- Radiation chambers made of high-grade stainless steel 1.4404/AISI316L.
- Long-term stable UVC sensor for monitoring the lamp output, dirt on the lamp protection tube and changes in water quality.
- Powerline medium-pressure lamps with high connecting power of up to 3 kW.
- Manual or automatic motor-driven wiper for the efficient removal of deposits on the lamp protection tube.
- Guaranteed (pro rata) lamp service life of 8,000 hours.
- Comfort controller with various options for simple integration of the plant in higher-level control systems, thanks to many analogue and digital interfaces and connectors.
- Control cabinet made of painted steel.

Field of application

- Process water
- Swimming pool water



1 Disinfection Systems and Oxidation Systems

Technical Data

Type	Max. flow m ³ /h	Lamp power W	Connected load kW	Reactor length mm	Minimum clearance for service mm	Empty weight/ Operating weight kg	DIN connector DIN / ANSI
1x0,65MP	20.0* / 30**	650	0.75	500	335	21/31	DN 65/80
1x1MP	58.0* / 87**	1000	1.10	700	400	31/47	DN 100/125
1x2MP	102.0* / 153**	2000	2.10	700	500	38/65	DN 125/150
1x3MP	205.0* / 308**	3000	3.20	800	600	52/118	DN 200/250
2x2MP	278.0* / 417**	4000	4.20	900	1,000	78/166	DN 200/250
2x3MP	379.0* / 568**	6000	6.20	900	1,000	78/166	DN 250
3x3MP	569.0* / 853**	9000	9.20	900	1,000	78/166	DN 250/300

* 98%/cm transmission; 600 J/m² irradiation intensity for the breakdown of combined chlorine

** 98%/cm transmission; 400 J/m² irradiation dose for disinfection applications

Lamp type	Medium-pressure lamp Powerline
Controller type	Comfort controller
Permissible operating pressure	6 bar
Permissible ambient temperature	5 – 40 °C
Permissible water temperature	5 – 40 °C
Enclosure rating	IP54

Medium-pressure lamp Powerline (see p. → 1-2)

Spare parts for Dulcodes MP UV systems

	Order no.
Powerline UV lamp 1 kW	1035179
Powerline UV lamp 2 kW	1035057
UV lamp Powerline 3 kW	1035180
Lamp protection tube for Dulcodes 1 A and 0.6 MP	1035218
Lamp protection tube for Dulcodes 1 MP	1035166
Lamp protection tube for Dulcodes 2 MP	1035041
Lamp protection tube for Dulcodes 1 x 3 MP, 2 x 2 MP, 2 x 3 MP, 3 x 3 MP	1035193
Wiper element	1027879
Spare parts kit UV MP 1 – 3 kW motor wiper	1037735
Spare parts kit UV MP 2x2 kW and 2x3 kW motor wiper	1044862
Spare parts kit UV MP 3x3 kW motor wiper	1044863
O-ring lamp protection tube/lamp cover	790410
UVC-U sensor	1080715
Sensor connection cable, 5 m long for systems supplied since September 2006	1021041
Replacement filter mats for control cabinet ventilation (2 off required per control cabinet)	1004212

1 Disinfection Systems and Oxidation Systems

1.1.9

UV System Dulcodes A

Perfect for the treatment of higher flows.

Flow up to 809 m³/h



The UV system Dulcodes A helps to ensure water quality. The UV system works energy-efficiently and cleanly based on continuously variable medium pressure lamps and can therefore automatically compensate for variations in the water quality or level of contamination.

The UV system Dulcodes A has a compact design. Output-optimised medium pressure lamps ensure effective disinfection of potable water and the photochemical breakdown of oxidants and/or combined chlorine.

The system is fitted with electronic ballasts, which continuously adjust the lamp output, either via an external signal, such as the flow rate, or by specification of a setpoint.

A long-term stable UVC sensor ensures that the system operates safely and reliably. The motor-driven automatic wiper efficiently cleans the lamp protection tubes and minimises maintenance work with types of water that have a tendency to form films. After comprehensive certification and biosimetric validation, the systems comply with strict internationally recognised NSF, UL, CSA and USEPA standards.

Your benefits

- Simple installation, thanks to the compact inline system, ensures minimal installation work and fast retrofitting
- Maximum flexibility with installation, thanks to the free choice of fitting position and direct installation in plastic pipes, as no UV radiation escapes from the reactor
- External power control via 0/4 - 20 mA standard signal for optimum adaptation of the system to changing operating conditions, such as flow fluctuations
- Automatic adjustment of the lamp output to a defined UV-C sensor signal with power increase to a raised, adjustable sensor signal via a digital input saves energy and extends the lamp service life.
- Unbeatably simple and quick maintenance: all maintenance work can be carried out quickly and conveniently from one side.
- Location-independent system monitoring in real time via the DULCOnneX platform: Improved process reliability. Reliability and transparency due to real-time monitoring, individual alarms and automated reports.
- Certified systems: NSF 50, CSA 22, UL508, comprehensively biosimetrically validated to UVDGM 2006

Technical Details

- Optimised use of energy, thanks to large radiation chamber and uniform irradiation of the entire water flow due to optimised system hydraulics.
- Radiation chambers made of high-grade stainless steel 1.4404/AISI316L
- Powerline A medium-pressure lamps with high power input of up to 3 kW
- Guaranteed (pro rata) lamp service life of 8,000 hours
- Long-term stable UVC sensor for monitoring the lamp output, lamp protection tube fouling and changes in water quality
- Integral temperature sensor for monitoring the water temperature in the radiation chamber
- Automatic motor-driven wiper for efficient removal of deposits on the lamp protection tube
- Double, independent and automatic monitoring of the wiper function by revolution counter and limit switch
- Control cabinet made of coated steel
- Freely programmable control (Comfort controller Dulcodes A) with backlit display during normal operation (green), warning (yellow) and fault (red)
- Large graphic display to show all important operating parameters, such as the UV sensor signal, lamp power consumption, control type and operating status
- Interfaces and connectors for:
 - Stopcock and flushing valve
 - Control of the feed pump
 - Operating signal relay
 - Warning and alarm relay for UV intensity
 - Collective malfunction alert relay
 - Pause contact
 - Relay for monitoring reactor temperature
 - Temperature monitoring and fault indicating relay for control cabinet temperature
 - Input for external fault
 - Digital input for switch-over to second power stage
 - 4-20 mA standard signal input for flow-dependent lamp control or control dependent on measured value
 - Standard signal output 4-20 mA of UV sensor signal

NSF 50
UVDGM 2006
UL-CSA

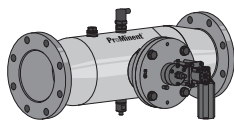

P_PMA_DS_0033_SW



1 Disinfection Systems and Oxidation Systems

Field of application

- Potable water
- Process water
- Swimming pool water

Technical Data

Type	Max. flow m ³ /h	Lamp power W	Connected load kW	Reactor length mm	Minimum clearance for service mm	Min. distance from wall mm	Empty weight/ Operating weight kg	Connector width DIN/ANSI DIN / ANSI
1 x 1A	50.0* / 83.0**	1.000	1.10	700	400	300	31/47	DN 100/4"
1 x 2A	91.0* / 149.0**	2.000	2.10	700	500	300	38/65	DN 150/6"
1 x 3A	176.0* / 290.0**	3.000	3.20	800	600	300	52/118	DN 200/8"
2 x 2A	240.0* / 395.0**	4.000	4.20	900	1,000	300	78/166	DN 200/8"
2 x 3A	328.0* / 539.0**	6.000	6.20	900	1,000	300	78/166	DN 250/10"
3 x 3A	492.0* / 809.0**	9.000	9.20	900	1,000	300	78/166	DN 300/12"

* 98 %/cm transmission; 600 J/m² UV dose for the breaking down of combined chlorine

** 98 %/cm transmission; 400 J/m² UV dose for disinfection applications

Lamp type	Medium-pressure lamp Powerline A
Permissible operating pressure	10 bar (for systems 1 x 1A - 1 x 3A) 7 bar (for systems 2 x 2A - 3 x 3A)
Permissible ambient temperature	5 – 40 °C
Permissible water temperature	5 – 40 °C
Enclosure rating	IP54

Medium-pressure lamp Powerline A (see page → 1-2)

Accessories for Dulcodes 1 x 1 A, 1 x 2 A and 1 x 3 A

	Order no.
Cable set 25 m including lamp cable, UV sensor, Pt1000, limit switch and safety switch	1106743

Spare Parts for Dulcodes A UV Systems

	Order no.
Powerline UV lamp 1 kW	1035179
Powerline UV lamp 2 kW	1041450
Powerline UV lamp 3 kW	1041451
Lamp protection tube for Dulcodes 1 A and 0.6 MP	1035218
Lamp protection tube for Dulcodes 2 A	1041723
Lamp protection tube for Dulcodes 3 A	1041485
Wiper element	1027879
Spare parts set for UV A 1-3 kW motor wiper	1042860
Spare parts kit UV MP 2x2 kW and 2x3 kW motor wiper	1044862
Spare parts kit UV MP 3x3 kW motor wiper	1044863
O-ring lamp protection tube	1023569
UVC-U sensor M -1, 4-20 mA	1080714
Replacement filter mats for control cabinet ventilation (2 off required per control cabinet)	1004212



1 Disinfection Systems and Oxidation Systems

1.1.10 Accessories for Dulcodes UV Systems



P_AC_0274_SW

Remote monitoring module UVCb web server

Module for connection to the CAN interface of the UVCb comfort control for remote monitoring and remote control of the Dulcodes systems. The module can communicate with many smart devices (smartphone, tablet) or desktop computer (PC, laptop) via Wi-Fi or LAN. The data is provided via a web server of the module and displayed on the terminal unit using any common browser. Supply including connecting cable for wall installation beside the UV system. CAN connecting cables with a length of up to 20 m enable the module to be installed at a remote distance from the UV system. The module for Dulcodes LP systems is ordered by the corresponding selection of the identity code characteristic or as a retrofit kit.

Retrofit kit

	Order no.
Web server module for Dulcodes LP	1079181
Web server module for Dulcodes MP	1082107

Available connection cable

	Order no.
Connecting cable LAN M12 - RJ45 5.0 m	1026715
Connecting cable CAN, 20 m	1079095
EMC earthing clamp	1051489

1/2" drain kit for Dulcodes LP systems

2 no. 1/2" stainless steel ball valves and connecting material for direct connection to the reactor for drainage and bleeding.

	Order no.
1/2" drain kit for Dulcodes 3 x 350LP to 6 x 350LP	1075776

Transmission Photometer UVT P200

Photometer for measuring 254 nm UV transmission.

Supplied in stable, compact, water-tight plastic box including 10 mm quartz cuvette. Storage of the in-situ calibration means that a calibration using deionised water prior to every calibration is not necessary.

Dimensions L x W x H (mm)	230 x 190 x 95
Weight	1.8 kg
Voltage supply	100 - 240 V AC 50/60 Hz, 12 V DC auto-adapter
UV-C lamp	Mercury medium pressure lamp
Measuring resolution	Transmission in 0.1%
Measuring accuracy	Transmission in ± 0.5%
Measuring range	5 – 100%/cm

	Order no.
Transmission Photometer UVT P200	1045245



1 Disinfection Systems and Oxidation Systems

Reference Radiometer RRM

Reference radiometer for checking certified UV systems Dulcodes LP. The portable instrument is fitted with an insertion sensor which is used for measurement of the radiation intensity without operational interruption directly in the radiation chamber of the Dulcodes LP in place of the unit sensor. Suitable UV protective glasses should be worn as UV radiation escapes from the radiation chamber during this procedure.

Measuring range	20/200/2,000/20,000 W/m ² (switchable)
Display	3-digit
Voltage supply	Battery, 9 V Type 6F22 or equivalent

		Order no.
Reference radiometer RRM	for measuring field angle 40°	1025094
Reference radiometer RRM	for measuring field angle 160°	1076575
Reference radiometer RRM	for measuring field angle 40° and 160°	1076576

UV Protective Glasses

Protective glasses to protect against UV radiation that can be harmful to the eyes when working on open UV systems.

	Order no.
UV protective glasses	1025243

Protective Gloves

Protective gloves made of white cotton to avoid fingerprints on UV lamps and lamp sleeves. 1 pair universal size.

	Order no.
Protective gloves	1032815

Sampling Cock

Fireproof sampling cock made of stainless steel.

	Order no.
Sampling cock	On request

Cleaning System

Cleaning system for flushing the radiation chamber with a cleaning solution to remove deposits on the lamp tubes and internal surfaces of the UV system. Consists of chemical tanks, booster and metering pumps, valves and complete automatic or manual controller. Design and technical equipment are matched to the particular UV system and its application.

	Order no.
Cleaning system	On request



1 Disinfection Systems and Oxidation Systems

Fittings

Fittings provided for quick and easy wall mounting of the UV radiation chamber. Fitting parts comprise 2 screw-in pipe clips in high alloy steel (V2A), 2 base plates with M12 nut, 2 set screws and 4 M12 hexagon nuts.

Two-part clip with increased material cross-section to ensure high bearing strength and breaking resistance. A soundproofing layer ensures marked resistance in the sound level.

	Type	Order no.
Fittings A2	1x80LP, 1x230LP	1039828
	1x350LP, 3x230LP	1077823
	2x350LP	1077844

Overvoltage Protection

Overvoltage protection for Dulcodes UV systems operated at 230 V 50-60 Hz.

The external overvoltage protection is intended for operations when the device's internal protection is not sufficient for surge voltages of 1 kV between the conductors and 2 kV to earth. An overvoltage trip can be fitted as a low protection surge arrester to significantly increase the stability of the Dulcodes systems to protect them when the supply mains is prone to disturbance energy.

It can only be determined by thorough investigation of the voltage behaviour on site whether the low protection surge arrester requires further measures, such as medium and main protection.

	Order no.
Fine protection PT 2-DE IS 230 IAC	733010

Replacement Plug-in Insert After Tripping

	Order no.
Replacement plug-in insert PT 2-DE / S 230 / AC - ST	733011

Clip-on thermostat for systems with compact control

	Order no.
Clip-on thermostat 30-90 °C 230 VAC	1043944



1 Disinfection Systems and Oxidation Systems

1.1.11

DULCOneX – digital fluid management



Location-independent system monitoring in real time

You always have all the key data and measured values in sight at all times with DULCOneX. Monitor and document the status of your system in real time. Check your unit data, regardless of where you are, safely and reliably when you're out and about. Simply use the terminal device of your choice: smartphone, tablet or PC.

Refer to our catalogue or website for more information and references.



1 Disinfection Systems and Oxidation Systems

1.2 Ozone Systems OZONFILT®

1.2.1 Ozone in Water Treatment

As the most powerful oxidant that can be used in water treatment, ozone permits a broad spectrum of possible applications:

Outstanding disinfection action against

- Bacteria and viruses
- Fungi and parasites

Oxidation of undesirable inorganic substances in the water

- Iron and manganese
- Arsenic
- Nitrite and sulphide

Oxidation of undesirable organic substances in the water

- Strong-smelling and strong-tasting compounds
- Humic substances and other compounds which affect the colour of the water
- Cyclic hydrocarbons
- Trihalomethanes, chloramines and other chlorine compounds

Micro-flocculating properties

- After oxidation with ozone, substances and colloids dissolved in the water become insoluble and can be filtered

Significantly less environmentally harmful by-products result from the generation and use of ozone than other comparable oxidants and disinfectants. As a highly reactive gas, ozone is generated on site from oxygen, and introduced to the water directly, without interim storage. Because of its high reactivity, ozone decomposes into oxygen again in the water, with a half-life of several minutes. Therefore all components of an ozone handling system have to be perfectly coordinated to each other and the planned application, to achieve an optimum relationship between ozone generation and its effect.

With every new project, our engineers draw on experience that we have accumulated since 1971 in the following applications:

Potable water supply

- Oxidation of iron, manganese or arsenic
- Refinement and improvement of taste
- Disinfection

Food and beverage industry

- Disinfection of table water
- Disinfection of rinsers in the beverage industry
- Disinfection of process water

Swimming pools

- Reduction of chloramines and trihalomethanes, avoiding typical swimming pool odours
- Crystal clear water, thanks to micro-flocculating action
- Reliable microbiological barriers in therapy pools
- Reduction of investment and operating costs by the possibility of reducing the circulating power and throttling the fresh water inlet

Industry

- Cooling water treatment
- Combating legionella in cooling water circuits
- Disinfection of process water
- Removal of odorous substances in air scrubbers

Municipal waste water treatment

- Breakdown of trace substances
- Reduction of clarifier sludge
- COD reduction/breakdown
- Removal of colouring



1 Disinfection Systems and Oxidation Systems

1.2.2 Performance Overview of Ozone Systems

ProMinent® ozone systems work on the proven principle of silent electrical discharge. Ozone is produced from oxygen between two electrodes separated by an insulating dielectric by applying a high voltage of several thousands of volts. Depending on the system type, either dried ambient air or concentrated oxygen is used as the source of oxygen. ProMinent® ozone systems are optimised to ensure maximum return and operating safety. They conform to the German DIN 19627 standard for ozone generation systems and are characterised by low energy and cooling water consumption.

Medium-frequency pressure systems

With the OZONFILT® OZVb and OZMa product range, the air or oxygen operating gas is fed to the ozone generator under pressure. Ozone is generated using medium-frequency high voltage.

The use of an integrated pressure swing dryer and a dielectric with optimum thermal conductivity makes the system extremely compact.

Operation under pressure means that the ozone generated can be introduced directly into water systems up to a back pressure of 4 bar with OZVb and up to 2 bar with OZMa. Additional booster pumps and injectors can therefore be dispensed with in many applications.

ProMinent offers a wide range of ozone systems for the most diverse applications. The following overview shows the capacity ranges of our type series:

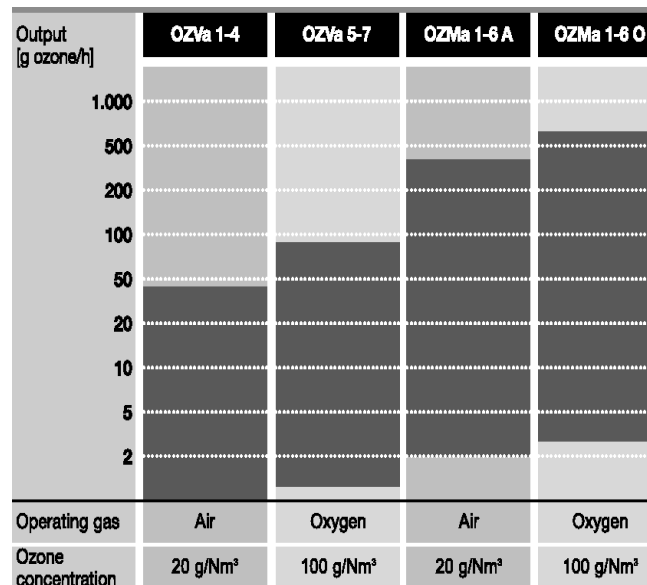

P_PMA_OF_0091_C

larger systems available on request

ProMinent provides all the advice needed for the safe operation of an ozone system:

- Evaluation of the situation on site by trained, expert field sales staff.
- We can measure all key water parameters required for optimum system design in our water laboratory.
- Project planning of the system.
- Commissioning and system maintenance by our trained service technicians.



1 Disinfection Systems and Oxidation Systems

1.2.4

Ozone system OZONFILT® OZVb

Powerful and environmentally-friendly disinfection and oxidation

Ozone capacity 10 – 70 g ozone/h

OZONFILT® OZVb is powerful and compact and is ideal for efficient ozone generation from compressed air in the output range of up to 70 g/h. The turnkey ozone system including mixing equipment offers everything you need for safe and seamless operation.

Ozone systems OZONFILT® OZVb are pressurised systems in which compressed air is fed into the ozone generator.

Ozone is generated from the oxygen content of the surrounding air, via a compressor and is inducted into the process based on demand. Ozone can now be generated in values of up to 20 g/Nm³, safely and reliably in the many demanding environments and plant room locations globally. Ozone concentrations within the water to be treated with values of between 3 and 12 ppm can be achieved using our coordinated mixing equipment with an efficiency of up to 95%.

Your benefits

- Safe and seamless operation through continuous monitoring of all relevant operating data
- Simple, safe and reliable operation with process visualisation, thanks to a large, coloured and clearly arranged 4.3" touch panel
- Compact system with integral air treatment
- Turnkey complete system with perfectly coordinated mixing device including back pressure valve, vacuum breaker and static mixer
- Direct injection without injector system for up to 4 bar back pressure
- Location-independent system monitoring in real time via the DULCOnneX platform: Improved process reliability. Reliability and transparency due to real-time monitoring, individual alarms and automated reports.
- Low maintenance and operating costs, thanks to maintenance-free generator concept and virtually infinite service life
- Maximum efficiency with minimal consumption of energy and cooling water
- Continuously variable and precise output control between 3% and 100% of the nominal power with display of the ozone volume in "grammes/hour"
- Automatic adjustment of the performance data to fluctuations of mains voltage and pressure



Technical Details

- 4 different sizes depending on the capacity range
- Compact mounting in a painted steel cabinet
- Special dielectric with outstanding cooling performance: in spite of the low cooling water consumption, heat is quickly and efficiently discharged before the ozone produced can decompose due to excessive heat
- Integrated air treatment based on a pressure swing dryer with adjustable throttle valve and analogue flow measurement and pressure monitoring
- Continuous analogue pressure measurement in the ozone generator with automatic capacity adjustment to compensate for pressure fluctuations
- Cooling water system with automatic shut-off valve, adjustment valve and monitoring device via flow and temperature sensor
- Gas-tight diaphragm valve at the ozone outlet
- PLC (Programmable Logic Controller) control with operating data recorded on an SD card
- Simple, safe and reliable operation with process visualisation, thanks to large, colour and clear 4.3" touch panel
- Contact inputs for external On/Off switching, gas detector connector, external fault alert, flow control
- Analogue input 4-20 mA for power control depending on the measured value combined with external measuring and control technology
- Contact outputs for collective malfunction alert, warning and operation
- Wide range of communication interfaces for connection to higher-level controls or for remote monitoring (LAN web server, PROFIBUS® DP, PROFINET®, Modbus TCP or RTU)
- Evaluation and analysis program for the simple and fast visualisation of operating data on a PC

Options

- Stainless steel control cabinet
- Pressure controller with filter unit at the compressed air input
- Different designs of ready-wired installed mixing unit up to complete equipment including back pressure valve, vacuum breaker and integral static mixer
- Air conditioning: The system can be equipped with integral air conditioning with ambient temperatures above 40 °C
- Control of a cooling water heat exchanger
- Integration of a dew point sensor to monitor the quality of compressed air

1 Disinfection Systems and Oxidation Systems

Field of application

- **Potable water supply:** Oxidation of iron, manganese and arsenic, refinement and taste enhancement and disinfection
- **Waste water treatment:** Degradation / reduction of COD and micro-contaminants, reduction of sewage sludge
- **Food and beverage industry:** Oxidation of iron and manganese, disinfection of table water and rinsing water
- **Swimming pools:** Degradation of disinfection by-products, reliable microbiological barrier and production of crystal-clear water, thanks to its micro-flocculating effect
- **Industry:** Legionella prevention and disinfection of cooling water



1 Disinfection Systems and Oxidation Systems

OZONFILT® ozone generation systems OZVb 1 – 4 (operating gas air)

Technical Data

Ambient parameters

Max. 85% air humidity of the ambient air, non-condensing, non-corrosive, dust-free, max. ambient temperature: 40 °C (with integrated air conditioning system: 50 °C)

		OZVb 1	OZVb 2	OZVb 3	OZVb 4
Number of generator modules		1	1	1	2
Nominal ozone capacity, measured according to DIN standards for air: 20 °C, Cooling water: 15 °C, 0.8-2 bar	g/h	10	20	35	70
Ozone output max. 2.5 bar	g/h	8.0	16.0	28.0	56.0
Ozone output max. 3.0 bar	g/h	6.2	12.4	21.7	43.4
Ozone output max. 3.5 bar	g/h	4.4	8.8	15.4	30.8
Air consumption (only ozone generation)	Nm ³ /h	0.50	1.00	1.75	3.50
Ozone concentration in the gas phase based on standard conditions and nominal power	g/Nm ³ *	20	20	20	20
Specific energy requirement at nominal capacity	Wh/g	16.5	16.5	16.5	16.5

* Nm³ = m³ under normal [standard] conditions (p = 1.013x10⁵ Pa, T = 273 K)

Electrical Connection

		OZVb 1	OZVb 2	OZVb 3	OZVb 4
Connected load	V/Hz/A	230/50;60/2	230/50;60/6	230/50;60/6	230/50;60/10
Enclosure rating		IP 54	IP 54	IP 54	IP 54
Degree of protection with integrated air conditioning unit (internal/external)		IP 54 / IP 34	IP 54 / IP 34	IP 54 / IP 34	IP 54 / IP 34

Overall Dimensions (Without Mixer)

Wall-mounted cabinet with OZVb 1, 2 and 3; floor-mounted cabinet with OZVb 4

		OZVb 1	OZVb 2	OZVb 3	OZVb 4
Width	mm	760	760	800	800
Height	mm	760	760	1,000	1,200
Depth	mm	300	300	300	300

Weight

		OZVb 1	OZVb 2	OZVb 3	OZVb 4
Weight	kg	80	80	95	140

Ozone Mixing

		OZVb 1	OZVb 2	OZVb 3	OZVb 4
Max. raw water temperature	°C	35	35	35	35
Permissible pressure at ozone outlet	bar	0.8–4.0	0.8–4.0	0.8–4.0	0.8–4.0

Air Supply

		OZVb 1	OZVb 2	OZVb 3	OZVb 4
Air demand	Nl/min	11.1	22	38	76

Air quality Oil and dust-free, non-corrosive, constant priming pressure of 4.5 – 10 bar, max. temperature 40 °C

Cooling Water

		OZVb 1	OZVb 2	OZVb 3	OZVb 4
Cooling water consumption (15 °C)	l/h	10	20	35	70
Cooling water inlet pressure	bar	1–5	1–5	1–5	1–5
Cooling water inlet		G 1/4" female	G 1/4" female	G 1/4" female	G 1/4" female
Cooling water outlet, open discharge		G 1/4" female	G 1/4" female	G 1/4" female	G 1/4" female
Cooling water temperature at ambient temp. max. 35 °C	°C	<30	<30	<30	<30
Cooling water temperature at ambient temp. 35–40 °C	°C	<25	<25	<25	<25

Cooling water quality No tendency to form lime scale, no corrosive components; substances with a tendency to sediment: < 0.1 ml/l; iron: < 0.2 mg/l; manganese: < 0.05 mg/l; conductivity: > 100 µS/cm; chloride: < 250 mg/l



1 Disinfection Systems and Oxidation Systems

Identity Code Ordering System for OZONFILT® OZVb systems

OZVb	Type	Air operation
		g/h
	01	10
	02	20
	03	35
	04	70
		Operating gas
	A	Air
		Design
	P	ProMinent with yellow/red master switch
	G	ProMinent with grey maintenance switch
		Cooling
	0	none
	1	Air conditioning of control cabinet
	2	Control of cooling water heat exchanger
	3	Air conditioning of control cabinet and control of cooling water heat exchanger
		Mechanical design
	0	Standard control cabinet with packaging for transport by truck
	1	Standard control cabinet with packaging for sea/air freight
	2	Stainless steel control cabinet with packaging for transport by truck
	3	Stainless steel control cabinet with packaging for sea/air freight
	4	Standard control cabinet without packaging
	5	Stainless steel cabinet without packaging
		Gas treatment
	1	Gas treatment integrated without filter package
	2	Gas treatment integrated with filter package
		Default language
	DE	German
	EN	English
	FR	French
	IT	Italian
	ES	Spanish
		Communication interfaces
	0	none
	2	Modbus TCP
	4	PROFIBUS® DP
	5	PROFINET®
		Additional options
	0	none
	1	Dewpoint sensor
	2	External water trap
	3	Back pressure valve
	4	Dewpoint sensor + external water trap
	5	Dewpoint sensor + back pressure valve
	6	External water trap + back pressure valve
	7	Dewpoint sensor + external water trap + back pressure valve
		Mixing unit for wall-mounted cabinet systems (OZVb 1-3)
	0	none
	1	with PVC static mixer, DN 32, 0.5 – 2.8 m³/h
	2	with PVC static mixer, DN 32, 2.8 – 5 m³/h
	3	with PVC static mixer, DN 40, 5 – 10 m³/h
	4	with PVC static mixer, DN 50, 10 – 15 m³/h
	5	with PVC static mixer, DN 65, 15 – 25 m³/h



1 Disinfection Systems and Oxidation Systems

1.2.5

System Solution OZONFILT® Compact OMVb

The perfect system solution for the beverage industry

Ozone capacity 20 – 70 g/h

OZONFILT® Compact OMVb is a complete, ready-to-use system solution for the generation and metering of ozone.

The ozone system OZONFILT® Compact OMVb has a modular design mounted on a stainless steel frame. A sufficient quantity and constant concentration of ozonised water is produced in the system's contact and outgassing tank. From there, it is fed back to where it is needed. The required ozone concentration has variable settings and is continuously controlled and held constant by a measuring and control circuit. Depending on the application, the ozonised water is pumped by system pressure or with one or more discharge pumps to where it is needed.

With the removal and replenishment of water in the storage tank, undissolved ozone is safely routed outside via a residual ozone gas destructor. No ozone will escape into the ambient air in normal operation.

Your benefits

- Excellent process reliability through the use of a pre-assembled, complete ozone treatment stage with perfectly coordinated components.
- Fully piped and wired system on a stainless steel frame for plug-and-play connection.
- Modular construction, yet nevertheless can be customised.
- Compression-proof ozone generator built in compliance with DIN 19627.
- Destruction of residual ozone gas for the removal of traces of ozone gas.
- Room air monitoring for traces of ozone gas via a gas detector with a sensor with long-term stability.
- Measured value-dependent ozone metering ensures a constant ozone concentration in the contact tank.
- A central electric control ensures measured value-dependent ozone metering and the control of all connected peripheral components.
- Clear and simple operation, as well as signal exchange with higher-order control systems.

Technical Details

Components:

- Central control unit
- Ozone generation
- Contact and outgassing tank
- Discharge system
- Ozone mixing unit
- Residual ozone gas destruction
- Room air monitoring

Available options:

- 1 or 2 discharge pumps for pumping ozonised water to where it is used
- Cooling water chiller for the supply of chilled water to the ozone system
- Air conditioning unit for the air conditioning of the ozone system and central control cabinet
- Storage tank cleaning with built-in spray nozzle including valve combination

(For more information on the Ozone system OZONFILT® OZVb see page → 1-26)

Ozone generation, constructed in accordance with DIN 19627

The ozone is generated by an OZONFILT® OZVb in a pressure-tight ozone generator.

Central control unit

A central control unit manages the entire process and ensures measured value-dependent ozone metering. A touch panel visualises the entire process, simplifying operation. A high-quality control for industrial applications permits varied signal exchange with higher-level management systems.

Ozone mixing unit

This module comprises an ozone metering point and a downstream mixing section made of stainless steel, with a series of static mixing elements for intensive mixing of the ozone/air mix with the water to be treated. The lines carrying the ozone and the pipework from the raw water connection to the inlet to the contact tank are made throughout in stainless steel and have been factory-pressure tested.

An injector for drawing out the ozone by suction is not needed with back pressures of up to 4 bar because the ozone is generated at positive pressure.



P_OF_0096_SW1

1 Disinfection Systems and Oxidation Systems

Contact and outgassing tank

The stainless steel tank incorporates all the necessary fittings for water distribution and ensures adequate contact time and efficient outgassing.

Discharge system

As soon as the ozone concentration setpoint has been reached, the ozonised water is pumped on-demand to where it is needed. This is done by the feed pump or a discharge system with one or more discharge pumps.

Residual ozone gas destruction

A residual ozone gas destruction unit with integral water separator is used for the safe removal of undissolved ozone gas in the exhaust air from the contact tank.

Gas detector

The room air is monitored for ozone leaks using a gas detector with electrochemical sensor. If the alarm threshold is exceeded, ozone generation is stopped and an alarm signalled. A buzzer is activated at the same time.

Field of application

- Food and beverage industry: Disinfection of table and rinsing water

Technical Data

Type TWA for filler		OMVb TWA 20 – 1000	OMVb TWA 35 – 1000	OMVb TWA 70 – 2000
Type: ozone generation system		OZVb 2	OZVb 3	OZVb 4
Volume of contact storage tank	l	1,000	1,000	2,000
Ozone output at 20 g/Nm³	g/h	20	35	70
Nominal flow rate	m ³ /h	5 – 15	15 – 30	45 – 60
Enclosure rating		IP 54	IP 54	IP 54
Type RI for rinsing applications		OMVb RI 20 – 500		
Type: ozone generation system		OZVb 2		
Volume of contact storage tank		500 l		
Ozone output at 20 g/Nm³		20 g/h		
Nominal flow rate		5 – 15 m ³ /h		
Enclosure rating		IP 54		



1 Disinfection Systems and Oxidation Systems

1.2.6 Ozone System OZONFILT® OZMa

Powerful and yet environmentally-friendly. Disinfect and oxidise ecologically and economically.

Ozone capacity 70 – 735 g ozone/h

OZONFILT® OZMa represents maximum operational safety with minimal operating costs. The ozone generator is maintenance-free and generates up to 735 g/h of ozone from compressed air or oxygen.

The ozone systems OZONFILT® OZMa have been designed as pressurised systems, in which the operating gas – air or oxygen – is fed into the ozone generator under pressure.

Air is used as the operating gas in the ozone system Ozonfilt® OZMaA types 1 to 6

The ozone is generated from the oxygen in the ambient air and simultaneously metered. A demand-led, self-optimising pressure swing dryer reduces the consumption of compressed air to a minimum. Ozone can therefore be generated operationally safely and reliably even with a high level of ambient air humidity with ozone concentrations of up to 20 g/Nm³. Ozone concentrations of between 3 and 12 ppm can be achieved in the water to be treated with suitable mixing units, depending on the temperature.

Oxygen is used as the operating gas in the ozone system Ozonfilt® OZMaO type 1 to 6

Operation with oxygen permits ozone generation with ozone concentrations of up to 150 g/Nm³. Depending on the system type, ozone is produced in 1-3 generators from oxygen provided from special oxygen generators or bottles. Using the suitable mixing equipment, ozone concentrations of up to 90 ppm can be achieved in the water to be treated, depending on the temperature.

Your benefits

- Economical: maintenance-free generator concept with virtually unlimited service life
- Up to 30% energy savings for air treatment, thanks to demand-controlled and self-optimising air drying compared to conventional air treatment.
- Automatic control of the operating gas depending on the ozone output, therefore reduced consumption of operating gas produced with intensive use of energy.
- High ozone concentration ensures optimum ozone solubility in water
- Direct injection without injector system at up to 2 bar back pressure
- Location-independent system monitoring in real time via the DULCOneX platform: Improved process reliability. Reliability and transparency due to real-time monitoring, individual alarms and automated reports.
- Automatic ozone generation, virtually independent of fluctuations in mains voltage and pressure
- Simple, safe and reliable operation as well as process visualisation, thanks to a large, coloured and clearly arranged 6.5" touch panel
- Continuous adjustment and precise output control between 3% and 100% of the nominal power with display of the ozone volume in "grammes/hour"

Technical Details

- Compact mounting, ready-to-use in a painted steel cabinet or optionally in a stainless steel cabinet
- With integrated filter package for the removal of dust and small amounts of residual oil in the compressed air
- Special dielectric with excellent cooling: In spite of the low cooling water consumption, heat is quickly and efficiently discharged before the ozone produced can decompose due to excessive heat.
- PLC with integrated ozone measurement and PID control
- 7" touch panel with data logger and screen recorder
- Multiple communication interfaces (e.g. LAN, PROFIBUS® DP)
- Excellent efficiency: Over 90% of the ozone is dissolved in the water, thanks to the special construction of the mixing unit.
- Integration of a dew point sensor to monitor the quality of compressed air
- Integration of an air conditioning unit to adjust the temperature of the ozone system
- Pause input for external switching on/off
- Contact input for locking the system, for example in the absence of flow
- Digital input for connection of a gas detector
- Digital input for control of two power stages
- 0/4-20 mA input for external output control depending on the flow or measured value with a PIC controller
- Second freely configurable 0/ 4-20 mA input
- Contact output for operating status
- Contact output for collective malfunction alert
- Contact output for limit value transgression, ozone concentration in the water too low
- One freely configurable 0/ 4-20 mA output

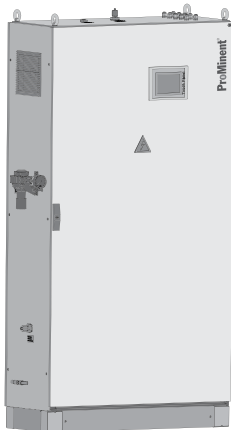

P_PMA_OF_0074_SW



1 Disinfection Systems and Oxidation Systems

Field of application

- **Potable water supply:** Oxidation of iron, manganese and arsenic, refinement and taste enhancement and disinfection
- **Waste water treatment:** Degradation/reduction of COD and microcontaminants, reduction of sewage sludge
- **Food and beverage industry:** Oxidation of iron and manganese, disinfection of potable water and rinsing water
- **Swimming pools:** Degradation of disinfection by-products, reliable microbiological barrier and production of crystal-clear water thanks to its microflocculating effect
- **Industry:** Legionella prevention and disinfection of cooling water



1 Disinfection Systems and Oxidation Systems

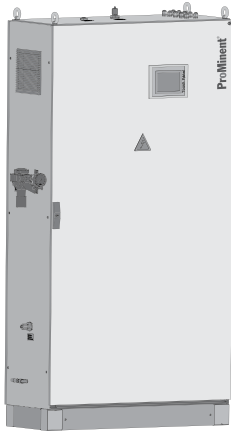

P_PMA_OF_0074_SW

Ozone Generation Systems OZONFILT® OZMa 1-6 A (Operating Gas - Air)

Under nominal conditions, the OZMa 1-6 A range produces up to 420 g/h of ozone from compressed air at a concentration of 20 g/Nm³. Using the designated mixing devices, ozone concentrations of between 3 and 12 ppm can be achieved in the water to be treated, depending on the temperature (theoretical value at 30 or 0 °C).

Different feature options can be achieved by combining different Identity code characteristics.

The plants are pre-mounted ready for connection in a painted steel cabinet (optional stainless steel control cabinet) and need only be connected to a single-phase voltage supply, compressed air, cooling water/waste water and ozone metering point on the customer's site.

An adequate compressed air supply and a mixing device designed for the operating conditions should be integrated for operation of the ozone plant.

Identity Code Ordering System for OZONFILT® OZMa Systems see p. → 1-40, Static Helical Mixer Made of PVC or Stainless Steel see p. → 1-43

Mixing equipment

All OZMa systems are delivered, in principle, without a mixing unit and a suitable mixing system has to be ordered separately. When selecting a suitable mixing system, please note that the mixing of ozone is more efficient the higher the water flow in the mixing system. Accordingly design the mixing system so that the flow of the water to be treated is at the upper range of the flow specification.

Static Helical Mixer Made of PVC or Stainless Steel see p. → 1-43

Notes on installation

Keep the length of pipes for conveying ozone and the number of joints to a minimum. Monitor all adjoining rooms with a gas detector in line with the applicable German accident prevention regulations. All OZONFILT® systems are equipped for the fitting of a gas detector, such as type Neon® Gas Ozone

Gas detector Neon® Gas Ozone See page → 1-45

Ozonisation adds a large amount of gas to the water of which only a small percentage can dissolve. Accordingly, provide for adequate bleeding. As the gases discharged in this way have a considerable residual ozone concentration, appropriate residual ozone destructors should be installed.

It is necessary for the ozone generation system to be interlocked with the water flow to the ozone metering on all installations.

Install a non-return valve between the OZMa and the ozone point of injection to prevent the return of ozonised water into the pipe that transports the ozone.

Room Air Monitoring see p. → 1-45, Residual Ozone Gas Destructor see p. → 1-44

1 Disinfection Systems and Oxidation Systems

Technical Data

Ozone Generation Systems OZONFILT® OZMa 1-3 A (Process Gas - Air)

Ambient parameters

Max. 85% air humidity of the ambient air, non-condensing, non-corrosive, dust-free, max. ambient temperature: 40 °C (with integrated air conditioning system: 50 °C)

		OZMa 1A	OZMa 2A	OZMa 3A
Number of generator modules		1	1	1
Ozone capacity, measured in accordance with DIN with air at 20 °C, cooling water at 15 °C	g/h	70	105	140
Air consumption (only ozone generation)	Nm ³ /h	3.50	5.25	7.00
Ozone concentration in the gas phase referenced to nominal conditions	g/Nm ³ *	20	20	20
Specific energy requirement at nominal capacity	Wh/g	16.5	16.5	16.5
Power factor at full capacity	cos φ	0.95	0.95	0.95
Ozone connection		Rp 3/8"	Rp 3/8"	Rp 3/8"

* Nm³= m³ at standard conditions (P = 1.013x10⁵Pa, T = 273 K)

Electrical Connection

		OZMa 1A	OZMa 2A	OZMa 3A
Connected load	V/Hz/A	230/50;60/10	230/50;60/16	230/50;60/16
Enclosure rating		IP 54	IP 54	IP 54
Degree of protection with integrated air conditioning unit (internal/external)		IP 54 / IP 34	IP 54 / IP 34	IP 54 / IP 34

Overall Dimensions (Without Mixer)

		OZMa 1A	OZMa 2A	OZMa 3A
Width	mm	1,114	1,114	1,114
Height	mm	1,961	1,961	1,961
Depth	mm	405	405	405

Weight

		OZMa 1A	OZMa 2A	OZMa 3A
Weight	kg	270	280	300

Ozone Mixing

		OZMa 1A	OZMa 2A	OZMa 3A
Max. raw water temperature	°C	35	35	35
Permissible pressure at ozone outlet	bar	0.8–2.0	0.8–2.0	0.8–2.0

Air Supply

		OZMa 1A	OZMa 2A	OZMa 3A
Air demand	NI/min	73	110	147

Air quality oil and dust-free, non-corrosive, constant priming pressure of 4.5 – 10 bar, max. temperature 40 °C

Cooling Water

		OZMa 1A	OZMa 2A	OZMa 3A
Cooling water consumption (15 °C)	l/h	90	135	180
Cooling water consumption (30 °C)	l/h	125	190	250
Cooling water inlet pressure	bar	2–5	2–5	2–5
Cooling water inlet, PE pressure hose	mm	8 x 5	8 x 5	12 x 9
Cooling water outlet, open discharge	mm	8 x 5	8 x 5	12 x 9

Cooling water quality No tendency to form lime scale, no corrosive components, removable substances: < 0.1 ml/l, iron: < 0.2 mg/l, manganese: < 0.05 mg/l, conductivity: > 100 µS/cm, chloride: < 250 mg/l



1 Disinfection Systems and Oxidation Systems

Ozone Generation Systems OZONFILT® OZMa 4-6 A (Process Gas - Air)

Ambient parameters

Max. 85% air humidity of the ambient air, non-condensing, non-corrosive, dust-free, max. ambient temperature: 40 °C (with integrated air conditioning system: 50 °C)

		OZMa 4A	OZMa 5A	OZMa 6A
Number of generator modules		2	2	3
Ozone capacity, measured in accordance with DIN with air at 20 °C, cooling water at 15 °C	g/h	210	280	420
Air consumption (only ozone generation)	Nm ³ /h	10.50	14.00	21.00
Ozone concentration in the gas phase referenced to nominal conditions	g/Nm ³ *	20	20	20
Specific energy requirement at nominal capacity	Wh/g	16.5	16.5	16.5
Power factor at full capacity	cos φ	0.95	0.95	0.95
Ozone connection		Rp 3/8"	Rp 3/8"	Rp 3/8"

* Nm³= m³ at standard conditions (P = 1.013x10⁵Pa, T = 273 K)

Electrical Connection

		OZMa 4A	OZMa 5A	OZMa 6A
Connected load	V/Hz/A	400/50;60/16	400/50;60/16	400/50;60/16
Enclosure rating		IP 54	IP 54	IP 54
Degree of protection with integrated air conditioning unit (internal/external)		IP 54 / IP 34	IP 54 / IP 34	IP 54 / IP 34

Overall Dimensions (Without Mixer)

		OZMa 4A	OZMa 5A	OZMa 6A
Width	mm	1,320	1,320	1,606
Height	mm	1,961	1,961	1,961
Depth	mm	605	605	605

Weight

		OZMa 4A	OZMa 5A	OZMa 6A
Weight	kg	420	445	580

Ozone Mixing

		OZMa 4A	OZMa 5A	OZMa 6A
Max. raw water temperature	°C	35	35	35
Permissible pressure at ozone outlet	bar	0.8–2.0	0.8–2.0	0.8–2.0

Air Supply

		OZMa 4A	OZMa 5A	OZMa 6A
Air demand	Nl/min	220	293	440

Air quality oil and dust-free, non-corrosive, constant priming pressure of 4.5 – 10 bar, max. temperature 40 °C

Cooling Water

		OZMa 4A	OZMa 5A	OZMa 6A
Cooling water consumption (15 °C)	l/h	270	360	540
Cooling water consumption (30 °C)	l/h	300	400	600
Cooling water inlet pressure	bar	2–5	2–5	2–5
Cooling water inlet, PE pressure hose	mm	12 x 9	12 x 9	12 x 9
Cooling water outlet, open discharge	mm	12 x 9	12 x 9	12 x 9

Cooling water quality No tendency to form lime scale, no corrosive components, removable substances: < 0.1 ml/l, iron: < 0.2 mg/l, manganese: < 0.05 mg/l, conductivity: > 100 µS/cm, chloride: < 250 mg/l



1 Disinfection Systems and Oxidation Systems

Ozone Generation Systems OZONFILT® OZMa 1-6 O (Operating Gas - Oxygen)

Under nominal conditions, the OZMa 1-6 O range produces up to 735 g/h of ozone from oxygen at a concentration of up to 150 g/Nm³. Using the designated mixing devices, ozone concentrations in the water to be treated of up to 90 ppm can be achieved (theoretical value at 0 °C). Ozone concentration in g/Nm³ and system feed rate in g/h can be varied depending on the operating conditions and can thus be individually matched to the application conditions. Examples for various combinations are listed in the technical data table.

Different feature options can be achieved by combining different Identity code characteristics.

The systems are pre-mounted ready for connection in a painted steel cabinet (optional stainless steel control cabinet) and should only be connected to a single-phase voltage supply, oxygen, cooling water/waste water and ozone metering point on the customer's site.

Identity Code Ordering System for OZONFILT® OZMa Systems see p. → 1-40

Mixing equipment

All OZMa systems are delivered, in principle, without a mixing unit and a suitable mixing system has to be ordered separately. When selecting a suitable mixing system, please note that the mixing of ozone is more efficient the higher the water flow in the mixing system. Accordingly design the mixing system so that the flow of the water to be treated is at the upper range of the flow specification.

We recommend using stainless steel mixing systems because of the high ozone concentrations. Mixing systems made of PVC can have a reduced service life, depending on the operating conditions.

Static Helical Mixer Made of PVC or Stainless Steel see p. → 1-43

Notes on installation

Keep the length of pipes for transporting ozone and the number of joints to a minimum. Monitor all adjoining rooms with a gas detector in line with the applicable German accident prevention regulations. All OZONFILT® systems are equipped for the fitting of a gas detector, such as type Neon® Gas Ozone.

Gas detector Neon® Gas Ozone See page → 1-45

Depending on the operating and installation conditions, it might also be necessary to monitor the room air for excessive oxygen content.

Ensure that all accessories that transport gas are resistant to ozone and oxygen (e.g. grease-free).

Ozonisation adds a large amount of gas to the water of which only a small percentage can dissolve. Accordingly, provide for adequate bleeding. As the gases discharged in this way have a considerable residual ozone concentration, appropriate residual ozone destructors should be installed. Due to the high ozone concentrations, only catalytic residual ozone destructors can be used. Active carbon-based residual ozone destructors ignite spontaneously if subjected to increased ozone concentrations.

It is necessary for the ozone generation system to be interlocked with the water flow to the ozone metering on all installations.

Install a non-return valve between the OZMa and the ozone point of injection to prevent the return of ozonised water into the pipe that transports the ozone.

Room Air Monitoring see p. → 1-45, Residual Ozone Gas Destructor see p. → 1-44



1 Disinfection Systems and Oxidation Systems

Technical Data

Ozone Generation Systems OZONFILT® OZMa 1-3 O (Operating Gas - Oxygen)

Ambient parameters

Max. 85% air humidity of the ambient air, non-condensing, non-corrosive, dust-free, max. ambient temperature: 40 °C (with integrated air conditioning system: 50 °C)

		OZMa 1 O	OZMa 2 O	OZMa 3 O
Number of generator modules		1	1	1
Nominal ozone capacity at 100 g/Nm³ ** and cooling water at 15 °C	g/h	105	158	210
Ozone capacity at 150 g/Nm³ *	g/h	60	90	120
Ozone capacity at 80 g/Nm³	g/h	123	184	245
Specific energy requirement at nominal capacity	Wh/g	9	9	9
Power factor at full capacity	cos φ	0.95	0.95	0.95
Ozone connection		Rp 3/8"	Rp 3/8"	Rp 3/8"

Electrical Connection

		OZMa 1 O	OZMa 2 O	OZMa 3 O
Connected load	V/Hz/A	230/50;60/10	230/50;60/16	230/50;60/16
Enclosure rating		IP 54	IP 54	IP 54
Degree of protection with integrated air conditioning unit (internal/external)		IP 54 / IP 34	IP 54 / IP 34	IP 54 / IP 34

Overall Dimensions

		OZMa 1 O	OZMa 2 O	OZMa 3 O
Width	mm	1,114	1,114	1,114
Height	mm	1,961	1,961	1,961
Depth	mm	400	400	400

Weight

		OZMa 1 O	OZMa 2 O	OZMa 3 O
Weight	kg	220	230	250

Ozone Mixing

		OZMa 1 O	OZMa 2 O	OZMa 3 O
Max. raw water temperature	°C	35	35	35
Permissible pressure at ozone outlet	bar	0.8–2.0	0.8–2.0	0.8–2.0

Specification of Operating Gas: Oxygen

		OZMa 1 O	OZMa 2 O	OZMa 3 O
Gas volume at nominal capacity 100 g/Nm³	NI/h	1,050	1,580	2,100
Gas volume at capacity 150 g/Nm³	NI/h	400*	600*	800*
Gas volume at capacity 80 g/Nm³	NI/h	1,540	2,300	3,100
Concentration min.	vol%	90	90	90
Dew point max.	°C	-50	-50	-50
Pressure	bar	3–6	3–6	3–6
Max. particles	µm	5	5	5
Max. hydrocarbons	ppm	20	20	20
Max. temperature	°C	30	30	30

Cooling Water

		OZMa 1 O	OZMa 2 O	OZMa 3 O
Cooling water consumption (15 °C)	l/h	70	105	140
Cooling water consumption (30 °C)	l/h	115	175	400
Cooling water inlet pressure	bar	1–5	1–5	1–5
Cooling water inlet, PE pressure hose	mm	12 x 9	12 x 9	12 x 9
Cooling water outlet, open discharge	mm	12 x 9	12 x 9	12 x 9

Cooling water quality No tendency to form lime scale, no corrosive components, removable substances: < 0.1 ml/l, iron: < 0.2 mg/l, manganese: < 0.05 mg/l, conductivity: > 100 µS/cm, chloride: < 250 mg/l

* Output 150 g/Nm³ as special version must be factory-set

** Nm³ = m³ at standard conditions (P = 1.013x10⁵ Pa, T = 273 K)



1 Disinfection Systems and Oxidation Systems

Ozone Generation Systems OZONFILT® OZMa 4-6 O (Operating Gas - Oxygen)

Ambient parameters

Max. 85% air humidity of the ambient air, non-condensing, non-corrosive, dust-free, max. ambient temperature: 40 °C (with integrated air conditioning system: 50 °C)

		OZMa 4 O	OZMa 5 O	OZMa 6 O
Number of generator modules		2	2	3
Nominal ozone capacity at 100 g/Nm ³ ** and cooling water at 15 °C	g/h	320	420	630
Ozone capacity at 150 g/Nm ³ *	g/h	180	240	360
Ozone capacity at 80 g/Nm ³	g/h	370	490	735
Specific energy requirement at nominal capacity	Wh/g	9	9	9
Power factor at full capacity	cos φ	0.95	0.95	0.95
Ozone connection		Rp 3/8"	Rp 3/8"	Rp 3/8"

Electrical Connection

		OZMa 4 O	OZMa 5 O	OZMa 6 O
Connected load	V/Hz/A	400/50;60/16	400/50;60/16	400/50;60/16
Enclosure rating		IP 54	IP 54	IP 54
Degree of protection with integrated air conditioning unit (internal/external)		IP 54 / IP 34	IP 54 / IP 34	IP 54 / IP 34

Overall Dimensions

		OZMa 4 O	OZMa 5 O	OZMa 6 O
Width	mm	1,320	1,320	1,606
Height	mm	1,961	1,961	1,961
Depth	mm	605	605	605

Weight

		OZMa 4 O	OZMa 5 O	OZMa 6 O
Weight	kg	420	445	580

Ozone Mixing

		OZMa 4 O	OZMa 5 O	OZMa 6 O
Max. raw water temperature	°C	35	35	35
Permissible pressure at ozone outlet	bar	0.8–2.0	0.8–2.0	0.8–2.0

Specification of Operating Gas: Oxygen

		OZMa 4 O	OZMa 5 O	OZMa 6 O
Gas volume at nominal capacity 100 g/Nm ³	Nl/h	3,200	4,200	6,300
Gas volume at capacity 150 g/Nm ³	Nl/h	1,200*	1,600*	2,400*
Gas volume at capacity 80 g/Nm ³	Nl/h	4,630	6,130	9,190
Concentration min.	vol%	90	90	90
Dew point max.	°C	-50	-50	-50
Pressure	bar	3 – 6	3 – 6	3 – 6
Max. particles	µm	5	5	5
Max. hydrocarbons	ppm	20	20	20
Max. temperature	°C	30	30	30

Cooling Water

		OZMa 4 O	OZMa 5 O	OZMa 6 O
Cooling water consumption (15 °C)	l/h	200	280	420
Cooling water consumption (30 °C)	l/h	300	400	600
Cooling water inlet pressure	bar	1–5	1–5	1–5
Cooling water inlet, PE pressure hose	mm	12 x 9	12 x 9	12 x 9
Cooling water outlet, open discharge	mm	12 x 9	12 x 9	12 x 9

Cooling water quality No tendency to form lime scale, no corrosive components, removable substances: < 0.1 ml/l, iron: < 0.2 mg/l, manganese: < 0.05 mg/l, conductivity: > 100 µS/cm, chloride: < 250 mg/l

* Output 150 g/Nm³ as special version must be factory-set

** Nm³ = m³ at standard conditions (P = 1.013x10⁵Pa, T = 273 K)



1 Disinfection Systems and Oxidation Systems

Identity Code Ordering System for OZONFILT® OZMa Systems

OZMa	Type	Air operation / Oxygen operation	
		g/h	g/h
01		70	105
02		105	158
03		140	210
04		210	320
05		280	420
06		420	630
Operating gas			
A	Operating gas - air		
O	Operating gas - oxygen		
Type			
P	ProMinent		
S	Special version		
C	ProMinent with air-conditioning		
Mechanical design			
0	Standard (packaging for transport by HGV)		
1	Standard (packaging for sea/air freight)		
2	In stainless steel cabinet (packaging for transport by HGV)		
3	In stainless steel cabinet (packaging for sea/air freight)		
M	Modified		
Operating voltage			
A	Single-phase 230 V ±10%, 50/60 Hz (only types 01-03)		
S	Three-phase 230/400 V ±10%, 50/60 Hz (only types 04-06)		
Gas treatment			
0	Gas treatment not integrated (design operating gas - oxygen)		
1	Gas treatment integrated without filter package (design operating gas - air)		
2	Gas treatment integrated with filter package (design operating gas - air)		
3	Gas treatment not integrated (oxygen operating gas version), including gas control valve		
4	Gas treatment integrated without filter package (air operating gas version), including gas control valve		
5	Gas treatment integrated with filter package (air operating gas version), including gas control valve		
Preset language			
DE	German		
EN	English		
FR	French		
IT	Italian		
ES	Spanish		
Control			
0	Basic version with digital input to control two power stages		
1	External power control via 0/4-20 mA input, data logger		
2	External power control, ozone measurement and visualisation via screen recorder, 2 freely configurable 0/4-20 mA inputs, 1 freely configurable 0/4-20 mA output		
3	As 2 with additionally integrated PID controller for control of the ozone concentration independent of measured value and flow		
Communication interfaces			
0	None		
2	Modbus TCP		
4	PROFIBUS®-DP interface		
Additional options			
0	None		
1	Dew point sensor		
Approvals			
01	CE-mark		
Hardware			
0	Standard		
Software			
0	Standard		

Explanation on the Identity code:

Mechanical design: In design 0 and 1, the plant is installed in a standard control cabinet made of powder-coated steel.

Gas treatment: Without filter package for oil-free generated or de-oiled compressed air.
With filter package for compressed air with residual oil content.



1 Disinfection Systems and Oxidation Systems

1.2.7

Accessories and Spare Parts for Ozone Systems

Compressors for OZONFILT® OZVb 1 – 4

Atlas Copco LFX compressors

This compressor product range stands out on account of its value for money and is equipped with active start-up unloading and automatic condensation drainage by solenoid valve. The compressors are not suitable for continuous operation and stand out on account of their expected service life of up to 5,000 hours. The efficient use of the compressor can only be guaranteed if the operating duration of the OZVb system can be set as low as possible.

Type		LFX 0.7	LFX 1.5
Free air delivery rate at 7 bar	l/min	61	124
Power consumption at 7 bar	W	530	970
Number of cylinders		1	1
Sound pressure level	dB(A)	62	64
Air receiver capacity	l	20	20
Weight	kg	44	48
suitable for OZVb type		1 + 2	3 + 4

Type	Type	Order no.
LFX 0.7	230 V/50 Hz	1004458
LFX 0.7	230 V/60 Hz	1010719
LFX 1.5	230 V/50 Hz	1006343
LFX 1.5	230 V/60 Hz	1009638

Air filter kit

	Order no.
Air filter kit for Atlas Copco LFX compressors	1005789

Compressors Dürr piston compressor

The outstanding feature of this continuously rated range of compressors is their extremely robust construction, making them ideally suitable for industrial use. They are equipped with active start unloading, automatic condensate discharge by solenoid valve and an hours-run meter. PTFE coated special aluminium pistons lead to the long service life and reliability of these compressor units.

Type		TA-080	HA-200 AK
Free air delivery rate at 7 bar	l/min	62	120
Supply max.	VAC	230	230
Supply frequency	Hz	50/60	50
Power consumption at 7 bar	W	800	1,370
Number of cylinders		1	2
Sound pressure level	dB(A)	68	69
Air receiver capacity	l	25	55
Weight	kg	49	62
suitable for OZVb type		1 + 2	3 + 4

Type	Order no.
TA-080	1025398
HA-200 AK	1105981



1 Disinfection Systems and Oxidation Systems

Spare parts for piston compressor TA-080

	Order no.
Air filter kit	1025400

Spare parts for piston compressor HA 200 AK

	Order no.
Air filter kit; 1 no. needed per plunger	1105982
Vibration damper set	1105983
Cup seal and cylinder; 1 no. needed per plunger; replace after 8,000 hours of operation	1106034

Oxygen generator for OZONFILT® OZMa 10

OXYMAT 020 eco

This compact oxygen generator works on the principle of pressure swing filtration of the ambient air through a molecular sieve. Oxygen is generated with a purity of up to 95% and a dew point of -70 °C when supplied with suitably dried compressed air. The system generates a pressure of 4 bar at the oxygen outlet and can be connected directly to the OZMa 10.

(At 90% oxygen yield):

Type	OXYMAT 020 eco
Capacity	1.6 Nm ³ /h
Air requirement (min. 6 bar)	0.31 Nm ³ /min
Power consumption incl. compressor	2.5 kW
Specific energy requirement	1.4 kWh/Nm ³

Example of an installation

Quantity		Order no.
1	Kaeser SX 3 screw compressor (oil-greased), Motor 2.2 kW, integral cyclone filter	on request
3	Connecting set, hose with quick-release coupling 1/2" – 3/4" external thread at both sides, length 1.2 m	1025388
2	Pressure tank O ₂ for Oxyamat O 020 eco, 90 l, 11 bar, PED with revision opening	1044986
1	Refrigeration dryer ACT 5, 33 Nm ³ /h, 1/230 – 240 V	on request
1	Filter set 006, for LE 2-10 and GX 2-10 FF	1025387
1	Hexagonal reducing piece R 3/4 -Rp 1/2 1.4571	1003366
1	OXYMAT 020 eco, 110-240 V / 50-60 Hz	1044799
1	Connecting set with connectors for 6x4 mm PTFE hose, for connection between OXYMAT and OZVb and OZMa 10	1025395

Accessories

	Order no.
PTFE hose 6x4 mm, admissible operating pressure 15 bar, sold in metres	037426
Service kit for Atlas Copco LE 2-10, (recommended after 8000 running hours)	1025390
Service kit for Atlas Copco GX 2-10 FF, (recommended after 8000 running hours)	1025391
Service kit 006	1025392
Maintenance set for screw compressor SX3	on request
Maintenance set for OXYMAT 020 eco	on request



1 Disinfection Systems and Oxidation Systems

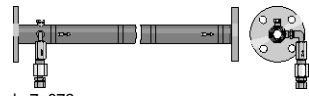

pk_7_072
Static Helical Mixer

Static Helical Mixer Made of PVC or Stainless Steel

Designed for intensive mixing of gas with liquid flows. 4 helical blades ensure optimum mixing of the ozone with minimal pressure loss (0.1 bar per blade at maximum flow rate). The specified flow range of the static helical mixer should be observed to achieve optimum mixing results.

Version with loose flanges to DIN 2501 and integrated injection point made of stainless steel with threaded connector for 12 mm diam. stainless steel tube or 12/9 mm PTFE hose using stainless steel support inserts. The injection point should also be fitted with a non-return valve to protect the ozone system from back flowing water. The mixers are supplied grease-free. The stainless steel version has a G 1/4" manometer connection at the mixing point of the ozone.

Flow m ³ /h	Material	Overall length mm	Connector	Order no.
5 – 10	PVC-U	718	DN 40	1024324
10 – 15	PVC-U	718	DN 50	1024325
15 – 25	PVC-U	718	DN 65	1024326
25 – 35	PVC-U	1,100	DN 80	1024327
35 – 50	PVC-U	1,100	DN 100	1024328
50 – 90	PVC-U	1,300	DN 125	1034641
95 – 160	PVC-U	1,700	DN 150	1034640
5 – 10	1.4404	718	DN 40	1022503
10 – 15	1.4404	718	DN 50	1022514
15 – 25	1.4404	718	DN 65	1022515
25 – 35	1.4404	1,100	DN 80	1022516
35 – 50	1.4404	1,100	DN 100	1024154

Other sizes on request

Connecting parts for the gas pipeline

	Order no.
Stainless steel pipe 12/10 mm, sold in metres	015743
Stainless steel pipe 12/10 mm, grease-less, 1.4 m	1022463
PTFE hose 12/9 mm, grease-less, sold in metres	037428
Stainless steel support inserts, 2 No. for 12/9 mm PTFE hose, grease-less	1025397
Stainless steel coupling 12 mm - R 1/4, grease-less	1025755
Stainless steel fitting 12 mm - R 3/8, grease-less	1034642
3/8" double nipple	1005825
Stainless steel 90° elbow D 12 - D 12, grease-less	1022462
Stainless steel back pressure valve, adjustable pressure range 0.07 – 2 bar, connection size 1/4" NPT, 2 additional inputs for the connection of 2 manometers for OZVb 1 – 4 and OZMa 1 – 3 O	1029032
Stainless steel back pressure valve for OZMa 1 – 3 A and OZMa 4 – 6 O, adjustable pressure range 0.5 – 10 bar, connector G 3/4" external thread, grease-free	1039408
Spare parts kit for back pressure valve order no. 1039408	1039410
Stainless steel back pressure valve for OZMa 4 – 6 A, adjustable pressure range 0.5 – 10 bar, connector G 1 1/4" external thread, grease-free	1039409
Spare parts kit for back pressure valve order no. 1039409	1039411

Accessories for OZONFILT® OZMa

The remote control module for OZMa systems enables bidirectional communication with the system control. Communication takes place optionally via a LAN, MPI or USB communication interface.

	Order no.
Remote control module for OZMa systems	On request



1 Disinfection Systems and Oxidation Systems

1

Bleed Valves

Suitable for types	Connector	Pressure bar	Max. gas flow at $\Delta p = 0.1$ bar Nm ³ /h	Order no.
OZVb 1 – 7	R 3/4" female; R 1/2" male	0 – 6.0	3.1	302525
OZMa 1 – 30/OZMa 1A	R 1" female; R 1/2" male	0 – 2.0	3.1	302526
OZMa 2-4A / OZMa 4-6O	R 1" female; R 3/4" male	0 – 2.0	14.0	303845
OZMa 2-4A / OZMa 4-6O	DN65" female x 3/4" male	0 – 2.0	25.0	1026373

Bleed valves made of stainless steel 1.4571 in ozone-resistant version for mounting on reaction tanks.

Residual Ozone Gas Destructor

Residual ozone gas destruction is used to remove traces of ozone gas from the exhaust air coming from the reaction tank. Because the exhaust air from the reaction tank still contains water, the pipework should be suitably routed so as to ensure that the water is drained off at the inlet side.

A suitable drainage connection should be provided here too as the exhaust air after the residual ozone gas destructor is still up to 100% saturated with water vapour, and because small temperature fluctuations, even on the outlet side, can lead to flowback of condensate.

The exhaust air from any downstream filter plant that may be fitted can also be routed via this ozone gas destruction unit.

PVC version

Residual ozone destructor based on granular activated carbon in a PVC housing.

	Type	Ozone quantity g/h	Order no.
Residual ozone destructor 3 L	10	10	879022
Residual ozone destructor 14 L	40	40	1004267
Residual ozone destructor 30 L	100	100	879019
Residual ozone destructor 60 L	200	200	879018

Note:

The stated ozone quantities refer to quantities added to the raw water. The residual ozone destructor is designed for the normal residual ozone concentration found in swimming pool applications. It should only be used in plants with air as operating gas and a maximum concentration of 1.5 g of ozone/m³ treated water.

Stainless steel version

Residual ozone destructor based on a maintenance-free MnO catalytic converter with integrated heating, 230 V, 50-60 Hz. Connections Rp 1/2" or flanges to DIN 2642, PN10. Types 18 to 110 m³/h also fitted with Rp 1/2" ball valve as condensate drain.

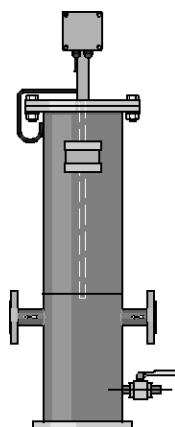

pk_7_073
Residual ozone destructor

Max. gas flow m ³ /h	Heating power W	Dimensions H x W x D mm	Connector	Order no.
1.5	100	700 x 110 x 180	Rp 1/2"	1018440
8.0	100	735 x 110 x 235	Rp 1/2"	1018406
18.0	140	1,154 x 275 x 240	DN 25	1019155
28.0	140	1,154 x 300 x 259	DN 25	1021037
40.0	500	1,156 x 330 x 264	DN 25	1026335
73.0	500	1,158 x 400 x 320	DN 32	1019971
110.0	500	1,160 x 450 x 375	DN 40	1027238

Note:

The catalytic residual ozone destructor should only be used in chlorine-free gas flows. The PVC version should therefore be used for swimming pool applications.



1 Disinfection Systems and Oxidation Systems

1.2.7.1 Room Air Monitoring

Gas detector Neon® Gas Ozone

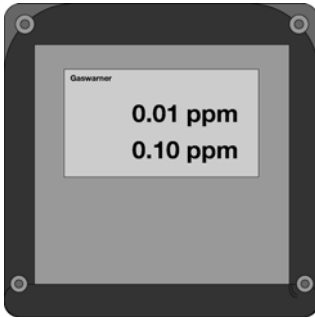

P_DV_0030_SW

The gas detector type Neon® Gas Ozone is designed as a compact measuring and switching unit for monitoring the ambient air for dangerous concentrations of ozone.

Type	Ozone
Warning at approx.	0.3 ppm/vol%
Alarm at approx.	0.5 ppm/vol%
Permissible ambient temperature	0...50°C
Protection class housing	IP 65
Dimensions (without PGs, without sensor) H x W x D	144 x 144 x 156 mm
Supply	85 – 265 / 50 – 60
Power consumption	10 W
Warm-up phase max.	150 s
"Warning" relay contact, self-resetting	250 V ; 6 A
"Alarm" relay contact, latching	250 V ; 6 A
"Horn" relay contact, latching, can be acknowledged	250 V ; 6 A
Sensor measuring principle	electrochemical
Sensor service life (depending on ambient conditions)	1Year

Note: The sensor reacts to all oxidising gases.

	Order no.
Gas detector Neon® gas including gas sensor bracket and 10 m connecting cable for 1 sensor and ozone sensor 230 V	1083254
Gas detector Neon® Gas including gas sensor, 10 m connecting cable for 1 sensor and ozone sensor 24 VDC	1093888

Accessories for connecting an additional sensor

	Order no.
Gas sensor support	1082466
Connecting cable 5x0.25 mm ² 10 m	1082467
Ozone sensor 5 ppm	1104364

Flash light-horn



Combined horn and red warning lamp. IP 65 housing made of impact-resistant grey polycarbonate with a transparent polycarbonate dome. Rating values: 230 V AC, 50 mA.

	Order no.
Flash light-horn, red with continuous tone	1083160

Gas tracing pump

Hand operated, non-continuously working test tube pump for fast and accurate measurement of ozone gas. Complete with 10 no. ozone gas test tubes 0.05-5 ppm in carrying case.

	Order no.
Gas tracing pump	1025533



1 Disinfection Systems and Oxidation Systems

Potassium iodide starch paper

Roll with 4.8 m test strip for leak detection on pipelines carrying ozone gas.

	Order no.
Potassium iodide starch paper	1025575

Cooling Water Heat Exchanger

A heat exchanger can be used as an alternative to the use of fresh water as cooling water. The cooling water is fed through the heat exchanger and ozone system in a circuit. The cooling water heat exchanger discharges the heat to the surroundings.

- Single circuit system with tank open to the atmosphere
- Air-cooled refrigeration unit
- Integral evaporator
- Tank with water level display and level switch with alarm contact
- Microprocessor-controlled temperature controller with digital display
- Integrated circulation pump
- Manometer
- Stainless steel housing
- Installation material with 10 m hose for direct connection to the ozone system
- Electrical contact inputs/outputs: On/Off contact, alarm contact, min. water level contact

		1075498	1075499	1075501
Order no.				
Refrigerant	CFC-free	R134a	R134a	R134a
Useful cooling output at 20 °C/50 Hz	kW	2.1	2.1	3.0
Working range	°C	+10/+30	+10/+30	+10/+30
Ambient temperature	°C	10 – 55	10 – 55	10 – 55
Pump	Type	Speck, LNY-2841	Speck, LNY-2841	Speck, LNY-2841
Pump capacity at 2 bar	l/min	3.4	3.4	3.4
Water connectors	Inch	6 x 4	12 x 9	12 x 9
Power consumption	kW	1.9	1.9	1.9
Mains connection	V/Hz	230/50 – 60	230/50 – 60	230/50 – 60
Degree of protection	IP	44	44	44
Weight	kg	63	63	83
Outside dimensions (W x D x H)	mm	770x560x562	510 x 770 x 500	510 x 770 x 500

	Suitable for type	Order no.
Cooling water heat exchanger	OZVb 1 – 4	1075498
	OZMa 1 – 2 A, OZMa 1 – 2 O	1075499
	OZMa 3 A, OZMa 3 O	1075501



1 Disinfection Systems and Oxidation Systems

1.2.7.2 Personal Protection Accessories

Gas mask

Ozone-resistant, full-face respiratory protective mask with panoramic window shield to EN 136 Class 3. Medium size with EN 148-1 threaded pipe connection. Complete with combination filter NO-P3 and carrying case.

	Order no.
Gas mask	1025574

Warning label

Warning label in accordance with the "Guidelines for the use of ozone for water treatment" ZH 1/474, issued by the central office of the industrial safety associations. Version supplied as a combined adhesive label with markings as follows: warning sign, ozone plant room indication and prohibited activity signs.

	Order no.
Warning label	740921

Emergency stop switch

For installation near the door of the ozone plant room. IP 65 PVC enclosure.

	Order no.
Emergency stop switch	700560

Overvoltage Protection

Overvoltage protection for OZONFILT® systems operated at 230 V 50-60 Hz.

The external overvoltage protection is intended for the operating case where the device internal protection is insufficient for surge voltages of 1 kV between the conductors and of 2 kV to earth. To protect the system when the supply mains is prone to power transients an overvoltage trip can be fitted as a low protection surge arrester to significantly increase the stability of the ozone systems.

Whether the low protection surge arrester requires further measures such as medium and main protection can only be determined by thorough investigation of the voltage behaviour on site.

	Order no.
Fine protection PT 2-DE IS 230 IAC	733010

Replacement Plug-in Insert After Tripping

	Order no.
Replacement plug-in insert PT 2-DE / S 230 / AC - ST	733011



1 Disinfection Systems and Oxidation Systems

1.2.8

DULCOneX – digital fluid management



Location-independent system monitoring in real time

You always have all the key data and measured values in sight at all times with DULCOneX. Monitor and document the status of your system in real time. Check your unit data, regardless of where you are, safely and reliably when you're out and about. Simply use the terminal device of your choice: smartphone, tablet or PC.

Refer to our catalogue or website for more information and references.



1 Disinfection Systems and Oxidation Systems

1.3 Bello Zon® Chlorine Dioxide Systems

1.3.1 Chlorine Dioxide in Water Treatment

Chlorine dioxide is an exceptionally reactive gas, which is not stored due to its instability but rather must only be manufactured to meet requirements at its place of use in special systems.

Chlorine dioxide has a number of advantages over chlorine, which is predominantly used in the disinfection of water. Thus for instance, the disinfection effect does not reduce with increasing pH-value, as is the case with chlorine, rather it increases slightly. Chlorine dioxide remains stable in pipework systems over long periods of time and provides microbiological protection of the water for many hours and up to several days. Ammonia or ammonium, which cause considerable chlorine loss, do not react with chlorine dioxide so that the metered chlorine dioxide remains fully available for disinfection purposes. Chlorophenols, strongly smelling compounds, which result from the chlorination of water etc., are not formed with chlorine dioxide. Trihalogenmethanes (THMs), a substance class, which, like their main representative, chloroform, is suspected of being carcinogens, result from the reaction of chlorine with dissolved matter naturally found in water (humic acids, fulvic acids, etc.). If chlorine dioxide is used as an alternative disinfectant these substances are not produced.

Advantages of chlorine dioxide:

- Disinfectant effect regardless of the pH value.
- Excellent depositing effect, thanks to long-term stability in the pipework.
- Degradation of biofilms in pipework and tanks, thus reliable protection of entire water systems against legionella attack.
- No reaction with ammonia or ammonium.
- No formation of chlorophenols and other strongly smelling compounds that can be produced during water chlorination.
- No formation of trihalomethanes (THM) or other chlorinated hydrocarbons, no increase in AOX values.

Chlorine Dioxide Applications

With every new project, our engineers draw on experience that we have accumulated since 1976 in the following applications:

Municipal potable water and waste water companies

- Disinfection of potable water
- Disinfection of waste water

Hotels, hospitals, care homes, sports centres etc.

- Combating legionella in cold and hot water systems
- Water disinfection in the cooling towers of air conditioning systems
- Disinfection of swimming pool filters

Food and beverage industry

- Disinfection of product and raw water
- Bottle cleaning, rinsers and pasteurisers
- Cold-sterile bottling systems
- Disinfectant in CIP systems
- Water vapour treatment (condensation) in the milk industry
- Water treatment for fruit, vegetable, seafood, fish and poultry processing

Market gardening

- Disinfection of irrigation water in plant cultivation

Industry

- Cooling water treatment
- Combating legionella in cooling water circuits
- Disinfection of process water
- Removal of odorous substances in air scrubbers
- Slime control in the paper industry



1 Disinfection Systems and Oxidation Systems

Bello Zon® System Technology

Bello Zon® chlorine dioxide generation and metering systems use the chlorite/acid process. These systems generate a chlorine-free chlorine dioxide solution through the reaction of sodium chlorite solution with hydrochloric acid.

Decades of experience with Bello Zon® chlorine dioxide systems have shown that using the selected process parameters can achieve an excellent output of up to 99% (relative to the stoichiometric ratio).

In most applications, metering is proportional to the flow, i.e. the flow depends on the signal from an inductive or contact flow meter or is performed in parallel to a feed pump.

In circulation systems, such as bottle washing machines, cooling circuits, etc., where a chlorine dioxide loss need only be made good, the addition can also be controlled based on a measurement of chlorine dioxide.

Features

- Precise and reproducible chlorine dioxide production, thanks to the use of calibratable metering pumps for the starting chemicals.
- Convenient easy operation, thanks to microprocessor control with display of all relevant operating parameters and error messages in plain text.
- Display of the current production quantity as well as the flow rate of the connected flow meters with CDV and CDK.
- Integrated measurement of ClO_2 and chlorite plus control of ClO_2 with CDV and CDK.
- Highest safety level provided as standard, thanks to construction and operation in accordance with DVGW specifications W 224 and W 624.

Bello Zon® CDL

Compact dimensions and maximum cost-effectiveness - chlorine dioxide system for one or more points of injection.

0 – 120 g/h capacity with storage of up to 60 g of chlorine dioxide for peak metering. Max. flow rate at 0.2 ppm ClO_2 metering capacity of 600 m³/h

Bello Zon® CDE

Bello Zon® CDEb is winning over customers, thanks to its ultra-simple operation and clearly laid out construction.

5-200 g/h chlorine dioxide. Max. flow at 0.2 ppm ClO_2 metering is 1,000 m³/h

Bello Zon® CDV

Bello Zon® CDVc is the convenient system for the treatment of average to large volumes of water.

5 – 2,000 g/h chlorine dioxide. Max. flow at 0.2 ppm ClO_2 metering is 10,000 m³/h

Bello Zon® CDK

Bello Zon® CDKc is a deluxe system, persuading customers with its safe handling of chemicals.

15 – 12,000 g/h chlorine dioxide. Max. flow at 0.2 ppm ClO_2 metering is 60,000 m³/h

ProMinent provides all the advice needed for the safe operation of a chlorine dioxide system:

- Evaluation of the situation on site by trained, expert field sales staff.
- Interpretation of water analysis.
- Project planning of the system.
- Commissioning and system maintenance by our trained service technicians.



1 Disinfection Systems and Oxidation Systems

1.3.2

Performance Overview of Chlorine Dioxide Systems

Type [g/h]	CDLb	CDEb	CDVd	CDKd
15,000				
10,000				15 – 12,000
5,000				
1,000			5 – 2,000	
500				
100	0 – 120	5 – 200		
50				
10				
5				

Manufacturing Method

	Chlorite-Acid (depleted) 7,5 % NaClO ₂ + 9 % HCl	Chlorite-Acid (depleted) 7,5 % NaClO ₂ + 9 % HCl	Chlorite-Acid (depleted) 7,5 % NaClO ₂ + 9 % HCl	Chlorite-Acid (concentrated) 24,5 % NaClO ₂ + 25-37 % HCl
--	--	--	--	---

Application

Legionella combating	■			
Food and beverages industry	■	■	■	
Municipal drinking and waste water treatment	■	■	■	■
Industry (cooling tower, waste/process water, etc.)	■	■	■	■

P_PMA_BEZ_0197_C

Chlorine dioxide is establishing itself more and more as a universal disinfectant in applications such as the disinfection of drinking water and industrial water, washing food or in the treatment of cooling water and waste water. Its effect independent of the pH value of the water ensures systems remain free of biofilms.

- Efficient disinfection in connection with excellent eco-compatibility
- Safe and reliable plant technology
- Worldwide availability of know-how and service



1 Disinfection Systems and Oxidation Systems

1.3.3 Questionnaire on the Design of a Chlorine Dioxide System

Use of the chlorine dioxide plant:

- for disinfection of
 - Drinking water
 - Industrial water
 - Process water in the food industry
 - Waste water
 - Cooling water
 - _____
- for oxidation of
 - Iron, manganese, nitrite, sulphide etc.
 - Swimming pool water
 - Odour
 - _____
- _____

Water values:

- | | | | |
|------------------------------|-----------------------------------|---|--|
| Max. water flow rate | _____ m ³ /h | Maximum water pressure | _____ bar |
| Water flow rate | <input type="checkbox"/> constant | <input type="checkbox"/> fluctuating from | _____ m ³ /h to _____ m ³ /h |
| pH value | _____ | Iron (Fe ²⁺) | _____ mg/l |
| Temperature | _____ °C | Manganese (Mn ²⁺) | _____ mg/l |
| Solid fraction | _____ mg/l | Nitrite (NO ₂ ⁻) | _____ mg/l |
| Alkalinity K _{S4,3} | _____ mmol/l | Sulphide (S ²⁻) | _____ mg/l |
| | | TOC (total organic carbon) | _____ mg/l |

Response time to application:

_____ m³ volume reaction tank or _____ minutes residence time in entire system.

Type of metering:

- constant
- flow-proportional
- depending on measured value

Desired amount of metering: _____ mg/l

Desired concentration after chlorine dioxide metering: _____ mg/l

Other requirements:

1



1 Disinfection Systems and Oxidation Systems

1.3.4 Chlorine Dioxide System Bello Zon® CDLb

Compact dimensions and maximum cost-effectiveness - chlorine dioxide system for one or more points of injection.

0 – 120 g/h capacity with storage of up to 60 g of chlorine dioxide for peak metering. Max. flow rate at 0.2 ppm ClO₂ metering capacity of 600 m³/h



Chlorine dioxide system for production of a chlorine-free chlorine dioxide solution, especially suitable for multiple points of injection. Bello Zon® CDLb produces ClO₂ discontinuously using the acid/chlorite process with diluted chemicals.



In batch production a chlorine-free chlorine dioxide solution is generated from a sodium chlorite solution and hydrochloric acid. This is an extremely safe, managed process.

The concentration of the chlorine dioxide solution remains constant even during storage. This means that the chlorine dioxide can be buffered in an integrated or external storage module at a concentration of 1,000 or 2,000 mg/l.

Because the chlorine dioxide is buffered in this module, the system can be designed in line with average rather than peak consumption. This drastically reduces investment costs in comparison with conventional systems.

The ProMinent® product range includes a wide range of metering pumps and control versions from which to choose when operating several injection points using chlorine dioxide from a storage module.

No chlorine dioxide can escape from the system due to the closed gas transport system, thereby guaranteeing economical, environmentally friendly operation with minimal use of chemicals. In addition, the chlorine dioxide solution generated with maximum output offers excellent long-term stability with minimal consumption of starting chemicals.

Integration of the system into your process is simple and reliable with the wide range of accessory modules. Please ask our sales representatives for information about our modular systems specifically designed for CDLb.

The chlorine dioxide system Bello Zon® CDLb meets the high standards stipulated in data sheets W 224 and W 624 published by the German Association for Gas and Water (DVGW).

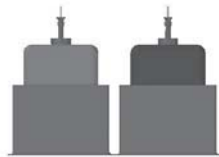

Your benefits

- Reduced costs thanks to minimal use of chemicals
- Cost-effective way to provide several points of injection
- Quick ramp-up time after downtime thanks to long-term stability of chlorine dioxide liquid
- Maximum output due to closed gas transport system
- Outstanding operating safety and reliability, thanks to intrinsically safe process control
- Location-independent system monitoring in real time via the DULCOneX platform: Improved process reliability. Reliability and transparency due to real-time monitoring, individual alarms and automated reports.
- Ultra-simple process integration

Technical Details

Voltage supply	100 – 230 V, 50/60 Hz (16 A)
Inputs	2 freely configurable digital inputs for the functions Pause, High metering, Intermittent metering or Manual metering, as well as an external collective malfunction signal 4 digital inputs for monitoring (warning / empty message) the chemical supply 1 digital input for contact water meter 0.25-20 Hz 1 frequency input for water meter 10-10,000 Hz
Outputs	1 operating signal relay 1 alarm signal relay 1 warning signal relay 1 voltage output +5 V as supply voltage for a water meter with Hall sensor
Operating fluids	Sodium chlorite 7.5%, purity according to EN 938 Hydrochloric acid 9% purity according to EN 939 Potable water
Enclosure rating	IP 65

P_PMA_BEZ_0165_SW1

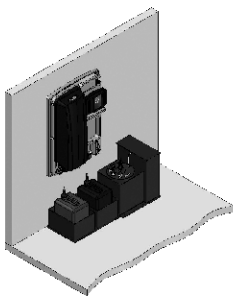

P_PMA_BEZ_0122_SW



1 Disinfection Systems and Oxidation Systems

Field of application

- Disinfection in the food and beverage industry. Especially for bottle rinsers, CIP (cleaning in place), bottle washing machines and fruit / vegetable washing
- Legionella control and prevention, e.g. in hotels or hospitals
- Market gardening: Germ-free irrigation water and sprinkler irrigation water
- Treatment of cooling water and potable water
- Filter disinfection, e.g. in swimming pools

Technical Data

Type	Generation capacity g/h	Operating temp. °C	Solution concentration mg/l	Capacity l/h	Dimensions (approx.) H x W x D (mm) mm	Weight kg
CDLb 06	6*	10–40	1,000	8	1,236 x 878 x 306	41
CDLb 12	12*	10–40	2,000	8	1,236 x 878 x 306	42
CDLb 22	22*	10–40	2,000	13	1,236 x 878 x 306	46
CDLb 55	55* 1)	10–40	2,000	30	1,550 x 800 x 345	73
CDLb 120	120** 1)	10–40	2,000	**	1,300 x 880 x 425	55

* Option: Integrated receiver tank and integrated metering pump with suitable capacity up to 7 bar back pressure.

** With external receiver module and separate metering pump

1) Without cover

Interfaces

Type CDLb		6 g/h	12 g/h	22 g/h	55 g/h	120 g/h
Water inlet	ProMinent/Neutral	12-9	12-9	12-9	12-9	Di20/DN15
	Swiss	Di20/DN15	Di20/DN15	Di20/DN15	Di20/DN15	Di20/DN15
Connector dimensions of metering pump for acid and chlorite		6x4	6x4	6x4	6x4	6x4
ClO₂ output	with internal storage/pump/back pressure valve	6-4	6-4	12-9	12-9	
	with internal storage tank/pump	6-4	6-4	12-9	12-9	
	with internal storage tank, without pump	6-4	6-4	8-5	12-9	
	with external storage tank, without pump (reactor outlet)	12-9	12-9	12-9	12-9	Di25/DN20
	external storage tank (suction lance connector)	Di25/DN20	Di25/DN20	Di25/DN20	Di25/DN20	Di25/DN20



1 Disinfection Systems and Oxidation Systems

Identity Code Ordering System for Chlorine Dioxide Systems Bello Zon® CDLb

CDLb	ClO ₂ production capacity
02	CDLb 06 = 6 g/h
04	CDLb 12 = 12 g/h
06	CDLb 22 = 22 g/h
08	CDLb 55 = 55 g/h, cover now included with the scope of delivery
10	CDLb 120 = 120 g/h, cover now included with the scope of delivery
Equipment	
0	With receiver tank and pump and back pressure valve (not with CDLb 120) *
1	With receiver tank and pump (not with CDLb 120) *
2	With receiver tank, without pump (not for CDLb 120)
3	With 30 l receiver module, without pump
Design	
P	ProMinent
S	Swiss, DN 15 water connection, rigid piping
N	Neutral
Operating voltage	
0	230 V, 50/60 Hz
1	115 V, 50/60 Hz
Suction lance, suction assembly	
0	None
1	With suction lance
2	With suction lance and collecting pan
3	With suction lance, collecting pan, angle valve and PE hose 12x9 (10 m)
Pre-set language	
DE	German
EN	English
ES	Spanish
FR	French
IT	Italian
PL	Polish
CZ	Czech
FI	Finnish
HU	Hungarian
PT	Portuguese
NL	Dutch
SL	Slovenian
RO	Romanian
CN	Chinese
DK	Danish

* ClO₂ discharge pumps are not equipped with a fault indicating relay. It is available as an accessory.

Accessories and Maintenance Sets for Chlorine Dioxide Systems Bello Zon® CDLb

Point of injection

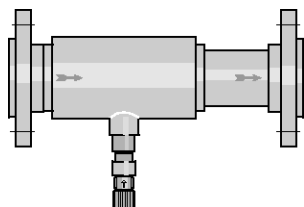

pk_7_066

Corrosion-resistant point of injection made of PVC-U or PVC-C for warm water applications with integrated mixer elements and maintenance-free PVDF metering valve.

CDL points of injection with flange	Material	Installation length mm	Order no.
CDL DN 50 point of injection	PVC-U	450	1027611
CDL DN 65 point of injection	PVC-U	400	1026490
CDL DN 80 point of injection	PVC-U	400	1027612
CDL DN 100 point of injection	PVC-U	470	1034693
CDL DN 125 point of injection	PVC-U	550	1047692
CDL DN 150 point of injection	PVC-U	680	1047693
CDL DN 50 point of injection	PVC-C	450	1080375
CDL DN 65 point of injection	PVC-C	400	1029326
CDL DN 80 point of injection	PVC-C	400	1029327



1 Disinfection Systems and Oxidation Systems

CDL points of injection with threaded connector (including separate reductions in each case to one nominal width smaller)	Material	Order no.
CDL DN 25 point of injection	PVC-C	1080362
CDL DN 40 point of injection	PVC-C	1080374
CDL DN 25 point of injection	PVC-U	1080359
CDL DN 40 point of injection	PVC-U	1080361

Temperature/pressure resistance – metering station CDL

Water temperature (°C)	Maximum permissible operating pressure (bar)	
	PVC-U	PVC-C
40	12	12
50	7	9.5
60	4.5	7.5
70	–	5
80	–	3

Back pressure valve and angle valve

Back pressure valve type MFV with wall bracket and 6 x 4 mm hose connection is ideal for fitting in the chlorine dioxide metering line. Angle valve for the transition from the customer's pipeline to the 12x9 hose connector on the CDLb.

	Order no.
MFV pressure relief valve with wall mounting bracket	1027652
Angle valve (support insert 12/9 stainless steel) DN15 G 1/2" brass	1046350

Fault indicating relay for the ClO₂ pump

Fault indicating relay retrofit kit for the ClO₂ discharge pump

	Order no.
Relay 3-pin	1029309

Hood for CDLb

	Order no.
Hood for CDLb 55 PE black	1045889
Hood for CDLb 120 PE black	1045890

Safety collecting pan for chemical containers

Collecting pan with two separate compartments - 1 No. 25 l Bello Zon® acid and 1 No. 10 l Bello Zon® chlorite chemical container.

Dimensions (HxWxD): 290 x 700 x 350 mm

	Order no.
Safety collecting pan CDLa	1026744



1 Disinfection Systems and Oxidation Systems

Safety collecting pan for chemical tanks (CDLb)

Collecting pan for a 25 l Bello Zon® acid or Bello Zon® chlorite chemical canister.

Dimensions (HxWxD): 266 x 400 x 500 mm

	Order no.
Safety collecting pan CDLb	791726

Service kits for CDLa

The kits contain all parts subject to wear and tear that need to be replaced at regular service intervals. The 1-year kit should be used every year and the 3-year kit in addition every 3 years.

	Order no.
1-year service kit for pressure relief valve	1029442

For CDLa with ClO₂ pump

	Type	Order no.
Annual maintenance kit, 230 V	CDL 5	1027263
3-yearly maintenance set, 230 V	CDL 5	1049659
Annual maintenance kit, 230 V	CDL 10	1031549
3-yearly maintenance set, 230 V	CDL 10	1049665
Annual maintenance kit, 115 V	CDLa 5	1080108
3-yearly maintenance set, 115 V	CDLa 5	1049657
Annual maintenance kit, 115 V	CDLa 10	1080110
3-yearly maintenance set, 115 V	CDLa 10	1049663

For CDLa without ClO₂ pump

	Type	Order no.
Annual maintenance kit, 230 V	CDL5	1042829
3-yearly maintenance set, 230 V	CDL5	1049660
Annual maintenance kit, 230 V	CDL10	1042830
3-yearly maintenance set, 230 V	CDL10	1049666
Annual maintenance kit, 115 V	CDLa 5	1080107
3-yearly maintenance set, 115 V	CDLa 5	1049658
Annual maintenance kit, 115 V	CDLa 10	1080109
3-yearly maintenance set, 115 V	CDLa 10	1049664

Maintenance sets for Bello Zon® CDLb

For CDLb with storage tank, pump and back pressure valve

	Type	Order no.
Annual maintenance kit, 230 V	CDLb 06, CDLb 12	1044484
Annual maintenance kit, 230 V	CDLb 22	1044501
Annual maintenance kit, 230 V	CDLb 55	1044509
Annual maintenance kit, 115 V	CDLb 06, CDLb 12	1079198
Annual maintenance kit, 115 V	CDLb 22	1079202
Annual maintenance kit, 115 V	CDLb 55	1079206
3-yearly maintenance set, 230 V	CDLb 06, CDLb 12	1044494
3-yearly maintenance set, 230 V	CDLb 22	1044502
3-yearly maintenance set, 230 V	CDLb 55	1044510
3-yearly maintenance set, 115 V	CDLb 06, CDLb 12	1045212
3-yearly maintenance set, 115 V	CDLb 22	1045216
3-yearly maintenance set, 115 V	CDLb 55	1045220



1 Disinfection Systems and Oxidation Systems

For CDLb with receiver tank and pump

	Type	Order no.
Annual maintenance kit, 230 V	CDLb 06, CDLb 12	1044495
Annual maintenance kit, 230 V	CDLb 22	1044503
Annual maintenance kit, 230 V	CDLb 55	1044511
Annual maintenance kit, 115 V	CDLb 06, CDLb 12	1079199
Annual maintenance kit, 115 V	CDLb 22	1079203
Annual maintenance kit, 115 V	CDLb 55	1079207
3-yearly maintenance set, 230 V	CDLb 06, CDLb 12	1044496
3-yearly maintenance set, 230 V	CDLb 22	1044504
3-yearly maintenance set, 230 V	CDLb 55	1044512
3-yearly maintenance set, 115 V	CDLb 06, CDLb 12	1045213
3-yearly maintenance set, 115 V	CDLb 22	1045217
3-yearly maintenance set, 115 V	CDLb 55	1045221

For CDLb with receiver tank without pump

	Type	Order no.
Annual maintenance kit, 230 V	CDLb 06, CDLb 12	1044497
Annual maintenance kit, 230 V	CDLb 22	1044505
Annual maintenance kit, 230 V	CDLb 55	1044513
Annual maintenance kit, 115 V	CDLb 06, CDLb 12	1079200
Annual maintenance kit, 115 V	CDLb 22	1079204
Annual maintenance kit, 115 V	CDLb 55	1079208
3-yearly maintenance set, 230 V	CDLb 06, CDLb 12	1044498
3-yearly maintenance set, 230 V	CDLb 22	1044506
3-yearly maintenance set, 230 V	CDLb 55	1044514
3-yearly maintenance set, 115 V	CDLb 06, CDLb 12	1045214
3-yearly maintenance set, 115 V	CDLb 22	1045218
3-yearly maintenance set, 115 V	CDLb 55	1045222

For CDLb with 30 l receiver module without pump

	Type	Order no.
Annual maintenance kit, 230 V	CDLb 06, CDLb 12	1044499
Annual maintenance kit, 230 V	CDLb 22	1044507
Annual maintenance kit, 230 V	CDLb 55	1044515
Annual maintenance kit, 230 V	CDLb 120	1044517
Annual maintenance kit, 115 V	CDLb 06, CDLb 12	1079201
Annual maintenance kit, 115 V	CDLb 22	1079205
Annual maintenance kit, 115 V	CDLb 55	1079209
3-yearly maintenance set, 230 V	CDLb 06, CDLb 12	1044500
3-yearly maintenance set, 230 V	CDLb 22	1044508
3-yearly maintenance set, 230 V	CDLb 55	1044516
3-yearly maintenance set, 230 V	CDLb 120	1044519
3-yearly maintenance set, 115 V	CDLb 06, CDLb 12	1045215
3-yearly maintenance set, 115 V	CDLb 22	1045219
3-yearly maintenance set, 115 V	CDLb 55	1045223
3-yearly maintenance set, 115 V	CDLb 120	1044519



1 Disinfection Systems and Oxidation Systems

1.3.5 Chlorine Dioxide System Bello Zon® CDLb with Multiple Points of Injection

The modular customised solution for several ClO₂ points of injection with only one generation system.

0 – 120 g/h capacity with storage of up to 60 g of chlorine dioxide for peak metering. Max. flow rate at 0.2 ppm ClO₂ metering capacity of 600 m³/h, up to 6 points of injection possible as standard

Flexible solutions for the production and metering of ClO₂ adapted to our customer's tasks, requirements and anticipated pricing.

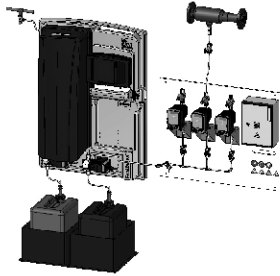

P_PMA_BEZ_0021_SW1
Concept 2

The Bello Zon® chlorine dioxide systems for multiple metering are divided into three different concepts designed to respond to specific customer requirements. These concepts are used where several points of injection need to be supplied with ClO₂ from a single ClO₂ system. Up to 6 points of injection can be selected as standard depending on the chosen concept.

Concept 2 (assembly kit of metering components ready mounted on plate)

This concept consists of two main components, the CDLb system and a metering panel, on which all the metering components are mechanically and, optionally, electrically ready mounted.

Concept 3 (plug and play on stainless steel frame)

This concept consists of a stainless steel frame, on which the BelloZon® CDLb system and the metering components are mechanically and electrically mounted in full. There is a stainless steel control cabinet with a main switch that contains the central power supply and control system for all electrical components.

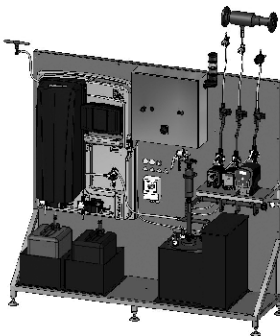

P_PMA_BEZ_0020_SW1
Concept 3

Your benefits

- Very easy way to provide several points of injection according to requirements
- Cost-effective way to provide several points of injection
- Outstanding operating safety and reliability, thanks to intrinsically safe process control
- Ultra-simple process integration
- Location-independent system monitoring in real time via the DULCOnneX platform: Improved process reliability. Reliability and transparency due to real-time monitoring, individual alarms and automated reports.

Technical Details

- External storage module
- Internal storage tank (only with the "Modular, loose components" and "Modular, metering components pre-assembled on a panel" concepts)
- Terminal box with optional main switch (only with the "Modular, metering components pre-assembled on a panel" concept)
- Stainless steel cabinet with main switch and emergency relay (only with the "Plug and Play on stainless steel frame" concept)

Field of application

- All applications which require more than one point of injection
- Disinfection in the food and beverage industry. Especially with bottle rinsers, CIP (cleaning in place), bottle washing machine and in fruit / vegetable washing
- Legionella control and prevention, e.g. in hotels or hospitals (cold and hot water metering)
- Market gardening: germ-free irrigation and sprinkler irrigation water
- Treatment of cooling water and potable water
- Filter disinfection, e.g. in swimming pools



1 Disinfection Systems and Oxidation Systems

1.3.6

Chlorine Dioxide System Bello Zon® CDEb

Bello Zon® CDEb is winning over customers, thanks to its ultra-simple operation and clearly laid out construction.

5-200 g/h chlorine dioxide. Max. flow at 0.2 ppm ClO₂ metering is 1,000 m³/h

Chlorine dioxide system, which continuously produces ClO₂ according to the acid/chlorite method with diluted chemicals. Extremely simple operation, clear construction, analogue control, manual control or via contacts.

A ready-to-use chlorine dioxide system for the continuous production and metering of chlorine dioxide with diluted chemicals. The emphasis is on ultra-simple operation and clearly laid out system design with standard components.

The stroke lengths of the metering pumps are continuously monitored. This rules out inadmissible operating statuses arising from incorrect pump stroke length adjustments.

The system is extremely easy to operate and, alongside a central Start-Stop key, also has colour-differentiated LEDs to display all the operating statuses.

The system can be controlled in an analogue or manual manner or via contacts

Your benefits

- Minimal training required thanks to extremely simple operation
- Minimal investment costs
- Short delivery times
- Excellent operating safety
- Simple process integration
- Location-independent system monitoring in real time via the DULCOneX platform: Improved process reliability. Reliability and transparency due to real-time monitoring, individual alarms and automated reports.

Technical Details

Power supply

- 100-230 V, 50/60 Hz

Inputs

- 1 digital input for the Pause function
- 1 digital input for contact water meter 0.25-20 Hz
- 1 analogue input 0/4-20mA

Outputs

- 1 alarm signal relay
- 1 warning signal relay

Operating substances

- Sodium chlorite 7.5%, purity according to EN 938
- Hydrochloric acid 9% purity according to EN 939
- Particle-free water

Degree of protection

- IP 54

Bypass pipework

- DN 20

Field of application

- Municipal potable water and waste water treatment
- Industrial process and cooling water
- Disinfection in the food and beverage industry

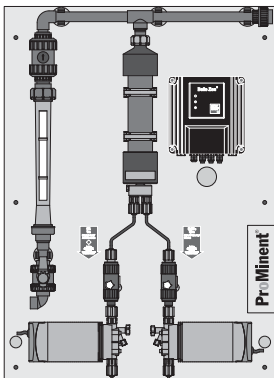

P_PMA_BEZ_0163_SW



1 Disinfection Systems and Oxidation Systems

Technical Data

Type	Chlorine dioxide capacity*		Max. operating pressure **	Operating temp. °C	Connector size, chlorite and acid metering pumps	Dimensions H x W x D mm	Dimensions of the bypass connector DN	Weight kg
	min.-max./hour g/h	min./day g/d						
CDEb 30	5–30	10	7 / 8 **	15–40	6x4	958 x 700 x 250	20	23
CDEb 75	10–75	20	7 / 8 **	15–40	6x4	958 x 700 x 250	20	24
CDEb 200	20–200	40	7 / 8 **	15–40	8x5	958 x 700 x 250	20	27

* The metering figures relate to 5 bar back pressure and an ambient temperature of 20 °C. The minimum capacity/per hour is based on the fact that when the system is operating at below 10 % of the nominal capacity, continuous metering is no longer possible, due to the then low pumping frequency of the metering pumps. Where systems are operating continuously, change the reactor content at least 2 x daily. Do not operate at below the specific minimal output/day.

** 8 bar at maximum 35 °C ambient temperature
Subject to technical and design changes

Type	Order no.
CDEb 30	1079438
CDEb 75	1079439
CDEb 200	1079440

Scope of supply:

Bello Zon® CDEb systems are supplied connection-ready on a wall panel. Connection to the site bypass line is via DN 20 PVC threaded connectors with straight solvent unions. Order suction lances for the chemical pumps, safety collecting pans for the chemical drums and other accessories, like flushing equipment with a vacuum relief valve separately.



1 Disinfection Systems and Oxidation Systems

1.3.7

Chlorine dioxide system Bello Zon® CDVd

Chlorine dioxide system Bello Zon® CDVd is for the treatment of medium to large volumes of water with diluted chemicals.

5 – 2,000 g/h of chlorine dioxide. Maximum volume of water that can be treated with metering of 0.2 ppm ClO₂, depending on the size of the system: 50 - 10,000 m³/h

Chlorine dioxide system for the metering of chlorine dioxide with diluted chemicals. The certified output guarantees efficient chlorine dioxide production. The proven three-stage safety concept protects people and the environment. Bello Zon® CDVd can be easily and safely integrated into any water treatment process.

The chlorine dioxide system CDVd is very user-friendly. The system control stands out due to its intuitive menu guidance and ensures the precise production of chlorine dioxide. The special reactor concept generates chlorine dioxide safely and simply. Chemically resistant PVDF is used instead of the PVC generally used within the industry. You benefit from maximum output with the lowest possible consumption of chemicals combined with the maximum operating safety. Communication via popular bus systems, via web server and our DULCOnneX platform fulfils all the requirements set by the Industry 4.0 standards of tomorrow.

The system meets all the requirements of the DVGW specifications W 224 and W 624 with regard to construction and operation and is intended for operation with diluted chemicals Bello Zon® chlorite (7.5% NaClO₂) and acid (9% HCl). The liquid levels of the starting chemicals can either be displayed and monitored by external liquid level sensors or by an adaptive liquid level monitor that is patent pending.

Your benefits

- Maximum operating safety and purity of the ClO₂ produced by PVDF reactors and three-stage safety concept
- Various communication interfaces via BUS, web server or DULCOnneX
- Ultra-simple and safe operation thanks to intuitive menu guidance
- System does not stop due to empty starting feed chemical tanks, thanks to precise level indicator displays
- Automatic monitoring of operating parameters and maintenance intervals
- Location-independent system monitoring in real time via the DULCOnneX platform: Improved process reliability. Reliability and transparency due to real-time monitoring, individual alarms and automated reports.

Technical Details

Power supply

- 100-230 V, 50/60 Hz

Inputs

- 4 analogue inputs (0/4-20 mA)
 - Water flow
 - Control variable
 - Acid level
 - Chlorite level
- 4 digital inputs
 - Contact water meter 0.25-20 Hz
 - Pause
 - Alternative metering
 - External fault

Outputs

- 1 operating signal relay
- 1 alarm signal relay
- 1 warning signal relay
- Mains output for the control of the bypass pump
- 2 freely configurable analogue outputs (0/4-20 mA)

Operating substances

- Sodium chlorite 7.5 %, purity according to EN 938
- Hydrochloric acid 9% purity according to EN 939
- Particle-free water



1 Disinfection Systems and Oxidation Systems

Degree of protection

- IP 65

Field of application

- Municipal potable water and sewage treatment
- Industrial process and cooling water
- Disinfection in the food and beverage industry, above all with inlet water treatment

Technical Data

Type	Chlorine dioxide capacity*		Max. operating pressure**	Operating temp. °C	Suction-side connector dimension of calibration vessels		Dimensions of the bypass connector
	min.-max./hour g/h	min./day g/d			Chlorite	Acid	
CDVd 45	4.5–45	16	8	10–40	6x4	6x4	25
CDVd 120	12–120	40	8	10–40	6x4	6x4	25
CDVd 240	24–240	80	8	10–40	8x5	8x5	25
CDVd 600	60–600	140	8	15–40	12x9	12x9	25
CDVd 2000	200–2,000	468	5	15–40	Pressure hose nozzle d16	Pressure hose nozzle d16	40

Type	Dimensions*** H x W x D (mm)	Weight kg	Power consumption (max.) ****		Power consumption		Chemical consumption at 100% system capacity *****	
			230 V	115 V	without bypass pump	with bypass pump	HCl (9 %)	NaClO ₂ (7.5 %)
			A	A	W	W	l/h	l/h
CDVd 45	1,300 x 1,000 x 250	55	3.8	1.6	100	630	1.1	1.1
CDVd 120	1,300 x 1,000 x 250	55	3.9	1.6	110	640	2.9	2.9
CDVd 240	1,300 x 1,000 x 250	59	3.9	1.8	120	650	5.7	5.7
CDVd 600	1,525 x 1,160 x 253	84	4.0	1.9	220	750	14.3	14.3
CDVd 2000	2,000 x 1,320 x 290	129	–	2.6	300	–	47.6	47.6

* The metering figures relate to 5 or 2 bar back pressure and an ambient temperature of 20 °C. The minimum capacity/per hour is based on the fact that when the plant is operating at below 5% of the nominal power, continuous metering is no longer possible due to the then low pumping frequency of the metering pumps. The reactor contents should be changed at least twice daily with systems that do not work continuously. Therefore do not operate the system below the stated minimum capacity/day.

** at an ambient temperature of 35 °C

*** including main system, pre-dilution and rinse valve, without bypass pump and water feed section

**** 230 V figures with bypass pump (CDVd 45-600), 115 V figures without bypass pump

***** Sodium chlorite (NaClO₂) 7.5 %, purity in accordance with EN 938, hydrochloric acid 9%, purity in accordance with EN 939. The chemical consumption may vary depending on the temperature.

Ambient conditions:

Permissible relative air humidity (non-condensing)	max. 85% rel.
Permissible ambient temperature	40 °C
Permissible temperature of chemicals	10 ... 35 °C
Storage and transport temperature	-10 ... +40 °C
Degree of protection	IP 65



1 Disinfection Systems and Oxidation Systems

Identity code ordering system for CDVd systems

CDVd	Capacity
45	CDVd 00045 = 45 g/h
120	CDVd 00120 = 120 g/h
240	CDVd 00240 = 240 g/h
600	CDVd 00600 = 600 g/h
2000	CDVd 02000 = 2,000 g/h
Design	
P	ProMinent
Bypass design:	
0	without bypass
1	Bypass PVC-U without bypass pump
2	Bypass PVC-U with bypass pump 230 V / 50 Hz
3	Bypass in USA design with ASI connections and unit in gpm, without bypass pump
4	Bypass for the secure filling of a storage module with 24 V valve and water meter, without storage module / without bypass pump (here, a hydraulic valve is placed upstream of the metering pump + a smaller flow meter)
5	Bypass 24 V for the secure filling of a storage module with 24 V valve and water meter, with 30-litre storage module, without bypass pump (here, a hydraulic valve is placed upstream of the metering pump + a smaller flow meter)
6	Bypass for the secure filling of a storage module with 24 V valve and water meter, with 150 litre storage module, without bypass pump (here, a hydraulic valve is placed upstream of the metering pump + a smaller flow meter)
Suction lance, suction assembly for chemicals	
0	none
1	Suction lance for 5 ... 60 l storage tank
2	Suction lance for 200 l storage tank
3	Flexible suction assembly up to 5 m with two-stage level switch
4	Suction lance for 25 l storage tank with two 40 l collecting pans without leak sensor
Default language	
DE	German
EN	English
FR	French
IT	Italian
ES	Spanish
SV	Swedish
FI	Finnish
Analogue input / output	
0	none
1	with input / output
2	with input / output and with level measurement for chlorite + acid
Bus communication	
0	none
1	Modbus TCP
2	Modbus RTU
3	PROFIBUS® DP
4	PROFINET
5	Modbus TCP / DULCOnneX
6	Modbus RTU / DULCOnneX
7	PROFIBUS® / DULCOnneX
8	PROFINET / DULCOnneX



1 Disinfection Systems and Oxidation Systems

Maintenance Sets for Bello Zon® CDV Chlorine Dioxide Systems

The maintenance kits contain all of the wear parts that may need to be replaced during regular system maintenance.

Maintenance kits for CDVd systems

	Order no.
Maintenance kit, complete CDVd 45	1105948
Maintenance kit, complete CDVd 120	1105949
Maintenance kit, complete CDVd 240	1105950
Maintenance kit, complete CDVd 600	1105951
Maintenance kit, complete CDVd 2000	1105952

Maintenance sets for CDVc systems

	Order no.
Maintenance set, complete CDVc 20	1034758
Maintenance set, complete CDVc 45	1034759
Maintenance set, complete CDVc 120	1034760
Maintenance set, complete CDVc 240	1034761
Maintenance set, complete CDVc 600	1034762
Maintenance kit, complete CDVc 2000 up to delivery date 03/2011	1034763
Maintenance kit, complete CDVc 2000 from delivery date 04/2011	1048801

Maintenance sets for CDVb systems

	Order no.
Maintenance set, complete CDVb 15	1022252
Maintenance set, complete CDVb 35	1022253
Maintenance set, complete CDVb 60	1022264
Maintenance set, complete CDVb 120	1022265
Maintenance set, complete CDVb 220	1024614

Maintenance sets for CDVa systems

	Order no.
Maintenance set, complete 230 V CDVa 35	791842
Maintenance set, complete 230 V CDVa 60	791913
Maintenance set, complete 230 V CDVa 120	791915
Maintenance set, complete 230 V CDVa 220	740824
Maintenance set, complete 230 V CDVa 400	740765
Maintenance set, complete 230 V CDVa 600	740826
Maintenance set, complete 230 V CDVa 2000	1005333
Maintenance set, complete 115 V CDVa 35	791860
Maintenance set, complete 115 V CDVa 60	791914
Maintenance set, complete 115 V CDVa 120	791916
Maintenance set, complete 115 V CDVa 220	740825
Maintenance set, complete 115 V CDVa 400	740819
Maintenance set, complete 115 V CDVa 600	740827
Maintenance set, complete 115 V CDVa 2000	1005344

Additional spare parts are listed in the operation instructions for the systems.



1 Disinfection Systems and Oxidation Systems

1.3.8

Chlorine dioxide system Bello Zon® CDKd

Chlorine dioxide system Bello Zon® CDKd treats medium to large volumes of water with concentrated chemicals.

15 – 12,000 g/h chlorine dioxide. The maximum volume of water that can be treated with metering of 0.2 ppm ClO_2 , depending on the size of the system: 60,000 m³/h

Chlorine dioxide system for the metering of chlorine dioxide with concentrated starting chemicals. The proven three-stage safety concept protects people and the environment. The certified output guarantees efficient chlorine dioxide production. Bello Zon® CDKd can be easily and safely integrated into any water treatment process.

There is an intrinsically safe pre-dilution station for concentrated hydrochloric acid in this chlorine dioxide system. The consumption of hydrochloric acid can therefore be automatically adapted on site to the individual operating conditions by means of a patented process. Savings of up to 20%.

The system control stands out on account of its user-friendly menu guidance and ensures the precise production of chlorine dioxide. The chemicals are mixed perfectly in a reactor made of food-safe PVDF. You thereby benefit from maximum output with the lowest possible consumption of chemicals and maximum operating safety. Communication via popular bus systems, via web server and our DULCOnneX platform fulfils all the requirements set by the Industry 4.0 standards of tomorrow.

The construction and operating mode of the system also complies with all requirements of DVGW specifications W 224 and W 624 and the system is intended for operation with concentrated chemicals Bello Zon® chlorite (24.5% NaClO_2) and acid (25 – 37% HCl). The liquid levels of the starting chemicals can either be displayed and monitored by external liquid level sensors or by patented adaptive liquid level monitoring.

Your benefits

- Cost savings through optimised acid consumption
- Various communication options via BUS, web server or DULCOnneX
- System does not stop due to empty starting feed chemical tanks, thanks to precise level indicator displays
- Ultra-simple and safe operation thanks to intuitive menu guidance
- Cost-effective operation due to the use of inexpensive, concentrated starting chemicals
- Location-independent system monitoring in real time via the DULCOnneX platform: Improved process reliability. Reliability and transparency due to real-time monitoring, individual alarms and automated reports.
- Maximum operating safety and purity of the ClO_2 produced by PVDF reactors and three-stage safety concept
- Automatic monitoring of operating parameters and maintenance intervals

Technical Details

Power supply

- 100-230 V, 50/60 Hz

Inputs

- 4 analogue inputs (0/4-20 mA)
 - Water flow
 - Control variable
 - Acid level
 - Chlorite level
- 4 digital inputs
 - Contact water meter 0.25-20 Hz
 - Pause
 - Alternative metering
 - External fault

Outputs

- 1 operating signal relay
- 1 alarm signal relay
- 1 warning signal relay
- Mains output for the control of the bypass pump
- 2 freely configurable analogue outputs (0/4-20 mA)

Operating substances

- Sodium chlorite 24.5 %, purity according to EN 938
- Hydrochloric acid 25-37 % purity according to EN 939
- Particle-free water



1 Disinfection Systems and Oxidation Systems

Degree of protection

- IP 65

Field of application

- Municipal potable water and sewage treatment
- Industrial process and cooling water

Technical Data

Type	Chlorine dioxide capacity*		Max. operating pressure**	Operating temp.	Suction-side connector dimension of calibration vessels		Dimensions of the bypass connector
	min.-max./hour g/h	min./day g/d			Chlorite	Acid	
			bar	°C			DN
CDKd 150	15–150	56	8	10–40	8x5	6x4	25
CDKd 400	40–400	140	8	10–40	12x9	8x5	25
CDKd 900	90–900	300	8	10–40	Pressure hose nozzle d16	8x5	25
CDKd 2000	200–2,000	700	5	10–40	Pressure hose nozzle d20	8x5	40
CDKd 2800	280–2,800	700	5	15–40	Pressure hose nozzle d20	8x5	40
CDKd 7300	730–7,300	1,750	3	15–40	Pressure hose nozzle d32	Pressure hose nozzle d16	40
CDKd 12000	600–12,000	1,750	2	18–40	Pressure hose nozzle d32	Pressure hose nozzle d16	40

Type	Dimensions*** H x W x D (mm)	Weight	Power consumption (max.)****		Power consumption		Chemical consumption at 100% system capacity*****	
			230 V	115 V	without bypass pump	with bypass pump	HCl (30%)	NaClO ₂ (24.5%)
	mm	kg	A	A	W	W	l/h	l/h
CDKd 150	1,300 x 1,000 x 250	89	3.9	1.7	110	640	0.9	0.9
CDKd 400	1,675 x 900 x 460	119	3.9	1.8	160	690	2.5	2.5
CDKd 900	1,920 x 920 x 520	131	4.2	2.3	210	740	5.6	5.6
CDKd 2000	1,880 x 1,320 x 570	201	–	3.7	370	–	12.3	12.3
CDKd 2800	1,880 x 1,320 x 570	201	–	3.7	370	–	17.3	17.3
CDKd 7300	2,250 x 1,850 x 500	216	–	8.6	610	–	45.1	45.1
CDKd 12000	2,250 x 1,850 x 500	216	–	8.6	610	–	74.1	74.1
HCl pre-dilution	1,180 x 900 x 140		–	–	–	–	–	–

* The metering figures relate to 5 or 2 bar back pressure and an ambient temperature of 20 °C. The minimum capacity/per hour is based on the fact that when the plant is operating at below 5% of the nominal power, continuous metering is no longer possible due to the then low pumping frequency of the metering pumps. The reactor contents should be changed at least twice daily with systems that do not work continuously. Therefore do not operate the system below the stated minimum capacity/day.

** at an ambient temperature of 35 °C

*** including main system, pre-dilution and rinse valve, without bypass pump and water feed section

**** 230 V figures with bypass pump (CDKd 150-900), 115 V figures without bypass pump

***** Sodium chlorite (NaClO₂) 24.5 %, purity in accordance with EN 938, hydrochloric acid 25-36%, purity in accordance with EN 939. The chemical consumption may vary depending on the temperature. The hydrochloric acid consumption is calculated for a concentration of 30%. Up to 25% hydrochloric acid can be saved with the aid of automatic acid adjustment.

Ambient conditions:

Permissible relative air humidity (non-condensing)	max. 85% rel.
Permissible ambient temperature	40 °C
Permissible temperature of chemicals	10 ... 35 °C
Storage and transport temperature	-10 ... +40 °C
Degree of protection	IP 65



1 Disinfection Systems and Oxidation Systems

Identity code ordering system for CDKd systems

CDKd	Capacity
150	CDVd 00150 = 150 g/h
400	CDVd 00400 = 400 g/h
900	CDVd 00900 = 900 g/h
2000	CDVd 02000 = 2,000 g/h
2800	CDVd 02800 = 2,800 g/h
7300	CDVd 07300 = 7,300 g/h
12000	CDVd 12000 = 12,000 g/h
Design	
P	ProMinent
Bypass design:	
0	without bypass
1	Bypass PVC-U without bypass pump
2	Bypass PVC-U with bypass pump 230 V / 50 Hz
4	Bypass for the secure filling of a storage module with 24 V valve and water meter, without storage module / without bypass pump (here, a hydraulic valve is placed upstream of the metering pump + a smaller flow meter)
5	Bypass 24 V for the secure filling of a storage module with 24 V valve and water meter, with 30 litre storage module, without bypass pump (here, a hydraulic valve is placed upstream of the metering pump + a smaller flow meter)
6	Bypass for the secure filling of a storage module with 24 V valve and water meter, with 150 litre storage module, without bypass pump (here, a hydraulic valve is placed upstream of the metering pump + a smaller flow meter)
Suction lance, suction assembly for chemicals	
0	none, Local Unit, LAN, Compact and Global Unit
2	Variable suction lance for 200 l storage tank, gas-tight, with a second acid lock (storage tank height 500 ... 700 mm)
3	Flexible suction assembly up to 5 m for IBC storage tanks with two-stage level switch, with a second acid lock
Default language	
DE	German
EN	English
FR	French
IT	Italian
ES	Spanish
SV	Swedish
FI	Finnish
Analogue level measurement	
0	none
1	with input / output
2	with input / output and with level measurement for chlorite + acid
3	with input / output, including adaptive acid adjustment (Pt 1000)
4	with input / output and with level measurement for chlorite + acid, including adaptive acid adjustment (Pt 1000)
Bus communication	
0	none
1	Modbus TCP
2	Modbus RTU
3	PROFIBUS®
4	PROFINET
5	Modbus TCP / DULCOnneX
6	Modbus RTU / DULCOnneX
7	PROFIBUS® / DULCOnneX
8	PROFINET / DULCOnneX



1 Disinfection Systems and Oxidation Systems

Maintenance kits for Bello Zon® chlorine dioxide systems type CDKd

The spare parts kits include all wearing parts that need replacing in the course of regular maintenance.

	Order no.
Maintenance kit, complete CDKd 150	1105953
Maintenance kit, complete CDKd 400	1105954
Maintenance kit, complete CDKd 900	1105955
Maintenance kit, complete CDKd 2000	1105956
Maintenance kit, complete CDKd 2800	1105957
Maintenance kit, complete CDKd 7300	1105958
Maintenance kit, complete CDKd 12000	1105959

Additional spare parts are listed in the operating instructions for the systems.

Maintenance kits for Bello Zon® chlorine dioxide systems type CDKc

The spare parts kits include all wearing parts that need replacing in the course of regular maintenance.

	Order no.
Maintenance kit, complete CDKc 150 (type 20)	1043841
Maintenance kit, complete CDKc 170 (type 02)	1036454
Maintenance kit, complete CDKc 400 (type 21)	1043842
Maintenance kit, complete CDKc 420 (type 04)	1036455
Maintenance kit, complete CDKc 900 (type 22)	1043843
Maintenance kit, complete CDKc 900 (type 06)	1036456
Maintenance kit, complete CDKc 2000 (type 23)	1043864
Maintenance kit, complete CDKc 2100 (type 08)	1036457
Maintenance kit, complete CDKc 2800 (type 24)	1043865
Maintenance kit, complete CDKc 3000 (type 10)	1036458
Maintenance kit, complete CDKc 7500 (type 25)	1043866
Maintenance kit, complete CDKc 7500 (type 12)	1036459
Maintenance kit, complete CDKc 12000 (type 26)	1043867
Maintenance kit, complete CDKc 12000 (type 14)	1040079

Additional spare parts are listed in the operating instructions for the systems.

Maintenance kits for Bello Zon® chlorine dioxide systems type CDKa

The spare parts kits include all wearing parts that need replacing in the course of regular maintenance.

	Order no.
Maintenance kit, complete 230 V CDKa 150	740740
Maintenance kit, complete 230 V CDKa 420	740743
Maintenance kit, complete 230 V CDKa 750	1000172
Maintenance kit, complete 230 V CDKa 1500	1000856
Maintenance kit, complete 230 V CDKa 6000	1004814
Maintenance kit, complete 230 V CDKa 10000	1006647
Maintenance kit, complete 115 V CDKa 150	740741
Maintenance kit, complete 115 V CDKa 420	740744
Maintenance kit, complete 115 V CDKa 750	1000173
Maintenance kit, complete 115 V CDKa 1500	1000855
Maintenance kit, complete 115 V CDKa 6000	1004815

Additional spare parts are listed in the operating instructions for the systems.



1 Disinfection Systems and Oxidation Systems

1.3.9 Storage Tank Accessories

1

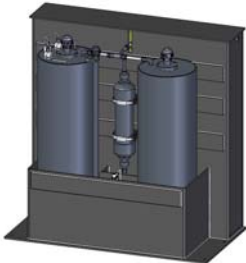

04_VM_150L



06_VM_150L

External storage module CDVd/CDKd

The large chlorine dioxide storage module with integrated volume compensation bag

Useful capacity 150 l

The external storage module features a volume compensation bag so that no external bleed line or neutralisation of the chlorine dioxide gas volume is needed.

The maximum permissible concentration of the ClO₂ solution is 2,000 mg/l.

Your benefits

The storage module can be connected on a project basis to the chlorine dioxide systems BelloZon® CDVc and CDKc. Make sure that the defined safety equipment (secure bypass) is also installed. Please contact our Sales Department with any project enquiries.

Field of application

The external storage module can be used in applications where more than one point of injection is needed and where a capacity of more than 120 g ClO₂ per hour is needed.

	Dimensions L x W x H (mm)	Connectors. Extraction	Filling	Order no.
Storage module 150 l for BelloZon®	1,300 x 685 x 1,290	2 x DN 32	1 x DN 25	1060153



1 Disinfection Systems and Oxidation Systems

1.3.10 Bypass Line Accessories

Premixers Made of PVC

CDVb 15-120 premixers are fully integrated in the plant, provided they are ordered with the Identity Code. The premixer on the CDVb 220 can also be ordered by Identity Code but is supplied loose with the plant. On all other plants, the premixer can be ordered partly by Identity Code or partly as a separate order. The standard delivery package of the premixer includes all PVC couplings, screw hose clips and other fixing materials. On the CDVa 2000 and CDKa 1500–10000, the pre-mixer is in two parts.

Plant	Volume	Length	Connection nominal diameter	Order no.
	l	mm		
CDVb 220, CDKa 150	1.5	594	DN 25	740649
CDVa 400, CDKa 420	4.5	756	DN 25	740650
CDVa 600, CDKa 750	7.0	1,306	DN 32	740832
CDVa 2000, CDKa 1500	13.4	2x1,316	DN 40	1001000
CDKa 6000/10000	13.4	2x1,330	DN 50	1003121

Bypass Pump

Booster pumps made of cast iron (GG) or stainless steel (SS) for operation in the bypass line. Electrical version 220-230 V, 50 Hz, with integrated overload protection.

The required bypass flow should be considered when selecting a suitable bypass pump. The following flow data is recommended for the different plants:

Plant type	Bypass line	Diameter (mm)	Flow rate (m ³ /h)
CDV 15 – 600	DN 25	32	0.5 - 2
CDV 2,000	DN 40	50	2 - 10
CDKa 150 – 420	DN 25	32	0.5 - 2
CDKa 750	DN 32	40	1 - 3.5
CDKa 1,500	DN 40	50	1.5 - 10
CDKa 6,000 – 10,000	DN 50	63	6 - 10
CDKc 150 - 900	DN 25	32	0.5 - 2
CDKc 2,000 - 2,800	DN 40	50	2 - 10
CDKc 7,300	DN 40	50	6 - 10
CDKc 12,000	DN 40	50	10 - 15

PVC should be used as the material for the bypass. The thickness should at least correspond to the pressure range PN 10, or even better PN 16 (bar).

Type	Material	Connection suction/discharge side	Pump capacity at 2 bar	Nomina l rating	Nominal current	Order no.
			m ³ /h	W	A	
ZHM 3	SS	RP 1"/1"	1.2	500	2.3	1051081

Caution: Do not allow pump to come into contact with ClO₂!

Accessories

	Order no.
Bracket for bypass pump	791474
Angle-seat valve PVC DN 25 for throttling the bypass pump	1001877



1 Disinfection Systems and Oxidation Systems

1

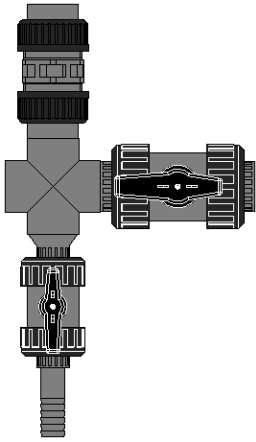

P_PMA_AC_0257_SW
Flushing assembly

Flushing Assembly

Install a flushing valve downstream of the chlorine dioxide system so that the reactor and pre-mixer can be flushed through, either for maintenance purposes or after a long system shut-down. The complete flushing equipment kit comprises a DN 20 or DN 25 PVC stopcock and a DN 15 PVC flushing valve with a hose nozzle and a DN 25 vacuum relief valve. It is already included as standard in the scope of supply of all new systems.

	Order no.
Flushing equipment PVC-U, EPDM, DN 20 for CDE	1047718
Flushing equipment PVC-U, EPDM, DN 25 for CDV, CDK	1033405

Bypass Pressure Gauge CDVc/CDKc

The fitting is used during commissioning to adjust the water pressure in the bypass. It is connected to the flushing valve on the flushing assembly for this purpose. The pressure measurement bypass consists of a PVC stopcock DN 15 and a diaphragm seal with manometer.

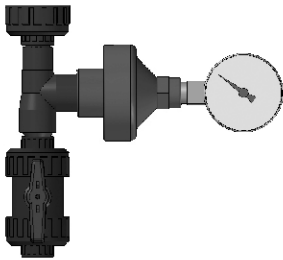

P_PMA_AC_0258_SW1

	Order no.
Bypass pressure measurement DN 20 for CDE, CDVc, CDKc	1050092

Ball-check Valve

A back pressure-resistant ball-check valve should be fitted on installations with long bypass lines, especially if the pipe slopes downwards and the point of injection is below the Bello Zon® system, as well as on installations with fluctuating back pressure.

Type	Nominal diameter	Connector	Material	Order no.
DHV-U	DN 20	G 1 1/4"	PCB	1037775
DHV-U	DN 25	G 1 1/2"	PCB	1037774
DHV 712-R	DN 40	G 2 1/4"	PCB	1000052



1 Disinfection Systems and Oxidation Systems

PVC-U Chlorine Dioxide Point of Injection

Use an immersion pipe for homogeneous distribution of the chlorine dioxide enriched bypass water in the main water supply pipe, to optimise the mixing and distribution of the chlorine dioxide. Shorten the immersion pipe on site to the required length. The scope of delivery includes a ball valve DN 25 as a shut-off valve for this purpose. The immersion pipe is installed using a DN 50 DIN flange supplied by others.

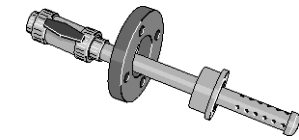

pk_7_011_2
Injection pipe from DN 100

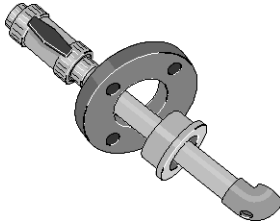

pk_7_012_2
Injection pipe to DN 80

	Order no.
Injection pipe for pipe diameters up to DN 80	1018754
Injection pipe for pipe diameters from DN 100	1018753

Inductive Magnetic Flow Meters

The flow meter with transducer MAG 5100 W is especially suitable for water flow measurement in the fields of ground water, potable water, waste water and sludge.

	Connection nominal diameter DIN / ANSI	Order no.
Inductive magnetic flow meters	DN 25	1048775
	DN 50	1034685
	DN 65	1034686
	DN 80	1034687
	DN 100	1034688



1 Disinfection Systems and Oxidation Systems

1.3.11 Chemical Supply Accessories

Suction Lances and Accessories

Suction lances have a rigid construction that can be precisely adapted to the chemical tank. Suction assemblies consist of flexible suction lines.

All suction lances and suction assemblies are made of PVC with FKM seals and are fitted with a foot valve and two-stage level switch including cable and round plug. Select relevant components from the ProMinent motor-driven metering pump accessories range for system types not listed here.

	Suitable for system types	Order no.
Suction lance for connection to 5-60 litre non-reusable tank with 2 m long suction hose (6/4 mm)	CDVc 20-120, CDE 45-80	802077
Suction lance for connection to 5-60 litre non-reusable tank with 2 m long suction hose (6/4 mm)	CDLb	790650
Suction lance for connection to 5-60 litre non-reusable tank with 2 m long suction hose (8/5 mm)	CDVc 240-600, CDE 140	802078
Suction lance for connection to 200 litre drums with 3 m long suction hose (6/4 mm)	CDVc 20-120, CDE 45-80	802079
Suction lance for connection to 200 litre drums with 3 m long suction hose (6/4 mm)	CDLb	791563
Suction lance for connection to 200 litre drums with 3 m long suction hose (8/5 mm)	CDVc 240-600, CDE 140	802080
Flexible suction fitting with D55 screw cap and 5 m suction hose (6/4mm)	CDVc 20-120, CDE 45-80	1034602
Flexible suction fitting with D55 screw cap and 5 m suction hose (8/5 mm)	CDVc 240-600, CDE 140	1034644
Suction lance DN 25 PP for connection to 200 litre drums, excluding cable	CDVc 2000	1039397
Suction lance DN 25 PP for connection to 1,000 litre IBC container, excluding cable	CDVc 2000	1039399
Gas-tight suction lance for 200 litre drums with bleed valve, connection for 6/4 and 8/5 mm suction lines and connector for 6/4 mm return line	CDKc 150-2800	1036371
Gas-tight suction lance for 60-litre canister with bleed valve, connector for 6/4 and 8/5 mm suction line and connector for 6/4 mm return line	CDKc 150-2800	1030891
Flexible suction assembly with 5 m suction hose (6/4 mm) and gas-tight D55 screw cap with opening for a return line	CDKc 150-2800	1036174
Flexible suction assembly with 5 m suction hose (8/5 mm) and gas-tight D55 screw cap with opening for a return line	CDKc 150-2800	1036175

Safety Collecting Pans for Chemical Tanks

Usable capacity	Type	Order no.
40	Without leakage monitor	791726
40	With leakage monitor	791728
70	Without leakage monitor	740309
70	With leakage monitor	740308
140	Without leakage monitor	740723
140	With leakage monitor	1003190

Scope of delivery:

- Without leakage monitor: one pan
- With leakage monitor: two pans + level switch + electronics card for Bello Zon®control (CDVa, CDVb, CDKa)

1 Disinfection Systems and Oxidation Systems



pk_1_126

Extension cable, 3-core

For 2-stage level switches, with round plug and round plug coupling.

	Cable length m	Fig.	Order no.
Extension cable, 3-core	3	pk_1_126	1005559

Calibration Free-standing Cylinder for Bello Zon® CDEa

	Order no.
Measuring cylinder, tall, 500 ml PP	790661

Leakage Monitor for CDVc and CDKc Systems

	Order no.
Level switch with litz wire 5 m	1003191

Consisting of 1 level switch to be fitted in the 40, 70 or 140 l safety drip pans without leakage monitor and connected to the control of the Bello Zon® CDVc and CDKc.

Drip Pan with Grating to Install Two 200 l Barrels

Material	Weight kg	External dimension WxDxH mm	Effective area WxD mm	Collecting volume l
Polyethylene	ca. 22	1,230 x 820 x 435	1,160 x 750	220

Meets the requirements of the German Water Resources Act (WHG) and possesses a general building supervision approval from DIBt, Berlin.

	Order no.
Drip pan with grating	1027211

Bello Zon® Acid

Component 1 for Bello Zon® chlorine dioxide production system.

	Order no.
Bello Zon® Acid 25 l	1027594
Bello Zon® Acid 200 l	950131

Bello Zon® Chlorite

Component 2 for Bello Zon® chlorine dioxide production system.

	Order no.
Bello Zon® Chlorite 10 l	1026422
Bello Zon® Chlorite 25 l	1027595
Bello Zon® Chlorite 200 l	950136



1 Disinfection Systems and Oxidation Systems

1.3.12 Safety Accessories and Analysis

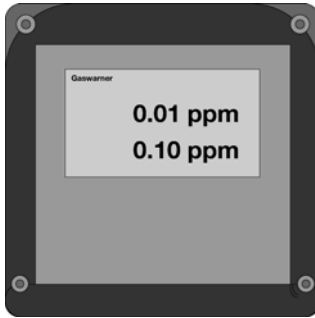

P_DV_0030_SW

Gas detector Neon® Gas Chlorine Dioxide

The gas detector type Neon® Gas Chlorine Dioxide is designed as a compact measuring and switching unit for monitoring the ambient air for dangerous concentrations of chlorine dioxide.

Type	Chlorine dioxide
Warning at approx.	0.2 ppm/vol%
Alarm at approx.	1.0 ppm/vol%
Permissible ambient temperature	0...50°C
Protection class housing	IP 65
Dimensions (without PGs, without sensor) H x W x D	144 x 144 x 156 mm
Supply	85 – 265 / 50 – 60 V/Hz
Power consumption	10 W
Warm-up phase max.	150 s
"Warning" relay contact, self-resetting	250 V ; 6 A
"Alarm" relay contact, latching	250 V ; 6 A
"Horn" relay contact, latching, can be acknowledged	250 V ; 6 A
Sensor measuring principle	Electrochemical
Sensor service life (depending on ambient conditions)	1 years

Note: The sensor responds to all oxidising gases

	Order no.
Gas detector Neon® Gas including gas sensor bracket, 10 m connecting cable for 1 gas sensor for ClO₂, 230 V	1083161
Gas detector Neon® gas including gas sensor bracket, 10 m connecting cable and 1 gas sensor for ClO₂, 24 VDC	1093886

Accessories for connecting an additional sensor

	Order no.
Gas sensor support	1082466
Connecting cable 5x0.25 mm² 10 m	1082467
Chlorine dioxide sensor 5 ppm*	1104353

* Storage sensor at 4 °C... 10 °C



Flash light-horn

Combined horn and red warning lamp. IP 65 housing made of impact-resistant grey polycarbonate with a transparent polycarbonate dome. Rating values: 230 V AC, 50 mA.

	Order no.
Flash light-horn, red with continuous tone	1083160

Warning Label for Chlorine Dioxide System

Soft PVC film, yellow/black, 300 x 200 mm, self-adhesive.

Text	Language	Order no.
"Behälter und Geräte nicht wechselweise benutzen"	German	607320
"Never mix up chemical containers"	English	607318
"Non usare serbatoi e apparecchi alternativamente"	Italian	791886



1 Disinfection Systems and Oxidation Systems

Warning Label for Chlorine Dioxide Room

PVC film yellow/black, 200 x 80 mm

Text	Language	Order no.
"Zutritt nur für unterwiesene Personen"	German	607322
"Entry for authorised persons only"	English	607319
"Vietato l'accesso ai non addetti ai lavori"	Italian	791885

Acid Fume Separator

Acid vapour separator, filled with acid-binding granules for the absorption of hydrochloric acid vapours.

	Order no.
Acid vapour separator CDKa 0.7 l	1009987
Acid vapour separator CDKc 0.13 l	1034692
Spare back of binder 0.15 l CDKc	1035854
Spare back of binder 0.7 l CDKa	1010500

Photometers DT1, DT2 and DT4

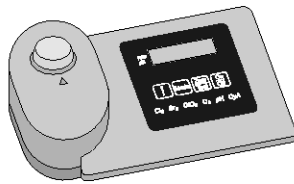

P_DT_0074_SW
Photometer

- Portable, compact photometer
- Simple operation with text support
- Safe, simple measurement of chlorine, chlorine dioxide, fluoride, chlorite, H₂O₂, bromine, ozone, pH and cyanuric acid
- Calibratable

Measuring ranges of the DT1B	0.05 ... 6.0 mg/l free chlorine (DPD1) +total chlorine (DPD1+3) 5 ... 200 mg/l free chlorine (high range) 0.1 ... 13.0 mg/l bromine (DPD1) 0.05 ... 11 mg/l chlorine dioxide (DPD1) 0.03 ... 4.0 mg/l ozone (DPD4) 6.5 ... 8.4 pH (phenol red) 1 ... 80 mg/l cyanuric acid
Measuring ranges of the DT2C	0.05 ... 2.0 mg/l fluoride 0.05 ... 6.0 mg/l free chlorine and total chlorine 0.05 ... 11.0 mg/l chlorine dioxide
DT4 ranges	0.03 ... 2.5 mg/l chlorite 0.05 ... 11 mg/l chlorine dioxide 0.05 ... 6 mg/l chlorine
Measuring tolerance	Dependent upon measured value and measuring method
Battery	4 AA/LR6 batteries
Permissible ambient temperature	5...40 °C
Relative humidity	30 ... 90% (non-condensing)
Material	Housing material: ABS Keypad: Polycarbonate
Dimensions L x W x H (mm)	190 x 110 x 55
Weight	0.4 kg

		Order no.
Photometer DT1B	Complete with carrying case	1039315
Photometer DT2C	Complete with carrying case	1039316
Photometer DT4B	Complete with carrying case	1039318

The standard delivery package for the photometers includes accessories, cuvettes and reagents



1 Disinfection Systems and Oxidation Systems

Case for Chlorine Dioxide Depletion Test

The case contains the equipment needed for a ClO₂ depletion test. A photometer and the starting chemicals are also needed.

Important: Only allow trained personnel to use the case!

	Order no.
Measuring case	1042890

Consumables for Analysis

	Order no.
DPD1 tablets, 100 pieces *	1061892
DPD3 tablets, 100 pieces **	1061893
Glycine tablets, 20 pieces	1061944
Phenol red tablets 100 pieces	305532
Cyanuric acid tablets, 100 no.	1039744
SPADNS reagent, 250 ml for fluoride detection	1010381
Calibration standard fluoride 1 mg/l, for calibration of the photometer during fluoride determination	1010382
3 pieces replacement cuvettes; round cuvettes with lid for DPD, phenol red and cyanuric acid detection (DT1, DT1B, DT4, DT4B, DT2B, DT2C)	1007566
3 pieces replacement cuvettes for fluoride detection (DT2B and DT2C)	1010396
Chlorine dioxide tablets No. 1, 250 no.	1039732
Chlorine dioxide tablets No. 2, 250 no.	1039733
Chlorine HR tablets, 100 pieces	1075056
Acidifying tablets, 100 pieces	1075057

* replaces DPD1 buffer, 15 ml (1002857) and DPD1 reagent, 15 ml (1002858)

** replaces DPD3 solution, 15 ml (1002859)

DPD reagents for measurement of excess chlorine, ozone or chlorine dioxide in the water, in conjunction with a Lovibond comparator.

	Amount	Order no.
DPD tablets no. 1	100	501319
DPD tablets no. 2	100	501320
DPD tablets no. 3	100	501321
DPD tablets no. 4	100	501322



1 Disinfection Systems and Oxidation Systems

1.3.13

DULCOneX – digital fluid management



Location-independent system monitoring in real time

You always have all the key data and measured values in sight at all times with DULCOneX. Monitor and document the status of your system in real time. Check your unit data, regardless of where you are, safely and reliably when you're out and about. Simply use the terminal device of your choice: smartphone, tablet or PC.

Refer to our catalogue or website for more information and references.



1



1 Disinfection Systems and Oxidation Systems

1.4 Electrolysis Systems CHLORINSITU® and DULCO®Lyse

1.4.1 Electrolysis Systems CHLORINSITU®

In electrolysis, chlorine and sodium hydroxide solution are produced in situ from salt water using electric current.

In **open electrolysis cell** (type CHLORINSITU® IIa) the electrochemical reaction takes place in a flow chamber, so that the freshly produced chlorine gas immediately reacts with the sodium hydroxide solution also produced to form sodium hypochlorite. A saturated brine is used as a salt solution, which is produced in a separate salt dissolving tank from salt of a defined quality. The benefit of the open electrolysis cell lies in the simple construction of the equipment, its ease of maintenance and low investment compared to **membrane electrolysis systems**. The disadvantage is the low output of the salt solution, higher entrainment of chloride into the water to be treated, higher power consumption and low chlorine concentrations in the end product.

In **membrane electrolysis** the electrochemical reaction takes place in two electrode chambers, separated by a diaphragm, so that the formation of the freshly produced chlorine gas and sodium hydroxide solution is physically separated. Systems of type CHLORINSITU® III and CHLORINSITU® III Compact bring the reaction mixtures of both electrode chambers together again after the electrochemical reaction to produce a stock solution of sodium hypochlorite (25 g/l FAC), which can be stored temporarily and metered as needed.

With systems of type CHLORINSITU® IV Compact and CHLORINSITU® V, the highly pure chlorine gas is fed into the water to be treated through an injector and under constant vacuum, where it dissolves as hypochlorous acid. In systems of type CHLORINSITU® V Plus, any excess chlorine gas produced is combined with the sodium hydroxide solution, as in the CHLORINSITU® III system, to form sodium hypochlorite and is then stored temporarily. The systems therefore only need to be designed for average chlorine demand, as peaks of capacity can be compensated for from the sodium hypochlorite temporary storage tank. In all systems of type CHLORINSITU® IV Compact, CHLORINSITU® V and CHLORINSITU® V Plus, the sodium hydroxide solution produced during electrolysis is stored temporarily and metered in, as required, to correct the pH value.

The benefit of membrane systems lies in their excellent efficiency (85 % brine output) and minimal entrainment of chloride compared to open electrolysis cells. With systems of type CHLORINSITU® V and CHLORINSITU® V Plus, the entrainment of chloride and chlorate from the electrolysis cell into the water to be treated can be avoided completely. In diaphragm cell electrolysis systems for producing sodium hypochlorite, the higher output results in solutions with a significantly higher chlorine content than is the case with open electrolysis cells.

- Disinfection from natural sodium chloride
- No handling of hazardous chemicals
- High-purity product, thanks to production in situ and short temporary storage periods
- The chlorine gas is generated under a constant vacuum, absolutely reliably and with maximum operating safety, thanks to the units being designed as vacuum systems
- Chlorine generation and pH correction with one system (CHLORINSITU® IV Compact, CHLORINSITU® V and CHLORINSITU® V Plus)
- Improved working conditions for operating personnel
- No risk of confusing dangerous chemical tanks



1 Disinfection Systems and Oxidation Systems

1.4.2 Performance Overview

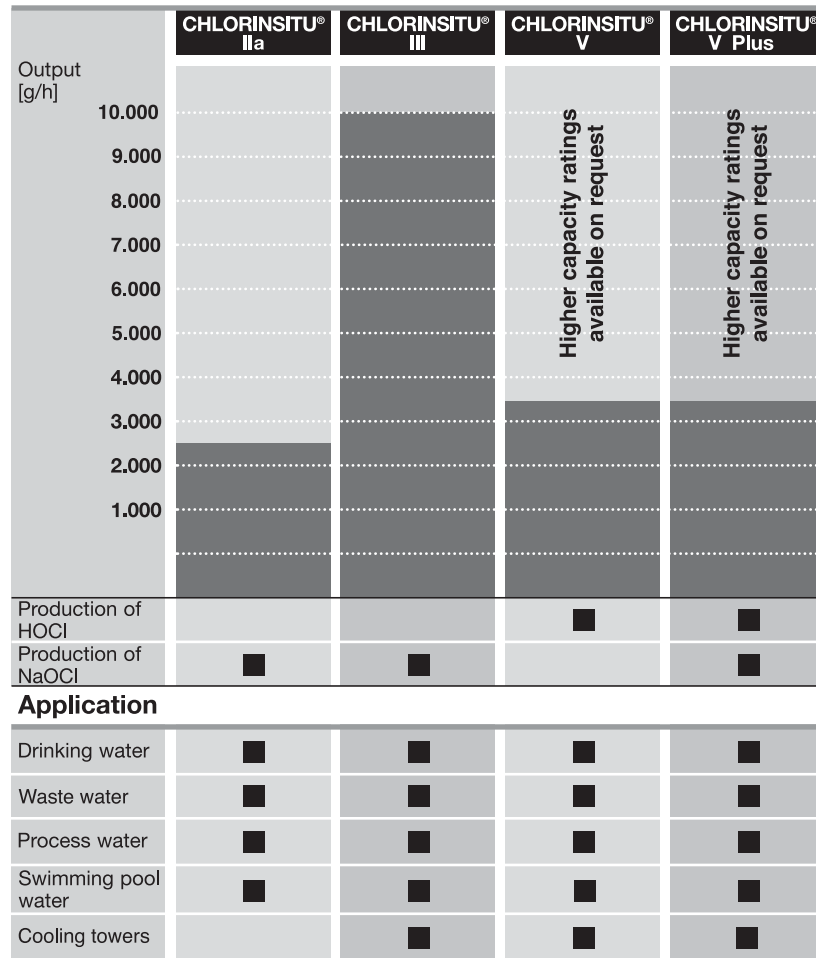

P_PMA_EL_0046_SW

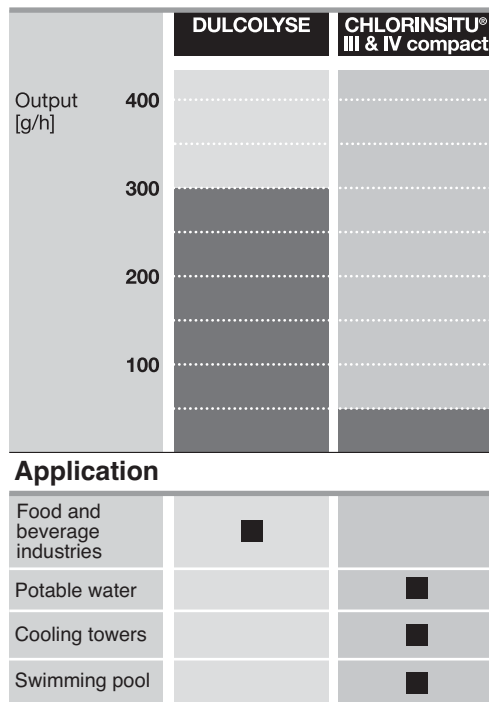

P_PMA_EL_0047_SW

Note: larger systems available on request



1 Disinfection Systems and Oxidation Systems

1.4.3 Questionnaire on the Design of an Electrolysis System

Use of the electrolysis system:

- For the disinfection of
 - Potable water
 - Industrial water
 - Cooling water
 - Swimming pool water
 - _____

Water values:

Max. water flow	_____ m ³ /h	Maximum water pressure	_____ bar
Water flow	<input type="checkbox"/> constant	<input type="checkbox"/> fluctuating from _____ m ³ /h to _____ m ³ /h	
pH value	_____	Iron (Fe ²⁺)	_____ mg/l
Temperature	_____ °C	Manganese (Mn ²⁺)	_____ mg/l
Solids proportion	_____ mg/l	Nitrite (NO ₂ ⁻)	_____ mg/l
Acid capacity K _{S4,3}	_____ mmol/l	Sulphide (S ²⁻)	_____ mg/l
Total hardness	_____ mmol/l	TOC (total organic carbon)	_____ mg/l
Total hardness	_____ °dH	Ammonium	_____ mg/l

Number of points of injection: _____

Type of metering:

- constant
- flow-proportional
- measured value-dependent

Required feed volume: _____ mg/l

Existing disinfection method:

Existing disinfection consumption: _____ kg/week

Other requirements:



1 Disinfection Systems and Oxidation Systems

1.4.4 Electrolysis system CHLORINSITU® IIa 60 – 2,500 g/h

Electrolysis system CHLORINSITU® IIa with open cell electrolysis: improved efficiency through innovative design.

Output 60 – 2,500 g/h of chlorine

CHLORINSITU® IIa is a compact on-site electrolysis system for the production of a low-chlorate hypochlorite solution from sodium chloride and electrical energy. A key advantage is its simple process management and excellent system safety through integral ventilation and bleeding.



CHLORINSITU IIa



NEW

The CHLORINSITU® IIa product range combines the proven and durable design of the undivided electrolysis cell with an innovative design. An exceptional quality of hypochlorite solution is achieved when the salt and power output is increased. The chlorate content of the product is significantly below the limit value specified in EN 901.

The electrolysis system is perfectly equipped for all safe water disinfection with an increased capacity of up to 2,500 g of chlorine per hour.

All relevant system components are accommodated in a space-saving housing. Integral hydrogen drainage enables the system to be installed without any need for additional ventilation requirements at the installation site.

The softener and a 50-litre product storage tank are installed in the system housing with systems up to 300 g/h. An integral metering pump circulates the chlorine from the storage tank directly to the application or into a larger storage tank.

An H₂ deaerator dissolves the hydrogen directly from the hypochlorite with systems above 625 g/h. The hydrogen-free product is pumped by an integral pump into an external product storage tank. The product pump is also capable of pumping along height differences of up to 7 m. Customised metering stations supply the points of injection.

The external product storage tank does not require additional hydrogen bleeding. There are therefore no additional costs relating to installation and operation.

The system is immediately ready for use, thanks to its plug-and-play concept. Operation of the electrolysis system has been consciously kept simple.

Your benefits

- durable design, reliable technology
- low-chlorate product (below the EN 901 limit value)
- high output: only 3.0 kg of salt per kg of chlorine
- reduced energy requirement: only 4 kWh/kg chlorine
- no need for an additional fan for the product storage tank
- minimal maintenance work and ease of operation

Technical Details

- efficient undivided electrolytic cell
- corrosion-proof housing with integrated ventilation fan
- Control with multicoloured touch panel
- optional remote maintenance module
- salt dissolving storage tank included in the scope of delivery
- integrated 50-litre product storage tank with optional diaphragm metering pump for the metering of the chlorine solution (up to 300 g/h)
- integrated softener (up to 300 g/h)

Field of application

- Potable water
- Swimming pool water
- Process water



1 Disinfection Systems and Oxidation Systems

Technical Data

Power supply (60 – 300 g/h): 230 VAC ±10 %, 50/60 Hz
 Power supply (625 – 2,500 g/h): 3 x 230/400 VAC ±10 %, 50 Hz

Capacity (as Cl ₂ equivalent)		Number of electrolysis cells	Fuse A	Product volume l/h	Power uptake kW	Max. salt consumption kg/h	Dimensions H x W x D mm	Salt dissolving tank l
g/h	kg/d							
60	1.4	1	C16	7	0.5	0.19	1,700 x 750 x 620	200
120	2.8	2	C16	14	0.8	0.38	1,700 x 750 x 620	200
180	4.2	3	C16	21	1.1	0.57	1,700 x 750 x 620	200
240	5.6	4	C16	28	1.4	0.75	1,700 x 750 x 620	200
300	7	5	C16	35	1.7	0.95	1,700 x 750 x 620	200
625	15	1	3 x 25	75	3.4	1.9	1,700 x 1,850 x 620	200
1,250	30	2	3 x 25	150	6.8	3.8	1,700 x 1,850 x 620	380
2,500	60	1	3 x 40	300	12.8	7.5	1,700 x 1,850 x 620	520

All figures apply for 20 °C ambient temperature and 15 °C feed water. The performance of the system is affected by the temperature and quality of the water and salt.

Salt usage: 3.0 kg/kg chlorine
Energy efficiency: 4.0 kWh/kg chlorine
Product concentration: 9 g/l (0.9 % ±0.05) chlorine
pH value of product (approx.): 9.5
Salt specifications: CHLORINSITU® salt, salt tablets or salt with a grain size of ≥ 6 mm, min. 99.4 % NaCl, max. 0.05 % insoluble substances, max. 10 mg/kg iron, max. 10 mg/kg manganese, max. 100 mg/kg calcium + magnesium
Inlet water temperature: 15...25 °C (lower/higher temperatures require a heater/chiller)
Water supply: 2 bar < pressure < 6 bar (potable water quality)
Ambient conditions: Non-condensing, non-corrosive and dust-free ambient air in the installation room
Permissible relative air humidity: max. 85 %
Permissible ambient temperature: 10...40 °C



1 Disinfection Systems and Oxidation Systems

Identity Code Ordering System for Electrolysis Systems CHLORINSITU® IIa

CIIa	Type	Capacity
		g/h
	0060	60
	0120	120
	0180	180
	0240	240
	0300	300
	0625	625
	1250	1250
	2500	2500
Design		
	P	ProMinent
	S	Non-standard
Mechanical design		
	0	Standard
	M	modified
Electrical connection		
	0	230 V, 50/60 Hz / 3x 230/400 V; 50 Hz (625 – 2,500 g/h)
Softener		
	0	none
	1	with
Chlorine pump		
	0	none
	1	with (60 – 300 g/h)
Communication interfaces		
	0	none
	1	Remote Engineer (60 – 300 g/h)
	2	Communication package (625 – 2,500 g/h)
Additional options		
	0	None
	1	with digital liquid level sensors for product tank (625 – 2,500 g/h)
	2	with ultrasound liquid level sensor for product tank (625 – 2,500 g/h)
Pre-set language		
	DE	German
	EN	English
	FR	French
	ES	Spanish
	IT	Italian

Maintenance sets for CHLORINSITU® IIa

	Order no.
Maintenance set 1-year 60 g/h	1097435
Maintenance set 1-year 120 g/h	1097436
Maintenance set 1-year 180 g/h	1097437
Maintenance set 1-year 240 g/h	1097438
Maintenance set 1-year 300 g/h	1097439
Maintenance set 3-years 60 g/h	1097440
Maintenance set 3-years 120 g/h	1097441
Maintenance set 3-years 180 g/h	1097442
Maintenance set 3-years 240 g/h	1097443
Maintenance set 3-years 300 g/h	1097455

Spare parts for CHLORINSITU® IIa

	Order no.
Electrolysis cell CIIa 60 g/h	1098825



1 Disinfection Systems and Oxidation Systems

1.4.5

Electrolysis system CHLORINSITU® IIa XL

High-performance tubular cell electrolysis

Output 5 – 45 kg/h of chlorine

CHLORINSITU® IIa XL is the recently developed tubular cell electrolysis system for in situ production of large quantities of hypochlorite. It is convincing with its ease of operation and outstanding efficiency combined with optimum process stability for the reliable disinfection of large volumetric flows.

The new CHLORINSITU® IIa XL is specially developed to meet the requirements of large-capacity in situ potable water disinfection. Based on the recently developed tubular cells, the system is a modular system for the safe production of hypochlorite solution from a diluted salt solution. Thanks to its precise production and optimised cell design, it achieves a high turnover of salt at a concentration of 8 g/l in the final product. The certified safety concept ensures the safe extraction of hydrogen and maximum operating safety. The CIIa XL is combined with the necessary modules, depending on the needs of the project, and is adapted as best as possible to the conditions on site.

Your benefits

- Sole use of salt as the raw material
- Very long service lives due to minimal maintenance and robust technology
- Proven cell design with increased efficiency, only 3.2 kg NaCl/kg free chlorine
- Modular design
- Easy accessibility
- Certified safety
- Safe and reliable hydrogen discharge

Technical Details

Modular electrolysis systems with additional project-based components:

- Softener
- Salt dissolving and supply equipment
- Pre-dilution unit
- Cooling unit to lower the temperature in the feed water
- Rectifier
- Process control
- Product storage tank
- Metering stations

Field of application

- Potable water treatment
- Cooling water treatment



NEW



1 Disinfection Systems and Oxidation Systems

Technical Data

Capacity (as Cl ₂ equivalent)		Number of electrolysis cells	Product volume (NaOCl)		Salt consumption	
kg/h	kg/d		l/h	m ³ /d	kg/h	kg/d
5	14.4	1	625	15	16	384
7.5	180	1	935	22.5	24	576
10	240	2	1,250	30	32	768
15	360	2	1,875	45	48	1,152
20	480	4	2,500	60	64	1,536
22.5	540	3	2,810	67.5	72	1,728
30	720	4	3,750	90	96	2,304
45	1,080	6	5,625	135	144	3,456

All figures apply for 20 °C ambient temperature and 10-20 °C feed water. The performance of the system is affected by the temperature and quality of the water and salt.

System availability:	24 h/d
Salt usage:	3.2 kg/kg chlorine
Energy efficiency:	4.2 (DC) / 4.9 (AC) kWh/kg chlorine
Product concentration:	8 g/l (0.8 % ±0.05) chlorine
pH value of product (approx.):	9.5
Salt specifications:	CHLORINSITU® salt, salt tablets or salt with a grain size of ≥ 6 mm, min. 99.4 % NaCl, max. 0.05 % insoluble substances, max. 10 mg/kg iron, max. 10 mg/kg manganese, max. 100 mg/kg calcium + magnesium
Inlet water temperature:	10...20 °C (lower/higher temperatures require a heater/chiller)
Water supply (potable water quality):	2 bar < pressure < 5 bar and flow > 50 l/min; softened water, hardness < 0.05 °dH. A system separator or interim storage tank are needed for direct connection to the water supply (refer to local regulations)
Ambient conditions:	Non-condensing, non-corrosive and dust-free ambient air in the installation room
Salt dissolving tank:	customer-specific



1 Disinfection Systems and Oxidation Systems

1.4.6 Electrolysis System CHLORINSITU® III

Chlorine and sodium hydroxide made from common salt. Directly on site.

Output 100 – 10,000 g/h of chlorine



Ultra-pure or low-chloride and low-chlorate sodium-calcium hypochlorite requires specialist system technology. The electrolysis system CHLORINSITU® III is the solution. Can be used for potable water, waste water, process water, swimming pool water and in cooling towers.

Electrolysis systems of type CHLORINSITU® III generate sodium hypochlorite with a concentration of approximately 25 g/l with minimal entrainment of sodium chloride (85 % output) from the diaphragm cell into the finished product. A saturated solution of sodium chloride is produced in a salt-dissolving tank, included in the scope of delivery, and this solution is then electrolysed in a diaphragm cell. Sodium hydroxide solution and hydrogen are produced in the cathode chamber while ultra-pure active chlorine and a diluted residual brine are produced in the anode chamber, separated by the diaphragm from the cathode chamber. The resulting active chlorine is bound to the sodium hydroxide solution through an injector under constant vacuum and is collected as sodium hypochlorite in a product tank. The vacuum is kept constant by a frequency-controlled centrifugal pump. This creates less mechanical stress on the diaphragm in the electrolysis cell and in other parts of the system. The complete sodium hypochlorite solution can be metered, as required, by separate metering pumps. Due to its moderate pH value of 9.5 - 10, it affects the pH of the treated water significantly less than if conventional sodium-calcium hypochlorite with a pH of 12-13.5 were to be used. Much less acid is used to adjust the pH value, enabling savings of up to 70 %. The hydrogen always produced during electrolysis is diluted with fresh air by a fan and discharged safely. The salt-dissolving water comes from an integrated softener, preventing the formation of lime deposits and ensuring the long service life of the diaphragm cell. The efficiency of electrolysis is constantly monitored by various flow meters, with addition of water depending on the sodium hydroxide solution production and a dynamic level control in the product tank.

Your benefits

- Sodium hypochlorite solution low in chloride and chlorate with a high chlorine concentration (25 g/l free chlorine)
- Minimal acid consumption for pH correction, enabling savings of up to 70 %
- Safe system control with remote diagnosis by Remote Control Engineer
- Excellent service life of the diaphragm cells, thanks to a constant vacuum
- A frequency-controlled centrifugal pump maintains the vacuum constant in the enclosed anode area
- Excellent operating safety due to its design as a negative pressure system
- Dynamic level control in the product tank ensures optimised chlorine production
- Active process control of production by largely integrated measuring and control technology
- Cost-effective operation thanks to the use of sodium chloride as an inexpensive raw material and lower chemical consumption for pH value adjustment
- Lower chemical consumption
- Robust, simple technology
- Compact, space-saving design

Technical Details

- Modern PLC with large illuminated display
- Integrated Remote Control Engineer for remote diagnosis and troubleshooting
- Storage tank for multiple points of injection

Field of application

- Potable water
- Waste water
- Process water
- Swimming pool water
- Cooling tower

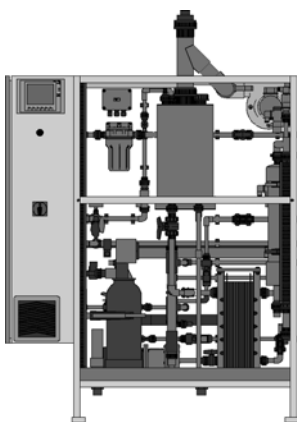

P_PMA_EL_0004_SW



1 Disinfection Systems and Oxidation Systems

Technical Data

Power supply 3 x 400 V (VAC/3P/N/PE/50 Hz)

Type/ output	Fuse	Power uptake	Max. salt consumption	Max. consumption of process water	Max. consumption of cooling water	Dimensions L x W x H (mm)	Brine tank	Recommend ed capacity storage tank
g/h	A	kW	kg/d	l/h	l/h		l	l
100	3 x 16	1.10	5	4	80	1,250 x 600 x 1,550	210	200
200	3 x 16	1.50	10	8	80	1,250 x 600 x 1,550	210	300
300	3 x 16	1.90	15	12	100	1,250 x 600 x 1,550	210	400
400	3 x 16	2.30	20	16	100	1,250 x 600 x 1,550	210	500
500	3 x 16	2.70	25	20	125	1,250 x 600 x 1,550	210	600
600	3 x 20	3.10	30	24	125	1,650 x 600 x 2,000	400	700
750	3 x 25	3.70	35	30	150	1,650 x 600 x 2,000	400	800
1,000	3 x 25	4.70	50	40	150	1,650 x 600 x 2,000	400	1,200
1,250	3 x 35	5.70	60	50	150	1,650 x 600 x 2,000	400	1,500
1,500	3 x 35	6.70	70	60	180	1,650 x 600 x 2,000	400	1,700
1,750	3 x 35	7.70	80	70	180	1,650 x 600 x 2,000	400	2,000
2,000	3 x 50	8.70	100	80	200	1,750 x 1,200 x 2,000	520	2,200
2,500	3 x 63	10.70	125	100	250	1,750 x 1,200 x 2,000	520	3,000
3,000	3 x 63	12.70	150	120	300	1,750 x 1,200 x 2,000	520	3,300
3,500	3 x 80	14.70	175	140	350	1,750 x 1,200 x 2,000	520	4,000
5,000	3 x 90	20.70	250	200	500	3,100 x 1,800 x 2,070	1,150	5,800
7,000	3 x 100	29.40	350	280	700	3,100 x 1,800 x 2,070	1,150	6,000
8,500	3 x 130	35.70	425	340	850	4,300 x 1,800 x 2,070	1,150	7,500
10,000	3 x 160	40.70	500	400	1,000	4,300 x 1,800 x 2,070	1,150	11,000

Scope of delivery:

Electrolysis systems of type CHLORINSITU® III are mounted ready-wired with a PLC Programmable Logic Controller on a powder-coated stainless steel frame in the control cabinet. They include a Remote Control Engineer for remote diagnosis and troubleshooting, integrated water softener system, membrane electrolysis cells, hydrogen bleed system and separate salt dissolving tanks with level monitoring unit. Dynamic level control to monitor the storage tank to be provided on site for sodium hypochlorite. A chlorine gas detector and automatic monitoring of water hardness downstream of the softening system come as standard with systems producing more than 600 g/h.

Note:

Electrolysis systems of type CHLORINSITU® II, III, V and V Plus are offered and planned to meet customer specifications. This is true both for the system documentation and the subsequent supply of spare parts and maintenance.



1 Disinfection Systems and Oxidation Systems

1.4.7 Electrolysis Systems CHLORINSITU® III Compact and IV Compact

Electrolysis System CHLORINSITU® III Compact

Chlorine produced from common salt. Directly on site.

Output 25 – 50 g/h of chlorine

Generation of sodium hypochlorite solution for smaller swimming pools and pools: Electrolysis system CHLORINSITU® III Compact.



Electrolysis systems of type CHLORINSITU® III Compact produce a disinfectant based on active chlorine. A saturated solution of sodium chloride is produced in a salt-dissolving tank, included in the scope of delivery, and this solution is then electrolysed in a diaphragm cell. Sodium hydroxide and hydrogen are produced in the cathode chamber while ultra-pure active chlorine and a diluted residual brine are produced in the anode chamber, separated by the diaphragm from the cathode chamber. The active chlorine produced forms sodium hypochlorite with a concentration of approx. 25 g/l in the reactor with the sodium hydroxide produced. The hydrogen generated is discharged to the fresh air through a bleed line. The salt-dissolving water comes from the integrated softener, preventing the formation of lime deposits and ensuring the long service life of the electrolysis cell. Electrolysis systems of type CHLORINSITU® III Compact are especially suitable for use with smaller swimming pools in residential properties and hotels (indoor pools with a total circulation capacity of up to 40 m³/hour, chlorinated in accordance with the DIN standard).

Your benefits

- Sodium hypochlorite solution low in chloride and chlorate with a high chlorine concentration (25 g/l free chlorine)
- Minimal acid consumption for pH correction, enabling savings of up to 70%
- Cost-effective operation, thanks to the use of sodium chloride as an inexpensive raw material and minimal chemical consumption for pH adjustment
- Robust, simple technology
- Compact space-saving design, ready-mounted on a wall panel

Technical Details

- The integrated microprocessor controller digitally indicates the current output and monitors all key functions.
- All operating and error messages are shown as plain text on the clear display.
- The output can be controlled manually, automatically (controller option) or externally.
- Optional integrated chlorine and pH control

Field of application

- Swimming pool
- Potable water
- Cooling tower

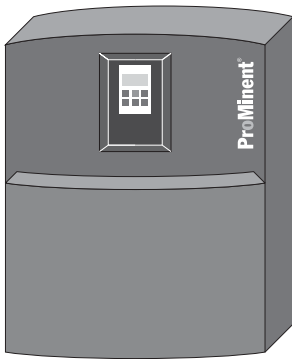

P_PMA_EL_0041_SW



1 Disinfection Systems and Oxidation Systems

Technical Data

Power supply 1 x 230 Volt (VAC/1P/N/PE/50 Hz)

Type/ output	Power uptake	Max. salt consumption	Max. consumption of process water	Dimensions L x W x H (mm)	Brine tank
g/h	kW	g/h	l/h		l
25	0.11	65	1.5	590 x 355 x 650	110
50	0.22	130	3	590 x 355 x 650	110

Scope of delivery:

Electrolysis systems of type CHLORINSITU® III Compact are ready mounted and wired for use on a wall panel. Chlorine electrolysis system with integrated microprocessor control and softener system. They include a diaphragm electrolysis cell, separate salt dissolving tank with level monitor and a level control for a storage tank (storage tank not included with the scope of delivery). A storage tank is also required as well as a metering pump for each point of injection (pump not included in the scope of delivery).

	Order no.
CHLORINSITU® III Compact 25	1041399
CHLORINSITU® III Compact 50	1041401

Spare parts and maintenance kits

	Type	Order no.
Annual maintenance set	CHLORINSITU® III Compact 25 + 50	1041407
3-yearly maintenance set	CHLORINSITU® III Compact 25	1041408
3-yearly maintenance set	CHLORINSITU® III Compact 50	1041410
Membrane cell	CHLORINSITU® III Compact 25	1041419
Membrane cell	CHLORINSITU® III Compact 50	1041420
Spare parts kit	CHLORINSITU® III Compact 25/50	1045233



1 Disinfection Systems and Oxidation Systems

Electrolysis System CHLORINSITU® IV Compact

Chlorine and sodium hydroxide made from common salt. Directly on site.

Output 25 – 50 g/h of chlorine

Generate ultra-pure chlorine gas using the vacuum method with electrolysis system CHLORINSITU® IV Compact. Cost-effective, robust and compact.

Electrolysis systems of type CHLORINSITU® IV Compact generate chlorine gas in a vacuum process. A saturated solution of sodium chloride is produced in a salt-dissolving tank, included in the scope of delivery, and this solution is then electrolysed in a diaphragm cell. Sodium hydroxide solution and hydrogen are produced in the cathode chamber while pure chlorine gas and dilute residual brine are produced in the anode chamber, separated by the diaphragm from the cathode chamber. The resulting chlorine gas is suctioned off through an injector integrated in the system and dissolved as hypochlorous acid in the water being treated. The hydrogen generated is discharged to the fresh air through a bleed line. The sodium hydroxide solution is disposed of or optionally used by a metering pump integrated in the system to correct the pH of the water being treated. The salt dissolving water comes from a softener integrated in the system, thereby preventing the formation of lime deposits and ensuring the long service life of the electrolytic cell. Electrolysis systems of type CHLORINSITU® IV Compact are especially suitable for use with smaller swimming pools in residential properties and hotels (indoor pools with a total circulation capacity of up to 25 m³/hour, chlorinated in accordance with the DIN standard).

Your benefits

- Chlorination and pH value adjustment in a single system
- Production and metering of high-purity hypochlorous acid
- Cost-effective operation thanks to the use of sodium chloride as an inexpensive raw material and no consumption of chemicals for pH adjustment
- Safe negative pressure system engineering
- Robust, simple technology
- Compact space-saving design, ready mounted on a wall panel

Technical Details

- The integrated microprocessor controller digitally indicates the current output and monitors all key functions.
- All operating and error messages are shown in plain text on the clear display.
- The output can be controlled manually, automatically or externally.

Field of application

- Swimming pool
- Potable water
- Cooling tower

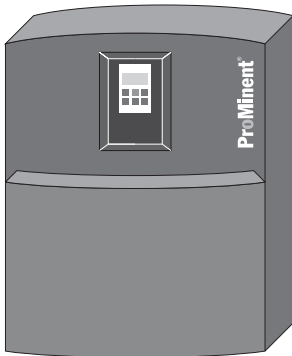

P_PMA_EL_0041_SW



1 Disinfection Systems and Oxidation Systems

Technical Data

Power supply 1 x 230 Volt (VAC/1P/N/PE/50 Hz)

Type/ output g/h	Power uptake kW	Max. salt consumption g/h	Max. consumption of process water l/h	Dimensions L x W x H (mm)	Brine tank l
25	0.11	65	1.5	590 x 355 x 650	110
50	0.22	130	3	590 x 355 x 650	110

Scope of delivery:

Electrolysis systems of type CHLORINSITU® IV Compact are ready mounted and wired for use on a wall panel. Chlorine electrolysis system with integrated microprocessor control and water softening system, diaphragm electrolysis cell with negative pressure monitoring, separate salt dissolving tanks with level control, integrated injector and integral feeder assembly for sodium hydroxide solution (optional). A booster pump is also needed (not included in the scope of delivery) for the single possible point of injection. Several pools cannot be fed from one Chlorinsitu® IV Compact system.

	Order no.
CHLORINSITU® IV Compact 25	1036461
CHLORINSITU® IV compact 25 with pH correction	1036462
CHLORINSITU® IV Compact 50	1036463
CHLORINSITU® IV Compact 50 with pH correction	1036464

Spare parts and maintenance kits

Note: Both the sensors and the metering pumps have to be maintained on systems with pH and/or chlorine control.

	Type	Order no.
Annual maintenance set	CHLORINSITU® IV Compact 25	1041415
3-yearly maintenance set	CHLORINSITU® IV Compact 25	1041416
Annual maintenance set	CHLORINSITU® IV Compact 25 with pH correction	1043267
3-yearly maintenance set	CHLORINSITU® IV Compact 25 with pH correction	1043268
Annual maintenance set	CHLORINSITU® IV Compact 50	1041417
3-yearly maintenance set	CHLORINSITU® IV Compact 50	1041418
Annual maintenance set	CHLORINSITU® IV Compact 50 with pH correction	1043269
3-yearly maintenance set	CHLORINSITU® IV Compact 50 with pH correction	1043270
Membrane cell	CHLORINSITU® IV Compact 25	1041419
Membrane cell	CHLORINSITU® IV Compact 50	1041420
Spare parts set	CHLORINSITU® IV Compact 25/50	1045232



1 Disinfection Systems and Oxidation Systems

1.4.8

Electrolysis System CHLORINSITU® V

Chlorine and sodium hydroxide made from common salt. Directly on site.

Output 100 – 3,500 g/h of chlorine

Ultra-pure active chlorine gas is generated in a vacuum process using the electrolysis system CHLORINSITU® V. Suited to applications for metering hypochlorous acid and simultaneously correcting the pH value.

Electrolysis systems of type CHLORINSITU® V generate ultra-pure chlorine gas in a vacuum process. A saturated solution of sodium chloride is produced in a salt-dissolving tank, included in the scope of delivery, and this solution is then electrolysed in a diaphragm cell. Chloride-free sodium hydroxide solution and hydrogen are produced in the cathode chamber, while ultra-pure chlorine gas and dilute residual brine are produced in the anode chamber, separated by the diaphragm from the cathode chamber. The chlorine gas produced is suctioned off through an injector (contained in the scope of delivery) and fully dissolved as hypochlorous acid in the water being treated (through a bypass). The chlorinated water is then distributed throughout the various pools via one or more proportionately controllable motor driven ball valves. The vacuum is kept stable by a single frequency-controlled booster pump. This permits significant savings in terms of energy. The chloride-free sodium hydroxide solution is stored temporarily and can be used for pH value correction. A standard diaphragm metering pump is first used to correct the base (pH 6.8 – 7) of the superchlorinated water. The fine correction of the pH value is provided via additional alkali metering pumps for each circuit or point of injection. The hydrogen produced is diluted with fresh air by a fan and discharged safely. The diluted residual brine is fully discarded. To achieve this, the diluted brine is strongly diluted with softened water, neutralised by the addition of sodium hydroxide solution and disposed of. All residual chloride and chlorate is thus disposed of and not mixed with the process water. Electrolysis systems of type CHLORINSITU® V can thus be compared with pure chlorine gas in terms of their oxidation strength and chloride / chlorate content in the process water. The salt-dissolving water comes from a softener integrated in the system, preventing the formation of lime deposits and ensuring the long service life of the diaphragm cell. The efficiency of electrolysis is constantly monitored by various flow meters, the addition of water depending on the sodium hydroxide solution production and the base pH correction.

Your benefits

- Chlorination and pH adjustment with a single system
- Exceedingly low chloride and chlorate content
- Production and metering of high-purity hypochlorous acid without temporary storage
- Safe system control with remote diagnosis by Remote Control Engineer
- Excellent service life of the diaphragm cells, thanks to a constant vacuum
- Excellent operating safety due to its design as a negative pressure system
- Active process control of production by largely integrated measuring and control technology
- Cost-effective operation thanks to the use of sodium chloride as an inexpensive raw material and no consumption of chemicals for pH adjustment
- Complete disposal of the diluted brine, nothing is fed back into the process water being treated
- Comparable with pure chlorine gas in terms of oxidation strength and chloride / chlorate content in the process water
- Robust technology
- Compact, space-saving design

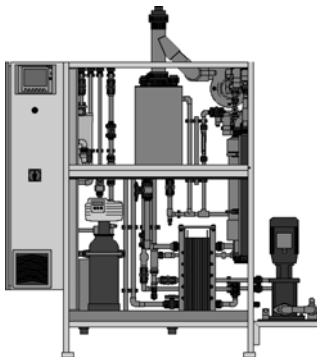

P_PMA_EL_0013_SW

Technical Details

- Modern PLC with large display
- Integrated Remote Control Engineer for remote diagnosis and troubleshooting
- Chlorine metering and pH value correction controlled via contact inputs
- Analogue input (optional)
- Modbus or PROFIBUS® (optional)
- Several points of injection (optional)
- Multiple booster pumps (optional) can be used for different water qualities (e.g. brine and freshwater pools)

Field of application

- Potable water
- Process water
- Swimming pool water
- Cooling tower

1 Disinfection Systems and Oxidation Systems

Technical Data

Power supply 3 x 400 V (VAC/3P/N/PE/50 Hz)

Type/ output g/h	Fuse A	Power uptake kW	Max. salt consumption kg/d	Max. consumption of process water l/h	Consumption of cooling water (external) l/h	Dimensions L x W x H (mm)	Brine tank l
100	3 x 16	1.10	5	60	–	1,655 x 600 x 1,550	210
200	3 x 16	1.50	10	60	–	1,655 x 600 x 1,550	210
300	3 x 16	1.90	15	60	–	1,655 x 600 x 1,550	210
400	3 x 16	2.30	20	60	–	1,655 x 600 x 1,550	210
500	3 x 16	2.70	25	60	–	1,655 x 600 x 1,550	210
600	3 x 20	3.10	30	90	–	1,950 x 600 x 2,000	400
750	3 x 25	3.70	35	90	–	1,950 x 600 x 2,000	400
1,000	3 x 25	4.70	50	90	–	1,950 x 600 x 2,000	400
1,250	3 x 35	5.70	60	90	–	1,950 x 600 x 2,000	400
1,500	3 x 35	6.70	70	90	–	1,950 x 600 x 2,000	400
1,750	3 x 35	7.70	80	90	–	1,950 x 600 x 2,000	400
2,000	3 x 50	8.70	100	175	200	1,750 x 1,200 x 2,000	520
2,500	3 x 63	10.70	150	175	250	1,750 x 1,200 x 2,000	520
3,000	3 x 63	12.70	175	175	300	1,750 x 1,200 x 2,000	520
3,500	3 x 80	14.70	175	175	350	1,750 x 1,200 x 2,000	520

Capacities > 3,500 g/h upon request

Scope of delivery:

Electrolysis systems of type CHLORINSITU® V are ready mounted, wired for use, on a powder coated stainless steel frame with a Programmable Logic Controller (PLC) in the control cabinet, Remote Control Engineer for remote diagnosis and troubleshooting, integral water softening unit, diaphragm electrolysis cells, hydrogen bleed system and separate salt dissolving tank with level monitoring. The scope of delivery also includes a frequency-controlled central injector system matched to the system to meter active chlorine and sodium hydroxide solution for pH correction and a single booster pump. A chlorine gas detector and automatic monitoring of water hardness downstream of the softening system come as standard with systems producing more than 600 g/h.

Note:

Electrolysis systems of type CHLORINSITU® II, III, V and V Plus are offered and planned to meet customer specifications. This is true both for the system documentation and the subsequent supply of spare parts and maintenance.



1 Disinfection Systems and Oxidation Systems

1.4.9

Electrolysis System CHLORINSITU® V Plus

Chlorine and sodium hydroxide made from common salt. Directly on site.

Output 100 – 3,500 g/h of chlorine

Chlorine gas in the vacuum process PLUS production of sodium hypochlorite solution with the electrolysis system CHLORINSITU® V Plus. Chlorination and pH value adjustment from a single system.

Electrolysis systems of type CHLORINSITU® V Plus generate ultra-pure chlorine gas combined with a sodium hypochlorite solution in a vacuum process. A saturated solution of sodium chloride is produced in a salt-dissolving tank, included in the scope of delivery, and this solution is then electrolysed in a diaphragm cell. Chloride-free sodium hydroxide solution and hydrogen are produced in the cathode chamber, while ultra-pure chlorine gas and residual brine are produced in the anode chamber, separated by a diaphragm from the cathode chamber. The resulting ultra-pure chlorine gas is further processed in two ways. Firstly, it is suctioned off through an injector (included in the scope of delivery) and fully dissolved as hypochlorous acid in the water being treated (through a bypass). The superchlorinated water is then distributed throughout the various pools via one or more proportionately controllable motor driven ball valves. The vacuum is kept stable by a single frequency-controlled booster pump. This permits significant savings in terms of energy. If the complete production output is not needed, excess chlorine gas can be combined with the sodium hydroxide solution produced and then temporarily stored as sodium hypochlorite (PLUS system). The system thus does not have to be sized based on the maximum chlorine gas demand rather on the average daily demand. Peaks in demand are met by the additional metering of sodium hypochlorite from the temporary reservoir, which, as with hypochlorous acid, is fed through a central injector system.

The chloride-free sodium hydroxide solution is stored temporarily and can be used for pH value correction. First the base pH (pH 6.8 – 7) of the superchlorinated water is corrected by a standard diaphragm metering pump or through the addition of sodium hypochlorite. The fine correction of the pH value is provided via additional alkali metering pumps for each circuit or point of injection. They are connected directly to the system's control through an external pH value controller. The hydrogen produced is seriously diluted with fresh air by a fan and discharged safely. The residual brine is fully discarded. To achieve this, the residual brine is strongly diluted with softened water, neutralised by the addition of sodium hydroxide solution and disposed of in the sewer. Any residual chloride and chlorate is thereby disposed of and not mixed with the process water. Electrolysis systems of type CHLORINSITU® V Plus can therefore be compared with pure chlorine gas in terms of their oxidation strength and chloride / chlorate content in the process water. The salt-dissolving water comes from a softener integrated in the system, preventing the formation of lime deposits and ensuring the long service life of the diaphragm cell. The efficiency of the electrolysis is constantly monitored by various flow meters, the addition of water depending on the sodium hydroxide solution production and the base pH correction.

Your benefits

- Chlorination and pH adjustment with a single system
- Exceedingly low chloride and chlorate content
- Reservoir of sodium hypochlorite solution to cover peak demand
- Production and metering of high-purity hypochlorous acid combined with sodium hypochlorite production
- Excellent service life of the membrane cells, thanks to a constant vacuum
- Maximum operating safety due to their design as negative pressure systems
- Active process control of production by largely internal measuring and control technology
- Cost-effective operation thanks to the use of sodium chloride as an inexpensive raw material and low consumption of chemicals for pH correction
- Robust technology
- Compact, space-saving design

Technical Details

- Modern PLC with large display
- Integrated Remote Control Engineer for remote diagnosis and troubleshooting
- Chlorine metering and pH value correction controlled via contact inputs
- Simultaneous production and metering of ultra-pure hypochlorous acid and sodium hypochlorite solution (optional)
- Analogue input (optional)
- Modbus or PROFIBUS® (optional)
- Several points of injection (optional)
- Multiple booster pumps (optional) can be used for different water qualities (e.g. brine and freshwater pools)

Field of application

- Potable water
- Process water
- Swimming pool water
- Cooling tower

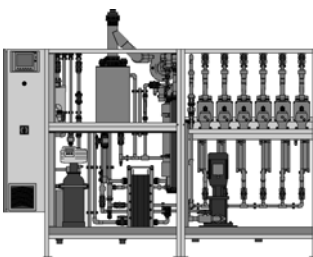

P_PMA_EL_0012_SW

1 Disinfection Systems and Oxidation Systems

Technical Data

Power supply 3 x 400 V (VAC/3P/N/PE/50 Hz)

Type/ output	Fuse	Power uptake	Max. salt consumption	Max. consumption of process water*	(External) consumption of cooling water	Dimensions L x W x H (mm)	Brine tank	Recommen- ed capacity storage tank
g/h	A	kW	kg/d	l/h	l/h		l	l
100	3 x 16	1.10	5	60	–	1,655 x 600 x 1,550	210	50
200	3 x 16	1.50	10	60	–	1,655 x 600 x 1,550	210	100
300	3 x 16	1.90	15	60	–	1,655 x 600 x 1,550	210	150
400	3 x 16	2.30	20	60	–	1,655 x 600 x 1,550	210	200
500	3 x 16	2.70	25	60	–	1,655 x 600 x 2,000	210	250
600	3 x 20	3.10	30	90	–	1,950 x 600 x 2,000	400	300
750	3 x 25	3.70	40	90	–	1,950 x 600 x 2,000	400	400
1,000	3 x 25	4.70	55	90	–	1,950 x 600 x 2,000	400	500
1,250	3 x 35	5.70	60	90	–	1,950 x 600 x 2,000	400	600
1,500	3 x 35	6.70	75	90	–	1,950 x 600 x 2,000	400	750
1,750	3 x 35	7.70	85	90	–	1,950 x 600 x 2,000	400	850
2,000	3 x 50	8.70	100	175	200	1,750 x 1,200 x 2,000	520	1,000
2,500	3 x 63	10.70	125	175	250	1,750 x 1,200 x 2,000	520	1,250
3,000	3 x 63	12.70	150	175	300	1,750 x 1,200 x 2,000	520	1,500
3,500	3 x 80	14.70	175	175	350	1,750 x 1,200 x 2,000	520	1,750

* The consumption of process water depends on the ratio of chlorine gas to stock production. The value is given here for a ratio of 70% : 30 %.

Capacities > 3,500 g/h upon request

Scope of delivery:

Electrolysis systems of type CHLORINSITU® V Plus are ready mounted, wired for use, on a powder-coated stainless steel frame with a Programmable Logic Controller (PLC) in the control cabinet, Remote Control Engineer for remote diagnosis and troubleshooting, integral water softening unit, diaphragm electrolysis cells, hydrogen bleed system and separate salt dissolving tank with level monitoring. The scope of delivery also includes a frequency-controlled central injector system matched to the system to meter active chlorine and sodium hydroxide solution for pH correction and a single booster pump. A level control to monitor the storage tank to be provided on site for sodium hypochlorite. A chlorine gas detector and automatic monitoring of water hardness downstream of the softening system come as standard with systems producing more than 600 g/h.

Note:

Electrolysis systems of type CHLORINSITU® II, III, V and V Plus are offered and planned to meet customer specifications. This is true both for the system documentation and the subsequent supply of spare parts and maintenance.



1 Disinfection Systems and Oxidation Systems

1.4.10 Questionnaire on the Design of a DULCO®Lyse Electrolysis System

Application

- Bottler flushing
- CIP
- Other _____

Applicational details

Number of bottlers: _____

Flushing duration: _____

Required volume to be added to bottler: _____ Recommendation with material SS 316 L 2-4 ppm

Number of CIP points of injection: _____

Duration of CIP: _____

Required volume to be added for CIP: _____ Recommendation 10-15 ppm

Water data:

Max. volume of water to be treated _____ m³/h maximum water pressure _____ bar

Water flow constant fluctuating from _____ m³/h to _____ m³/h

pH value _____ (iron (Fe²⁺) _____ mg/l)

Temperature _____ °C (manganese (Mn²⁺) _____ mg/l)

Proportion of solids _____ mg/l (nitrite (NO₂⁻) _____ mg/l)

Acid capacity K_{s4,3} _____ mmol/l (sulphide (S²⁻) _____ mg/l)

Total hardness _____ mmol/l (TOC (total organic carbon) _____ mg/l)

Total hardness _____ °dH (ammonium _____ mg/l)

Reaction time to application:

_____ m³ volume of reaction tank or _____ minutes dwell time in the total system.

Disinfection method used to date:

Disinfectant consumed to date: _____ kg/week

Other requirements:



1 Disinfection Systems and Oxidation Systems

1.4.11 Electrolysis System DULCO®Lyse

Innovative disinfection. The benefits for you: Minimum chlorate and chloride content.

Output: Up to 300 m³/h of water disinfection with the lowest concentration of by-products

Efficient production of DULCO®Lyt 400 with an exceptionally low chloride and chlorate content. Maximum protection against corrosion and very good cost efficiency because of low chloride.



Electrolysis systems of the type DULCO®Lyse generate ultra-pure hypochlorous acid in a vacuum process. A saturated solution of sodium chloride is produced in a salt-dissolving tank, included in the scope of delivery, and this solution is then electrolysed in a diaphragm cell. Chloride-free sodium hydroxide solution and hydrogen are produced in the cathode chamber, while ultra-pure chlorine gas and dilute residual brine are produced in the anode chamber, separated by the diaphragm from the cathode chamber. The chlorine gas produced is immediately separated from the residual brine and dissolved as hypochlorous acid. The sodium hydroxide solution is temporarily stored and added to hypochlorous acid through a metering pump. The result is a neutral, highly effective and extremely low-chloride and low-chlorate disinfection solution, temporarily stored in the product tank until metered through separate metering stations. The hydrogen produced is diluted with fresh air by a fan and discharged safely. The diluted residual brine is fully discarded. To this end, the diluted brine is heavily diluted with softened water, neutralised by the addition of sodium hydroxide solution and disposed of in the sewer. Any residual chloride and chlorate is thereby disposed of and not mixed with the process water. DULCO®Lyse systems can thus be compared with pure chlorine gas in terms of their oxidation strength and chloride and chlorate content in the process water. The salt dissolving water comes from a softening system integrated in the DULCO®Lyse system, thereby preventing the formation of lime deposits and ensuring the long service life of the electrolytic cell.

Your benefits

- Ultra-low chlorate content for disinfection with minimal by-products
- Extremely low chloride content for maximum protection and freedom from corrosion within the plant
- Environmentally-friendly, highly effective disinfection
- Long-term freedom from germs, without any transport, storage or handling of concentrated chemicals
- Handling of chemicals is reduced (only sodium chloride is required)
- Compact, space-saving design
- Cost-effective operation, thanks to use of inexpensive sodium chloride as a raw material

Technical Details

- Modern PLC with large display
- Integrated Remote Control Engineer for remote diagnosis and troubleshooting
- Supplied ready for connection in stainless steel housing
- Duplex softening system
- Salt-dissolving tank with level monitoring

Field of application

- Food industry
- Beverage industry

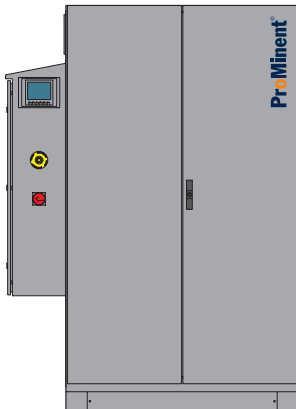

P_PMA_EL_0042_SW



1 Disinfection Systems and Oxidation Systems

Technical Data

Power supply: 1 x 230 Volt (V AC/1P/N/PE/50 Hz)

Dimensions (H x W x D): 2,100 x 1,250 x 610 mm

	Type/ output g/h	DULCO®Lyt production at 400 ppm l/h	Power uptake kW	Salt solution tank volume l	Cabinet	Order no.
DULCO®Lyse 100	100	250	1.10	210	stainless steel cabinet	1041424
DULCO®Lyse 100	100	250	1.10	210	open cabinet	1062093
DULCO®Lyse 200	200	500	1.50	210	stainless steel cabinet	1043987
DULCO®Lyse 200	200	500	1.50	210	open cabinet	1062104
DULCO®Lyse 300	300	750	1.90	210	stainless steel cabinet	1043988
DULCO®Lyse 300	300	750	1.90	210	open cabinet	1062135

Scope of delivery:

DULCO®Lyse electrolysis systems are assembled ready-wired in a sealed stainless steel or open cabinet

- PLC (Programmable Logic Controller) in the attached control cabinet
- Duplex water softening system
- Salt-dissolving tank with level monitoring
- Ultrasound level probe for the DULCO®Lyt product tank
- Piping between the salt-dissolving storage tank and DULCO®Lyse system
- Hardness control measuring device
- pH4 + pH7 buffer solution
- 25 kg salt for commissioning

Not included in the scope of delivery:

- DULCO®Lyt product tank
- DULCO®Lyt metering station

Spare parts and maintenance kits

	Type	Order no.
Annual maintenance kit	DULCO®Lyse 100 – 300	1041427
3-yearly maintenance kit	DULCO®Lyse 100 – 300	1041430
Spare parts kit up to manufacturing year 2015	DULCO®Lyse 100 – 300	1044366
Spare parts kit from manufacturing year 2015 onwards	DULCO®Lyse 100 – 300	1079469

1 Disinfection Systems and Oxidation Systems

1.4.12 Accessories

Water hardness measuring kit

For manual determination of the overall hardness

	Order no.
Water hardness measuring kit for overall hardness	505505

Metering systems for connection to DULCO®Lyse

Metering systems for connection to electrolysis systems DULCO®Lyse including 500 l product tank and solenoid-driven metering pump delta®. Maximum metering of Cl₂: 0.5 ppm.

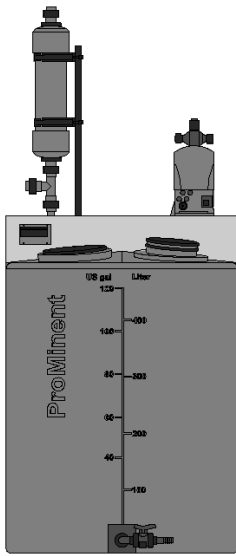

P_PMA_EL_0039

Water flow	Identity code for delta®	Pump capacity at max. back pressure	Feed rate at max. pressure	Order no.
m ³ /h		bar	l/h	
5 – 40	DLTA0450PVT2000UK1030DE0	4.0	50	1076955
5 – 60	DLTA0280PVT2000UK1030DE0	2.0	80	1077098

DULCO®Lyse product tanks for connection to the metering system DULCODOS® DSKa

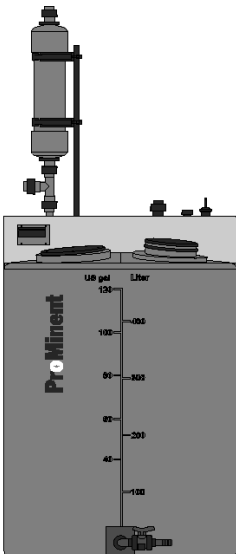

P_PMA_EL_0048

Contents	Order no.
l	
500	1076956
1000	1076957



1 Disinfection Systems and Oxidation Systems

1

DULCO®Lyse new electrolysis cells

	Capacity g/h	Order no.
Membrane cell	100	1041433
HMC 10-2	200	1074133
HMC 10-3	300	1074134

Metering systems DULCODOS® DSKa for connection to DULCO®Lyse product tanks

Metering system DULCODOS® DSKa for connection to DULCO®Lyse product tank, for motor-driven metering pump Sigma, electrically and mechanically ready mounted on a PP frame. Scope of delivery:

- Diaphragm damper
- Back pressure valve
- Relief valve including manometer
- Flushing connector for suction and discharge side
- Repair switch
- Select the metering pump separately, see Metering pumps table

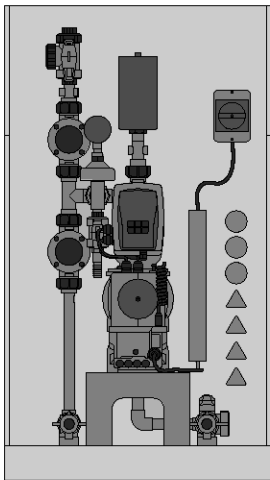

P_PMA_EL_0038

	Feed rate max. l/h	Order no.
Metering system for Sigma/ 1 (control type)	53/101/117	1083511
Metering system for Sigma/ 2 (control type)	150/271/353	1077030
Metering system for Sigma/ 3 (control type)	500/670	1077109
Metering system for Sigma/ 3 (control type)	670 – 1040	1083512

Recommended metering pumps for metering systems DULCODOS® DSKa:

Pump type	Identity code
Sigma/ 2 (control type)	S2CBH 07220 PVTS 010 U 1110S0 EN
Sigma/ 2 (control type)	S2CBH 04350 PVTS 010 U 1110S0 EN
Sigma/ 3 (control type)	S3CBH 070580 PVTS 110 U 1110S0 EN

Accessories for metering systems DULCODOS® DSKa

	Order no.
Spray guard hood for DULCODOS® DSKa	1042751
Spray guard hood for DULCODOS® DSKa for PP bracket without terminal box	1040456

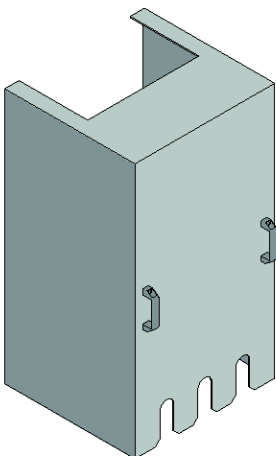

P_DST_0007



1 Disinfection Systems and Oxidation Systems

1.5 Chlorine Gas Metering Systems DULCO®Vaq

1.5.1 General Information on Chlorine Gas Metering Systems

Chlorine gas metering systems are used in water treatment for disinfection and oxidation. They prevent and/or reduce the growth of micro-organisms.

The safety of users is the priority. This is essentially guaranteed by vacuum operation directly from the chlorine gas tank and downstream of the evaporator. This ensures that the escape of chlorine gas can be prevented even in the event of a ruptured pipe.

All the components are perfectly coordinated to each other and ensure seamless operation. With higher demand, several storage tanks can be combined using manifolds. Uninterrupted chlorine gas supply can be ensured by the use of an automatic vacuum switch.

Chlorine gas stands out on account of its high bacteria destruction speed coupled with low operating costs. Due to the high level of reactivity, sensible handling and compliance with common safety regulations (e.g. DIN 19606, BGV D5 / DGUV-V 50, BGR/GUV-R 108 and other regional regulations) is imperative.

No by-products are metered by the use of pure chlorine gas and thus the water quality is maintained. Furthermore, chlorine gas can be stored as required without forming decomposition products.

Chlorine is a pungent smelling yellow/green gas in its normal state. The density is $\sim 3.2 \text{ kg/m}^3$, thus chlorine gas is heavier than air. Chlorine is supplied in liquid form and changes to its gaseous state during extraction caused by reduced pressure. The vacuum generated by an injector draws the chlorine gas by suction to the point of injection. The chlorine gas is dissolved in water and produces hypochlorous acid responsible for disinfection.

Make sure that only a technical expert carries out commissioning, maintenance and repair. Compliance with national and regional regulations is mandatory.

Chlorine Gas Metering Systems DULCO®Vaq

In the metering system DULCO®Vaq, chlorine gas is safely handled under a vacuum. The negative pressure generated in the injector opens the vacuum dosing regulator fitted on the chlorine gas tank and the chlorine gas enters the water to be treated. Adjustment valves control the metering volume and flow meters precisely indicate the chlorine gas flow. A large number of individual configurations is provided for by the use of additional components, such as motorised control valves, injectors or vacuum switch-overs.

ProMinent DULCO®Vaq components are used for large-scale chlorine gas systems for applications in industry and the treatment of large volumes of water. Additional components, such as evaporators, pressure reducing valves, pressure switch-overs, metering systems and corresponding room equipment.

ProMinent experts consider the latest safety requirements when designing systems for specific projects.

Perfect safety for operators and users with ProMinent chlorine gas metering systems DULCO®Vaq.



1 Disinfection Systems and Oxidation Systems

1.5.2 Performance Overview of Chlorine Gas Metering Systems DULCO®Vaq

The components of the DULCO®Vaq series are sub-divided into small and medium chlorine gas systems, as well as large systems, the suitability of which is outlined below:

Applications	12 – 15,000 g/h	20 – 200 kg/h
Potable water	x	x
Swimming pool water	x	x
Waste water	x	x
Cooling water	x	x

Instructions on the planning and design of a chlorine gas metering system

- 1 Chlorine gas cylinder
- 2 Vacuum metering controller
- 3 Vacuum switch-over
- 4 Vacuum safety valve
- 5 Active carbon filter
- 6 Gas warning sensor
- 7 Heating
- 8 Sprinkler system
- 9 Flashing light and horn
- 10 Automatic chlorine gas metering system
- 11 DULCOMARIN®
- 12 Gas detector
- 13 Process water set
- 14 Injector
- 15 Booster pump
- 16 Injection point

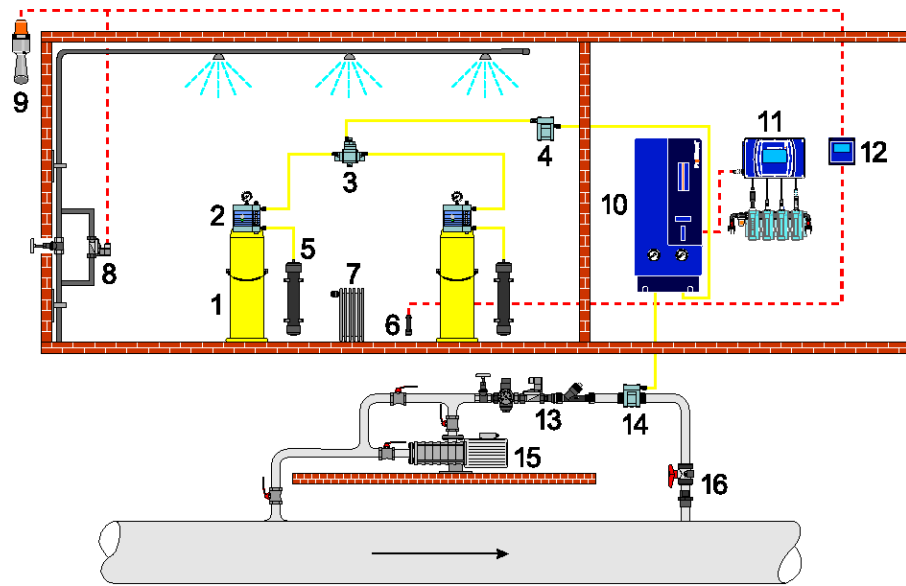

P_DV_0023

The following details are required for the design of a chlorine gas system:

- Purpose of use
- Maximum water flow of the water to be treated
- Maximum back pressure at the feed point

Individual plans for large systems and for specific applications on request.

1 Disinfection Systems and Oxidation Systems

1.5.3 Questionnaire on the Design of a Chlorine Gas Metering System

Use of the chlorine gas system:

For the disinfection of

- Potable water
- Swimming pool water
- Waste water
- Cooling water
- _____

Water values:

Max. water flow

_____ m³/h

Water flow

- constant
- fluctuating from _____ m³/h to _____ m³/h

Back pressure in the main line

_____ bar

pH value

Temperature

_____ °C

Solids proportion

_____ mg/l

Acid capacity K_{S4,3}

_____ mmol/l

Distance from the vacuum controller to the injector

_____ m

Type of metering:

- manual
- automatic
- flow-proportional
- measured value-dependent
- both

Required feed volume:

_____ mg/l

Required concentration after chlorine gas metering:

_____ mg/l

Design of the system:

Number of points of injection

Vacuum controller duty / standby

yes / no

Chlorine gas unit duty / standby

yes / no

Chlorine gas cylinders or drums

_____ cylinder(s) _____ kg
 _____ drum(s) _____ kg

Booster pump fitted

yes / no

Other requirements:



1 Disinfection Systems and Oxidation Systems

1.5.4 Vacuum controller for chlorine gas DULCO®Vaq

Chlorine gas metering – safe, robust and reliable

Capacity: up to 200 kg/h

The vacuum controller DULCO®Vaq CGVa meters chlorine gas cost-effectively and efficiently. Maximum possible operating safety and reliability is ensured by the use of high-quality materials, such as tantalum and silver.

Chlorine gas is reliably handled under vacuum with the vacuum controller DULCO®Vaq. The negative pressure generated in the injector opens the inlet valve in the vacuum controller and chlorine gas flows into the controller. There the chlorine gas is transferred into the vacuum directly downstream of the inlet valve and drawn in a controlled manner into the water to be treated. The optional control valve enables the volume of chlorine gas to be adjusted directly at the vacuum controller. The additional equipment includes a flow indicator to display the chlorine gas mass flow and a storage tank empty signal. We offer accessories, such as adjustment valves, injectors, manometers or electrical status signals, to meet individual requirements. This ensures precise configuration and correct metering.

Your benefits

- Maximum safety thanks to the full vacuum system
- Operating safety and reliability by the use of high-quality materials, like tantalum and silver
- Coordinated components and accessories
- Integrated safety bleeding

Technical Details

- Sturdy ABS housing
- All critical chlorine-wetted parts are made of high-grade materials, such as PTFE, tantalum and silver
- Flow indicator for display of the chlorine gas mass flow and an optical storage tank empty signal
- 5 different connector dimensions for the chlorine gas tank
- Manometer with limit contact to monitor the chlorine gas pressure in the storage tank (optional)
- Potential-free contact (not self-resetting) to signal the empty state of the chlorine gas storage tank (optional)
- Residual pressure safety mechanism (optional)
- Standard chlorine gas filter (optional from 20 kg/h)
- Adjustment valve with V-nozzle for control of the gas volume
- from 20 kg/h including liquid trap and heating

Field of application

- Potable water
- Swimming pool water
- Waste water
- Cooling water

Dimensional drawing (output 12 – 4,000 g/h)

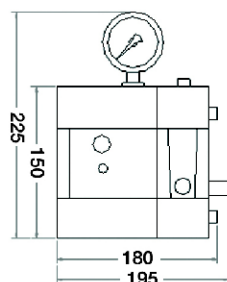

P_DV_0010_SW

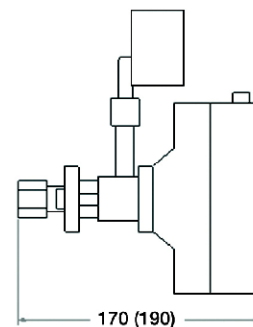

P_DV_0011_SW

P_DV_0025_SW

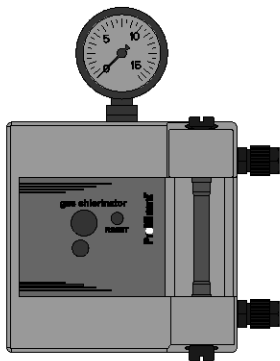

1 Disinfection Systems and Oxidation Systems

Dimensional drawing (output 10 – 15 kg/h)

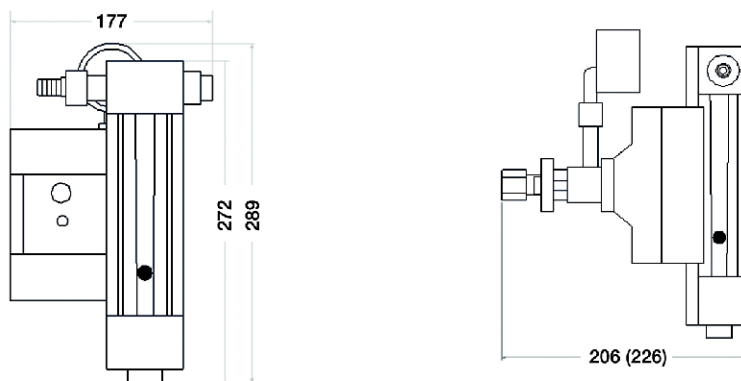

P_DV_0008_SW

P_DV_0009_SW

Requirement of vacuum line for chlorine gas

max. gas flow	Length of vacuum line					
	15 m	30 m	60 m	100 m	200 m	300 m
1,000 g/h	d8/d10	d8/d10	d8/d10	d8/d10	d8/d10	d8/d10
2,000 g/h	d8/d10	d8/d10	d8/d10	d8/d16	d8/d16	d20
4,000 g/h	d8/d10	d8/d10	d8/d16	d20	d20	d25
10 kg/h	d12/d16	d20	d25	d25	d32	d32
15 kg/h	d12/d16	d20	d25	d32	d40	d40
20 kg/h	d20	d25	d32	d40	d50	d50
40 kg/h	d25	d32	d40	d50	d50	d50
60 kg/h	d50	d50	d50	d50		
80 kg/h	d50	d50	d50	d50		
120 kg/h	d50	d50	d50	d50		
160 kg/h	d50	d50				
200 kg/h	d50	d50				

Technical Data

Type	Capacity kg/h	Connector on the vacuum side	Discharge side connector (standard)	Weight kg
CGVa012g	0.012	d8/d10	1"	3.1
CGVa025g	0.025	d8/d10	1"	3.1
CGVa100g	0.1	d8/d10	1"	3.1
CGVa200g	0.2	d8/d10	1"	3.1
CGVa500g	0.5	d8/d10	1"	3.1
CGVa001k	1	d8/d10	1"	3.1
CGVa002k	2	d8/d10	1"	3.1
CGVa004k	4	d8/d10*	1"	3.1
CGVa010k	10	d12/d16	1"	3.9
CGVa015k	15	d12/d16	1"	3.9
CGVa020k	20	d20 - 3/4"	G3/4"	19.0
CGVa040k	40	d25 - 1"	G3/4"	19.0
CGVa060k	60	d50 - 2"	G3/4"	19.0
CGVa080k	80	d50 - 2"	G3/4"	19.0
CGVa120k	120	d50 - 2"	D3/4"	19.0
CGVa160k	160	d50 - 2"	G1"	19.0
CGVa200k	200	d50 - 2"	G1"	19.0

* from 30 m pipe length: d12/d16

Precision: 4% of the flow



1 Disinfection Systems and Oxidation Systems

Identity code ordering system for vacuum controller DULCO®Vaq

CGVa	Type	Capacity
		kg/h
	CGVa012g	0.012
	CGVa025g	0.025
	CGVa100g	0.1
	CGVa200g	0.2
	CGVa500g	0.5
	CGVa001k	1
	CGVa002k	2
	CGVa004k	4
	CGVa010k	10
	CGVa015k	15
	CGVa020k	20
	CGVa040k	40
	CGVa060k	60
	CGVa080k	80
	CGVa120k	120
	CGVa160k	160
	CGVa200k	200
	Design	
	P	ProMinent
	M	modified
	Flow meter with adjustment valve	
	0	none
	1	with flow meter without adjustment valve (≤ 15 kg/h)
	2	with flow meter with adjustment valve (≤ 15 kg/h)
	Manometer	
	0	none
	1	with
	2	with manometer with limit contact
	Empty signal contact	
	0	none
	1	with (≤ 15 kg/h)
	Residual pressure pressur lock	
	0	none
	1	with (≤ 15 kg/h) (not available with yoke connector)
	Connector	
	0	Standard (1")
	1	1.030" CGA (≤ 15 kg/h)
	2	5/8" BSP (≤ 15 kg/h)
	3	M 27x1.5 (≤ 15 kg/h)
	4	yoke (≤ 15 kg/h)
	5	3/4" (≤ 15 kg/h)
	Operating instructions	
	DE	German
	EN	English
	FR	French
	ES	Spanish

Vacuum controller accessories

Flow limiter 900 g/h

For limiting the throughput of a vacuum controller to 900 g/h for instance with continuously extraction from multiple cylinders. Designed as a PVDF fitting, screwed into the output of the vacuum controller.

	Order no.
Flow limiter 900 g/h	1082816



1 Disinfection Systems and Oxidation Systems

1.5.5

Motor-Driven Control Valve for Chlorine Gas DULCO®Vaq

Chlorine gas metering, precisely regulated

Capacity: 12 g/h to 15 kg/h



The motorised control valve for chlorine gas DULCO®Vaq type PM 3531 ensures precise electronically controlled metering of the chlorine gas flow. The linear control characteristic is guaranteed by an externally controlled step motor.

The DULCO®Vaq motorised control valve is fitted in the vacuum system between the vacuum controller and injector. The chlorine gas flow is therefore automatically adjusted. A step motor thus controls the ultra-precise V-nozzle, which results in a linear control characteristic. Control is either provided by manual adjustment on the keyboard of the device, via external signals, such as 0/4-20 mA, 0/2-10 V or Modbus. Opening and operating statuses are signalled externally by analogue and digital outputs and by coloured LEDs on the device. In the event of power failure, the valve closes automatically, although mechanical manual operation is possible.

Your benefits

- Linear control action for precise metering
- Multiple control and signalling functions
- Automatic and manual operation
- Calibratable
- Automatic safety shut-off
- Easy control e.g. using DULCOMARIN® or DACb controller

Technical Details

- External control via 0/4-20 mA, 0/2-10 V or Modbus
- Manual operating mode, which can be adjusted by the keyboard on the device
- Mechanically adjustable emergency mode
- Control via V-nozzle with $\pm 5\%$ control precision
- 5-point calibration
- Manometer for vacuum display
- 4-20 mA output
- Fault indicating output (potential-free contact)
- LED display of the opening status
- Power supply 24 V DC
- Protection class IP 65
- Weight: 2.9 kg
- Dimensions: 320 x 120 x 160 mm

Field of application

- Potable water
- Swimming pool water
- Waste water
- Cooling water

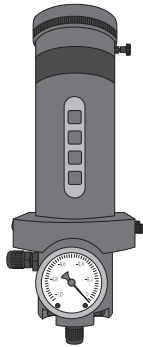

P_DV_0012_SW



1 Disinfection Systems and Oxidation Systems

Technical Data

with vacuum meter

Capacity kg/h	Connector	Order no.
0.012	d8/d10	1077197
0.025	d8/d10	1077198
0.1	d8/d10	1077199
0.2	d8/d10	1077200
0.5	d8/d10	1077201
1	d8/d10	1077202
2	d8/d10	1077203
4	d8/d10	1077204
10	d12/d16	1077205
15	d12/d16	1077207

without vacuum meter

Capacity kg/h	Connector	Order no.
0.012	d8/d10	1078422
0.25	d8/d10	1078425
0.1	d8/d10	1077723
0.2	d8/d10	1077764
0.5	d8/d10	1078426
1	d8/d10	1078427
2	d8/d10	1078428
4	d8/d10	1078429
10	d12/d16	1078430
15	d12/d16	1078432

Note: A flow meter needs to be fitted to read off the exact flow and calibrate the motorised control valve. Not included in the scope of delivery.

1 Disinfection Systems and Oxidation Systems

1.5.6 Manual Chlorine Gas Metering Unit DULCO®Vaq PM3720 C

Panel-mounted chlorine gas metering system for wall mounting. For precise gas metering with manual adjustment via the control valve.

Includes:

- Long-scale gas flow meter with manual adjustment valve; adjustment range 1:20
- Differential pressure controller in accordance with DIN 19606
- Vacuum manometer
- Vacuum non-return valve

Technical Data

Dimensions (HxWxD): 500 x 400 x 120 mm

with vacuum meter

Type	Capacity kg/h	Order no.
PM3720C/3UDP	0.1	1092925
PM3720C/4UDP	0.2	1092926
PM3720C/5UDP	0.5	1092927
PM3720C/6UDP	1	1092928
PM3720C/7UDP	2	1092929
PM3720C/8UDP	4	1092930
PM3720C/9UDP	10	1092931
PM3720C/15UDP	15	1092932



1 Disinfection Systems and Oxidation Systems

1.5.7

Automatic Chlorine Gas Metering System DULCO®Vaq

Maximum safety and precision in chlorine gas metering.

Capacity: 12 g/h - 15 kg/h

The chlorine gas metering system DULCO®Vaq type PM 3610 C for automatically controlled metering of chlorine gas. Its simple operation offers safety and precision in accordance with the current state of technology and in line with DIN standards.

The automatic chlorine gas metering system DULCO®Vaq type PM 3610 C is fitted in the vacuum system between the vacuum controller and injector. The chlorine gas flow is automatically adjusted. A stepper motor controls an ultra-precise V-nozzle, enabling a linear control characteristic over a wide range. Control is by means of external control, such as analogue signals, 0/2 - 10 V, Modbus or by manually setting on the device's keypad. Opening and operating statuses are signalled externally by analogue and digital outputs and by LEDs on the device. In the event of power failure, the valve closes automatically, although mechanical manual operation is possible. The flow of chlorine gas is displayed on a long-scale flow meter and is held constant by the integrated differential pressure regulator even with fluctuating pressure conditions.

Manometers display both the injector vacuum as well as the operating vacuum.

The entire system is ready-wired and mounted on a PVC panel and protected by an appropriate cover.

Your benefits

- Automatic chlorine gas metering
- Plug and Play
- DIN 19606-compliant
- Panel-mounted system
- Wide-ranging controllable motorised control valve
- Functional cover hood

Technical Details

Full-vacuum chlorine gas metering unit type PM 3610 C including:

- motorised control valve PM 3531 C, capacity up to 15 kg/h with C-control nozzle with 1:20 controllability, with automatic proportional metering via a 4-20 mA signal.
- LED indicator for the opening status
- 5-point calibration
- Simple, manual or automatic operation
- Potential-free contact for error signalling
- Long-scale flow meter (165 mm) with a precision of $\pm 4\%$
- Differential pressure controller in accordance with DIN 19606
- Manometer to display the operating vacuum
- Manometer to display the injector vacuum
- Non-return valve on the outlet side
- Power supply: 230 VAC 50/60 Hz
- Degree of protection: IP67
- Pipework: PVC-U PN16
- Vacuum switch (vacuum too high / vacuum too low) (-HL)

Field of application

- Potable water
- Swimming pool
- Waste water
- Cooling water

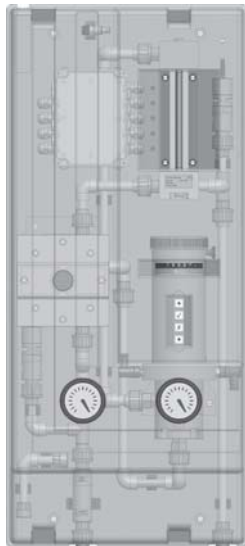

P_DV_0026_SW

NEW

1 Disinfection Systems and Oxidation Systems

Technical Data

Dimensions: 896 x 396 x 210 mm
Weight: 6.5 kg
Vacuum connections: up to 4 kg/h d8/d10
 from 10 kg/h d12/16

	Capacity kg/h	Order no.
Chlorine gas metering system PM3610C/3UDP	0.1	1093120
Chlorine gas metering system PM3610C/4UDP	0.2	1093121
Chlorine gas metering system PM3610C/5UDP	0.5	1082492
Chlorine gas metering system PM3610C/6UDP	1	1082493
Chlorine gas metering system PM3610C/7UDP	2	1082504
Chlorine gas metering system PM3610C/8UDP	4	1082505
Chlorine gas metering system PM3610C/9UDP	10	1083574
Chlorine gas metering system PM3610C/15UDP	15	1083575



1 Disinfection Systems and Oxidation Systems

1.5.8 Chlorine Gas Metering System DULCO®Vaq

Free-standing units for safe chlorine gas metering DULCO®Vaq

Capacity: 20 – 200 kg/h

DULCO®Vaq type PMR540 und 550C – high-performance free-standing unit for precise chlorine gas metering in water treatment

Free-standing unit for automatic or manual metering of large volumes of chlorine gas. Metering is precise and reproducible. Different capacity ranges can be selected. With stable housing made of fibreglass-resistant plastic to protect components.

Your benefits

- Corrosion resistant thanks to epoxy-glass resin housing with reinforced frame
- Positive operational control by vacuum
- Additional safety thanks to vacuum non-return valve
- Precisely adjustable by integral flow meter
- High level of automation by innovative motorised control valve

Technical Details

Components:

- Gas flow meter
- Motorised control valve with automatic metering system (-UDPM)
- Differential pressure controller
- Vacuum display
- Dimensions: 1,500 x 600 x 300 mm (HxWxD)
- Weight: approx. 60 kg

Discharge side:

- flange connection D3/4" NP 16
- DN 20 (DIN 2633) from 20 to 200 kg

Vacuum side:

- 20 kg/h – d20 – 3/4"
- 40 kg/h – d25 – 1"
- 60 kg/h – d50 – 2"
- 80 kg/h – d50 – 2"
- 120 kg/h – d50 – 2"
- 160 kg/h – d50 – 2"
- 200 kg/h – d50 – 2"

Field of application

- Water treatment
- Potable water
- Waste water
- Industry
- Cooling water

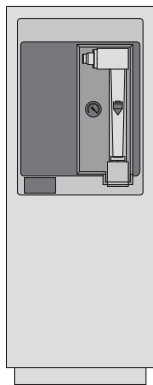

P_DV_0036_SW1



1 Disinfection Systems and Oxidation Systems

Manual free-standing metering units

	Capacity kg/h	Order no.
PMR540C/20UDP 20 kg/h	20	1097561
PMR540C/25UDP 25 kg/h	25	1097562
PMR540C/30UDP 30 kg/h	30	1097563
PMR540C/40UDP 40 kg/h	40	1097584
PMR550C/50UDP 50 kg/h	50	1097585
PMR550C/60UDP 60 kg/h	60	1097587
PMR550C/80UDP 80 kg/h	80	1097588
PMR550C/100UDP 100 kg/h	100	1097589
PMR550C/120UDP 120 kg/h	120	1097590
PMR550C/150UDP 150 kg/h	150	1097591
PMR550C/200UDP 200 kg/h	200	1097592

Automatic free-standing metering units

	Capacity kg/h	Order no.
PMR540C/20UDPM 20 kg/h	20	1097593
PMR540C/25UDPM 25 kg/h	25	1097594
PMR540C/30UDPM 30 kg/h	30	1097595
PMR540C/40UDPM 40 kg/h	40	1097596
PMR550C/50UDPM 50 kg/h	50	1097597
PMR550C/60UDPM 60 kg/h	60	1097598
PMR550C/80UDPM 80 kg/h	80	1097599
PMR550C/100UDPM 100 kg/h	100	1097600
PMR550C/120UDPM 120 kg/h	120	1097601
PMR550C/160UDPM 160 kg/h	150	1097602
PMR550C/200UDPM 200 kg/h	200	1097603



1 Disinfection Systems and Oxidation Systems

1.5.9

Vacuum Switch-Over for Chlorine Gas DULCO®Vaq

Uninterrupted chlorine gas supply by the automatic changeover between chlorine gas storage tanks.

Capacity: 12 g/h to 120 kg/h

Vacuum switches DULCO®Vaq PM 400 and 440 automatically and reliably switch between two chlorine gas storage tanks. They therefore ensure an uninterrupted chlorine gas supply, even if a chlorine gas storage tank becomes empty.

DULCO®Vaq PM 400 and 440 are used where uninterrupted chlorine supply must be ensured. The vacuum switch-over switches to a second connected storage tank in the event of a storage tank becoming empty, solely vacuum-operated and without external auxiliary energy.

Your benefits

- Automatic switchover of chlorine gas sources
- Purely vacuum-operated system without external auxiliary energy
- Simple assembly and commissioning

Technical Details

- 5 capacities up to 120 kg/h
- ABS housing with hose connector for devices up to 10 kg/h
- PVC housing with threaded connector and straight solvent union for units up to 120 kg/h
- Potential-free contacts for the display of the chlorine gas source currently used via an indicator box (optional)

Field of application

- Potable water
- Swimming pool water
- Waste water
- Cooling water

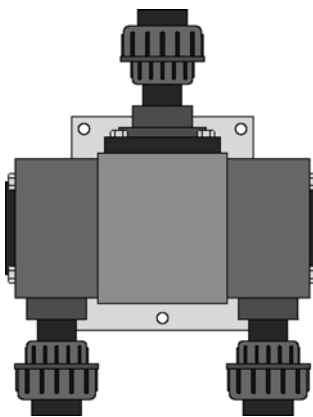

P_DV_0034_SW

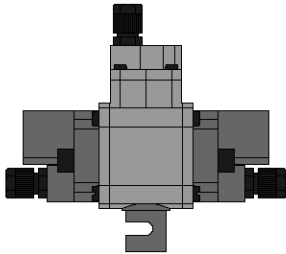

P_DV_0024_SW



1 Disinfection Systems and Oxidation Systems

- 1 Chlorine gas cylinder
- 2 Vacuum metering controller
- 3 Vacuum switch-over
- 4 Vacuum safety valve
- 5 Active carbon filter
- 6 Gas warning sensor
- 7 Heating
- 8 Sprinkler system
- 9 Flashing light and horn
- 10 Automatic chlorine gas metering system
- 11 DULCOMARIN®
- 12 Gas detector
- 13 Process water set
- 14 Injector
- 15 Booster pump
- 16 Injection point

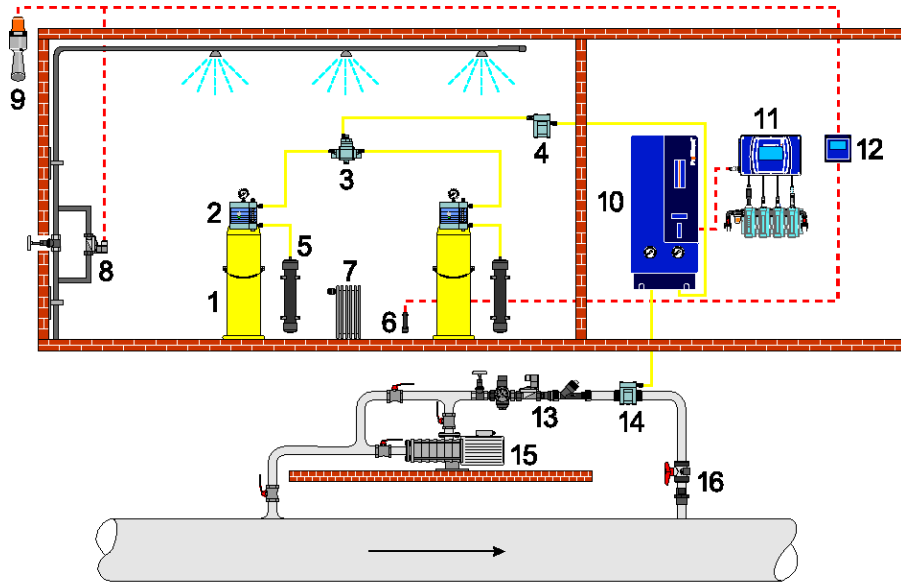

P_DV_0023

Technical Data

Capacity	Hose connector	PVC threaded connector	Electrical contact	Weight	Order no.
kg/h				kg	
4	d8/d10	–	none	0.5	1055838
4	d8/d10	–	with	0.5	1055839
10	d12/d16	–	none	0.5	1060293
10	d12/d16	–	with	0.5	1077183
40	–	d25	none	3.3	1075780
40	–	d32	none	3.3	1077185
40	–	d40	none	3.3	1077187
80	–	d40	none	10.0	1077190
80	–	d50	none	10.0	1077192
120	–	d50	none	10.0	1077195

Indicator box

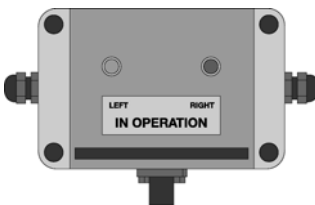

P_DV_0031_SW

Indicator box for connection to the vacuum switch-over. With two LEDs for displaying the active chlorine gas source (Duty/ Standby). Only for use with vacuum switch-over with electrical contact.

Power connection: 24 V DC
Degree of protection: IP 65
Dimensions: 140 x 80 mm

Indicator box	Order no.
Indicator box PM3290 C	1082815



1 Disinfection Systems and Oxidation Systems

1.5.10

Pressure Switch-Over for Chlorine Gas DULCO®Vaq

Pressure switch-over for the consistent supply of chlorine gas

Capacity range of up to 200 kg/h

DULCO®Vaq pressure switch-over type PM 481 for continuous chlorine gas supply with high capacities.

The DULCO®Vaq pressure switch-over ensures a constant supply of liquid or gaseous chlorine to the system. It guarantees secure and reliable switchover between two chlorine storage containers. The pressure switch-over consists of two electrical motorised valves, one or two pressure sensors and one proprietary control. Depending on the pressure detected, the valves switch fully automatically from an empty to a full chlorine storage tank.

Your benefits

- Safe handling by means of automatic operation and pressure monitoring
- Continuous operating thanks to uninterrupted supply of chlorine gas
- Simple operation
- Simple connection thanks to control supplied

Technical Details

Components:

- Motorised valves
- Pressure switch
- Connecting flanges
- Electronic control

Field of application

- Potable water
- Waste water
- Industry
- Swimming pools

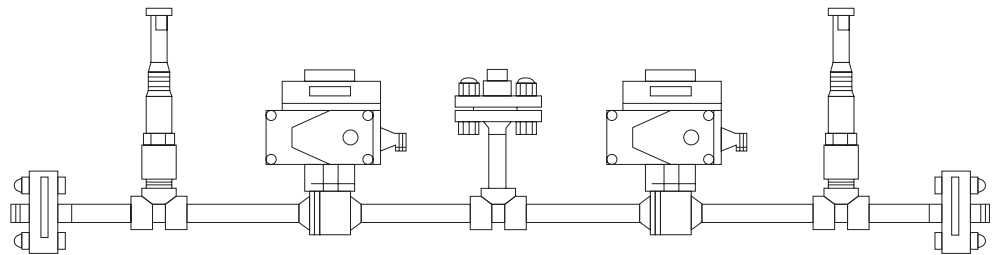

P_DV_0032_SW

	Order no.
Cl ₂ switch-over PM481C 200 kg/h, DN 25, 230 V	1082814
Cl ₂ switch-over PM481C 50 kg/h, DN 25, 230 V	1082733
Cl ₂ switch-over PM481C/1 200 kg/h, DN 25	1097855
Cl ₂ switch-over PM481C/1 50 kg/h, DN 25	1097854
Cl ₂ switch-over PM481C/2 200 kg/h, DN 25	1097833
Cl ₂ switch-over PM481C/2 50 kg/h, DN 25	1096756

1



1 Disinfection Systems and Oxidation Systems

1.5.11 Injector for Chlorine Gas DULCO®Vaq

Stable vacuum for safe metering

Capacity: 12 g/h to 200 kg/h

Injectors for chlorine gas, series DULCO®Vaq, generate a stable vacuum even at high operating pressures.

A defined vacuum, adapted to the operating statuses and performance requirements, is required to meter chlorine gas safely and on-demand. DULCO®Vaq injectors for capacities ranging from a few grammes to 200 kg/h offer a range for all operating pressures.

Your benefits

- Safe vacuum generation
- Up to 40 bar back pressure
- Integrated non-return valve
- Versatile installation models
- Durable housing

Note: Injector curves are available for all of the models for selecting suitable booster pumps.

Field of application

- Potable water
- Swimming pool water
- Waste water
- Cooling water

Note: Injector curves are available for all of the models for selecting suitable booster pumps.



P_DV_Injector

Type PM 306, standard with PVC threaded connector, water inlet PVC screw connection DN20 (d25), water outlet PVC screw connection DN20 (d25)

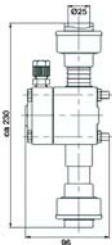

P_DV_0014_SW

Capacity kg/h	Connector on the vacuum side	Order no.
0.2	d8/d10	1055831
0.5	d8/d10	1055832
1.0	d8/d10	1055833
2.0	d8/d10	1055834
4.0	d8/d10	1055835

Type PM 305, standard with R5/4"

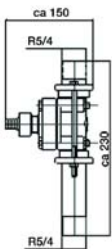

P_DV_0015_SW

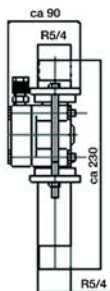

P_DV_0016_SW

Capacity kg/h	Connector on the vacuum side	Order no.
4.0	d8/d10	1077174
10.0	d12/d16	1060290
15.0	d12/d16	1077175



1 Disinfection Systems and Oxidation Systems

1

Type PM 300, with immersion pipe R3/4", pressure < 6 bar, water inlet R3/4", water outlet R3/4"

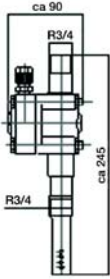

P_DV_0017_SW

Capacity kg/h	Connector on the vacuum side	Order no.
0.2	d8/d10	1055822
0.5	d8/d10	1055823
1.0	d8/d10	1055824
2.0	d8/d10	1055825
4.0	d8/d10	1055826

Type PM 301, reinforced for pressure up to 20 bar, water inlet DN 32 (1 1/4"), water outlet DN 32 (1 1/4")

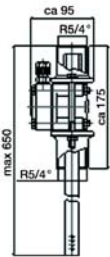

P_DV_0018_SW

Capacity kg/h	Connector on the vacuum side	Order no.
0.2	d8/d10	1055827
0.5	d8/d10	1055828
1.0	d8/d10	1055829
2.0	d8/d10	1055830

Type PM 340, flange DN 50, water inlet DN 50 (2"), water outlet DN 50 (2")

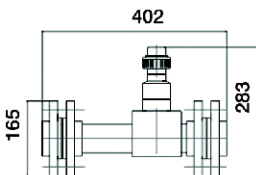

P_DV_0019_SW

Capacity kg/h	Connector on the vacuum side	Order no.
20.0	d20/d25/d32/d40	1077176
40.0	d20/d25/d32/d40	1077177

Type PM 350, flange DN 80, for pressure < 6 bar

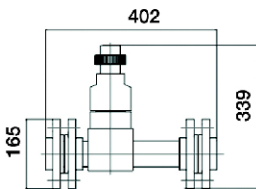

P_DV_0020_SW

Capacity kg/h	Water inlet	Water outlet	Connector on the vacuum side	Order no.
60	DN 80 (3")	DN 80 (3")	d32/d40/d50	1077178
80	DN 80 (3")	DN 80 (3")	d32/d40/d50	1077179
120	DN 80 (3")	DN 80 (3")	d32/d40/d50	1077180
160	project-specific	project-specific	–	1077181
200	project-specific	project-specific	–	1077182



1 Disinfection Systems and Oxidation Systems

1.5.12 Flow Meter for Chlorine Gas DULCO®Vaq

Flow meter for chlorine gas with which the chlorine gas flow can be adjusted by the integral control valve. The chlorine gas flows through the measuring cylinder from the bottom to the top and a float indicates the chlorine flow on the scale.

The flow meters consist of a base plate, surrounds for the measuring cylinder, a measuring cylinder and the control valve. The size of the flow meter is based on the flow of chlorine gas required. The capacity ranges from 12 g/h to 200 kg/h.

The integral control valve and the measuring cylinder are designed for maximum precision.

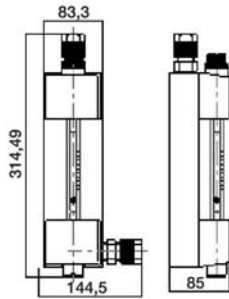

P_DV_0021_SW

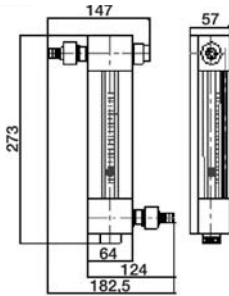

P_DV_0022_SW

Capacity kg/h	Hose connector	PVC threaded connector	Order no.
0,012	d8/d10	–	1055798
0,025	d8/d10	–	1055800
0,1	d8/d10	–	1055801
0,2	d8/d10	–	1055802
0,5	d8/d10	–	1055803
1	d8/d10	–	1055804
2	d8/d10	–	1055805
4	d8/d10	–	1055806
10	d12/d16	–	1060291
20	–	d20	1077158
40	–	d25	1077159
60	–	d32	1077160
80	–	d32	1077161
120	–	d32	1077162
160	–	d40	1077163
200	–	d50	1077164

Long-scale flow meter

Gas flow meter C12, 10 x 8 mm connector, 174 mm length

Capacity kg/h	Hose connector	Length mm	Order no.
0,1	d8/d10	174	1093100
0,2	d8/d10	174	1093101
0,5	d8/d10	174	1093102
1	d8/d10	174	1093103
2	d8/d10	174	1093114

Maintenance kit

	Length mm	Order no.
Maintenance kit for flow meter ≤ 4 kg/h	174	1093115



1 Disinfection Systems and Oxidation Systems

1.5.13

Automatic Emergency Shut-Off System for Chlorine Gas DULCO®Vaq

Emergency shut-off system for chlorine gas – the new safety for your system

Automatic closure of chlorine gas valves in seconds.



The electrical Emergency Stop system provides additional safety for personnel and equipment by automatically closing off the chlorine gas supply. With its own operating unit and uninterrupted power supply, it reliably closes the chlorine gas valves in the event of an emergency, even following power failure.

The DULCO®Vaq emergency shut-off system for chlorine gas, coupled with a chlorine gas detector, ensures the automatic and immediate closure of the chlorine gas source in the event of a leak.

The actuator sits directly on the chlorine gas valve of each storage tank and is controlled by an operating unit. This transmits the signal to close as soon as the chlorine gas detector detects a leak. The emergency shut-off system then closes the storage tanks within a few seconds. All the back pressure connections to the vacuum regulator are thus closed preventing the escape of more chlorine gas. The emergency shut-off system can also be manually triggered by an emergency stop switch fitted outside the storage room. The operator must manually re-open the chlorine gas valves after cordoning off the surroundings and rectifying a possible leak.

Your benefits

- Closes directly at the valve
- Closes all kinds of chlorine gas valves within seconds in the event of an emergency
- Electrically operated and equipped with an uninterrupted power supply (UPS)
- Adjustable torque for secure closure
- System-independent retrofitting of existing chlorine gas systems
- Simple assembly and dismantling when changing storage tanks without the need for tools
- Virtually maintenance-free
- Chlorine detector can be supplied via the integral UPS
- Suitable for almost all types of valve (chlorine gas cylinders and drums)

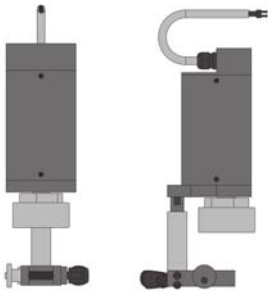

P_DV_0003_SW

Technical Details

Actuators

- Temperature range: -10 °C...50 °C
- Fuse: 2 A
- Power consumption: max. 600 VA
- Relay output: 230 V, 3 A, inductive resistance 8 Ω
- Actuator torque: 3 ... 7 Nm (dynamic) when the valve is closing
- Degree of protection: IP 54
- Connector: 10 m connecting cable in the scope of delivery
- Weight: 1.5 kg
- Wall bracket in the scope of delivery

Operating unit

- Supply voltage: 230 V, 50/60 Hz
- Nominal power: 600 VA
- Battery (UPS): up to 8 hours stand-alone operation
- Inputs: 2
- Outputs: 2
- Degree of protection: IP 66
- Transformer for power supply to the actuators
- Adjusting the torque
- Input relay for signal from the gas detector
- Switch for manual shut-off of the chlorine gas sources

Field of application

- Potable water
- Swimming pool water
- Waste water
- Cooling water

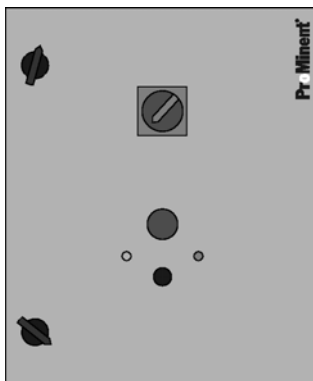
bedieneinheit
Operating unit

1 Disinfection Systems and Oxidation Systems

Actuators



P_DV_0044_1
Manual adjustment wheel (order no. 1082413)

	Order no.
Actuator for valves with manual adjustment wheel (VTI) with a simple leg	1082413
Actuator with quick-release clamp for valves with square valve stem (9.5 x 9.5 mm)	1077243
Actuator with quick-release clamp for valves with manual adjustment wheel (VTI) for gas bottle and drum valves	1077242
Actuator for valves with yoke connection	1083832
Actuator with valves with square valve stem (9.5 x 9.5 mm)	1098281



P_DV_0044_2
Manual adjustment wheel with quick-release clamp (order no. 1077242)

Operating units

- Supply voltage: 230 V 50/60 Hz
- Power consumption: 600 VA
- Battery: up to 8 hours autonomous operation
- Inputs: 2
- Outputs: 2
- Protection class: IP 66



P_DV_0044_3
Four-sided adapter (order no. 1098281)

	Number of actuators	Dimensions H x W x D mm	Weight kg	Order no.
PM3800/2 for 2 actuators	2	630 x 400 x 265	18	1082409
PM3800/6 for up to 6 actuators	6	630 x 500 x 265	20	1077244
PM3800/10 for up to 10 actuators	10	630 x 600 x 265	25	1082411
PM3800/12 for up to 12 actuators	12	830 x 600 x 335	28	1095205



P_DV_0044_4
Four-sided adapter with quick-release clamp (order no. 1077243)



P_DV_0044_5
Four-sided (9.5 x 9.5 mm) with Y-fork (order no. 1083832)



1 Disinfection Systems and Oxidation Systems

1.5.14

Evaporator for Chlorine Gas DULCO®Vaq

Evaporator for chlorine gas DULCO®Vaq converts liquid into gaseous

Capacity range 50 – 200 kg/h

Evaporator DULCO®Vaq type PM3100C – for liquid chlorine applications and large chlorine gas systems – safe and reliable.

Gaseous extraction is no longer possible with applications with a large chlorine requirement. The evaporator DULCO®Vaq is used here. It warms the liquid chlorine in a controlled way after extraction from the storage tank and changes it to a gaseous state. It therefore enables the handling of large volumes of chlorine.

Your benefits

- Safe handling of large chlorine volumes of gas
- Reliable water bath evaporator
- Simple installation
- Long service life due to cathodic corrosion inhibition
- High level of automation
- Durable housing

Technical Details

- Power supply: 400 V 50/60 Hz
- Connected power: 9 – 18 kW
- Test pressure: 20 bar
- Working temperature 70 °C
- Working pressure chlorine gas max. 16 bar; water max. 8 bar
- Proprietary control
- Insulated warming chamber
- Pressure display
- Temperature display
- Epoxy-glass resin housing
- Leakage detection
- Gas connector: DN 15 NP 40
- Gas outlet: DN 20 NP 40
- Water connection: R 3/4"
- Dimensions (LxWxH): 600x450x1,500 mm
- Weight: approx. 115 kg (operating weight)

Field of application

- Use of liquid chlorine with high extraction volumes
- For the disinfection of large volumes of water in water works
- Industrial applications in cooling and process water



P_DV_0037_SW1

	Capacity	Connected load	Order no.
	kg/h	kW	
Evaporator PM3100C / 50	50	4	1097544
Evaporator PM3100C / 100	100	8.5	1097546
Evaporator PM3100C / 150	150	15	1097547
Evaporator PM3100C / 200	200	18	1097548



1 Disinfection Systems and Oxidation Systems

1.5.15 Neutraliser for Chlorine Gas DULCO®Vaq



Safety in the chlorine gas room with the neutraliser DULCO®Vaq

Neutralisation of 50 – 500 kg of chlorine gas

Neutraliser DULCO®Vaq reliably draws escaped chlorine gas in the event of an alarm with the room air from the chlorine gas room and reliably neutralises it.

Neutraliser for chlorine gas DULCO®Vaq in the event of a gas leak. It protects staff and equipment in the chlorine gas room in the event of a leak. A water jet pump draws the contaminated air from the chlorine gas room and neutralises it simultaneously. The purified air is routed from the building. The neutraliser is automatically triggered if a leak is detected or is manually started.

Your benefits

- Neutralises chlorine gas in the event of a leak
- 99.9% neutralisation in the water jet pump
- Safety and protection of the equipment
- Automatic operation
- Simple handling and maintenance

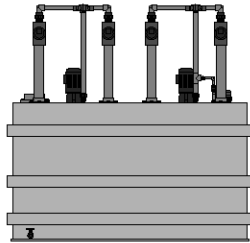

Technical Details

- Tank for neutralisation solution
- Special high-resistant pump
- High-performance water jet pump for high suction capacity

Field of application

- Water treatment
- Potable water
- Waste water
- Swimming pools

P_DV_0006_SW

Technical Data

	Capacity	Connected load	Suction capacity	Tank volume	Order no.
	kg/h	kW	m³/h	l	
PM3100C / 50	50	2.2	150	900	on request
PM3100C / 100	100	2.2	150	1,800	on request
PM3100C / 200	200	2.2	300	3,600	on request
PM3100C / 300	300	2.2	300	5,400	on request
PM3100C / 400	400	4.4	600	7,200	on request
PM3100C / 500	500	4.4	600	9,000	on request



1 Disinfection Systems and Oxidation Systems

1.5.16 Accessories for Chlorine Gas Metering

Active carbon absorption tank

Absorption storage tank for chlorine gas with active carbon filling.

For the connection to the safety vent of the vacuum regulator.

	Order no.
Active carbon filter	1055840
Replacement filling (3 kg)	1075273

Vacuum safety valve

The vacuum safety valve PM 3903 according to DIN 19606 is used to protect the installation from the possible build-up of pressure in the vacuum line.

	Order no.
Vacuum safety valve, 4 kg/h, d20 threaded connector	1103039
Vacuum safety valve, 4 kg/h, 10 x 8 mm connector	on request
Vacuum safety valve, 15 kg/h, 16 x 12 mm connector	1082417
Maintenance kit for vacuum safety valve PM3903 4 kg/h	1096390
Maintenance kit for vacuum safety valve PM3903 15 kg/h	1096391

Vacuum line

Vacuum-resistant PE hose material to connect up the components in the chlorine gas metering system.

	Order no.
Hose PE-LD d8/d10	1055837
Hose PE-LD d12/d16	1077236
T-hose connector d12/d16 to d8/d10	1095446
L-hose connector d12/d16 to d8/d10	1095447

Vacuum shut-off valve

Manual shut-off valve PVC-U for installation in the vacuum line.

	Order no.
Cl ₂ vacuum shut-off valve d10x8	1056321
Cl ₂ vacuum shut-off valve d16x12	1056322

Chlorine gas non-return valve PM3901

Mechanical non-return valve for the vacuum line. As additional backup against the ingress of water from the injector into the chlorine gas metering system.

	Order no.
Non-return valve 10x8 PVC-U	1055836
Non-return valve 15 kg/h 16x12 PVC-U	1075781
Non-return valve 40 kg/h DN 25 PVC-U	1077240
Non-return valve 120 kg/h DN 50 PVC-U	1077241

Differential pressure regulator

The differential pressure regulator adjusts any fluctuations within the vacuum before and after the rate valve and ensures constant metering. Complies with DIN 19606.

	Flow kg/h	Connector	Order no.
Differential pressure regulator PMDP20	4	10x8	1077165
Differential pressure regulator PMDP20	4... 10	16x12	1077167
Differential pressure regulator PMDP20	15	d20	1077168
Differential pressure regulator PMDP40	20	d20	1077169
Differential pressure regulator PMDP40	40	d25	1077170
Differential pressure regulator PMDP50	80	d40	1077171
Differential pressure regulator PMDP50	120	d50	1077172



1 Disinfection Systems and Oxidation Systems

Injection lance



To feed the chlorinated water from the injector bypass into the main water line. With a PVC lance, which can be cut to the corresponding pipe diameter.

	Connector	Order no.
Cl ₂ injection lance PVC-U	DN 20	1056317
Cl ₂ injection lance PVC-U	DN 25	1056318
Cl ₂ injection unit PVC-U	DN 32	1056319
Cl ₂ injection lance PVC-U	DN 40	1056320

Water Inlet Assemblies

Water inlet assembly for installation in the water line to the injector. Protects the injector nozzle from dirt thanks to the filter insert integrated in the pressure reducer. Displays the injector pressure. Maximum priming pressure 10 bar.

The following fittings can be selected:

- A – Manual shut-off valve
- D – Pressure reducer with manometer and filter insert; brass
- M – Solenoid valve 24 or 230 V AC; brass
- R – Non-return valve, PVC-U

	Order no.
Water inlet assembly ADR G3/4"	1082170
Water inlet assembly ADR G1	1082303
Water inlet assembly ADR G1 1/4"	1082334
Water inlet assembly ADR G1 1/2"	1082335
Water inlet assembly ADM G3/4" 24 V AC	1082336
Water inlet assembly ADM G1" 24 V AC	1082337
Water inlet assembly ADM G 1/4" 24 V AC	1082338
Water inlet assembly ADM G 1/2" 24 V AC	1082339
Water inlet assembly ADM G3/4" 230 V AC	1082340
Water inlet assembly ADM G1" 230 V AC	1082341
Water inlet assembly ADM G 1/4" 230 V AC	1082342
Water inlet assembly ADM G 1/2" 230 V AC	1082343
Water inlet assembly ADMR G3/4" 24 V AC	1082344
Water inlet assembly ADMR G1" 24 V AC	1082345
Water inlet assembly ADMR G 1/4" 24 V AC	1082346
Water inlet assembly ADMR G 1/2" 24 V AC	1082347
Water inlet assembly ADMR G3/4" 230 V AC	1082348
Water inlet assembly ADMR G1" 230 V AC	1082349
Water inlet assembly ADMR G 1/4" 230 V AC	1082350
Water inlet assembly ADMR G 1/2" 230 V AC	1082351

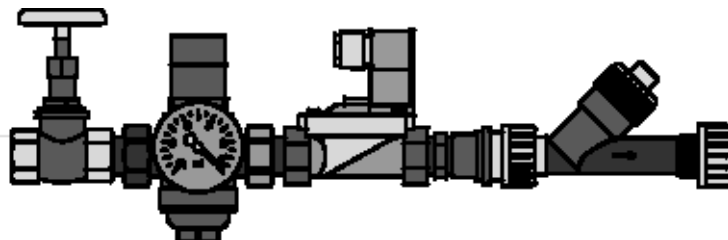

P_DV_0027_SW



1 Disinfection Systems and Oxidation Systems

Wall adapter for chlorine gas cylinders and chlorine gas drum

To wall mount the vacuum controller with semi-vacuum systems. Inclusive of flexible copper cable, connector valve and liquid trap.

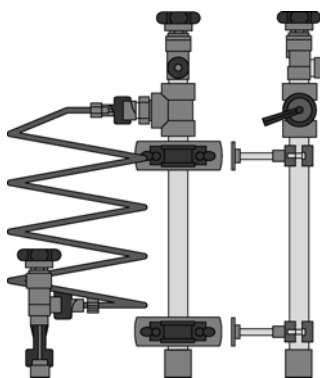

P_DV_0028_SW

	Connection	Order no.
Wall adapter for chlorine gas bottles PM3311	left	1059787
Wall adapter for chlorine gas bottles PM3311	right	1059789
Wall adapter for chlorine gas drum PM3312	left	1060304
Wall adapter for chlorine gas drum PM3312	right	1060308

Chlorine gas manifold

Chlorine gas manifold for the connection of multiple chlorine gas tanks to a common main line (for gaseous or liquid chlorine).

Chlorine gas manifold consisting of (quantities depending on the number of chlorine canisters):

- Main manifold line
- Manifold valves
- Flexible copper pipe
- Shut-off valves

	for connecting multiple cylinders	Connection	Order no.
Chlorine gas cylinder manifold PM3302 1"	2	left	1082573
Chlorine gas cylinder manifold PM3302 1"	2	right	1082584
Chlorine gas bottle manifold PM3303 1"	3	left	1082585
Chlorine gas bottle manifold PM3303 1"	3	right	1082586
Chlorine gas bottle manifold PM3304 1"	4	left	1082588
Chlorine gas bottle manifold PM3304 1"	4	right	1082589
Chlorine gas bottle manifold PM3305 1"	5	left	1082590
Chlorine gas bottle manifold PM3305 1"	5	right	1082591
Chlorine gas bottle manifold PM3306 1"	6	left	1082592
Chlorine gas cylinder manifold PM3306 1"	6	right	1082593

	for connecting multiple drums	Connection	Order no.
Manifold for chlorine gas drum PM3322 1"	2	left	1075771
Manifold for chlorine gas drum PM3322 1"	2	right	1075772
Manifold for chlorine gas drum PM3323 1"	3	left	1082596
Manifold for chlorine gas drum PM3323 1"	3	right	1082597
Manifold for chlorine gas drum PM3324 1"	4	left	1082598
Manifold for chlorine gas drum PM3324 1"	4	right	1082599
Manifold for chlorine gas drum PM3325 1"	5	left	1082600
Manifold for chlorine gas drum PM3325 1"	5	right	1082601
Manifold for chlorine gas drum PM3326 1"	6	left	1082602
Manifold for chlorine gas drum PM3326 1"	6	right	1082603

Note: The right and left side of the manifold must be ordered if a switch-over is used.

Heating kit

Self-limiting heating band whose heat output decreases as the temperature rises. Output 15 W/m. incl. terminal kit and temperature sensor Pt100, length 10 m.

	Order no.
Complete heating set for chlorine gas manifold, 230 V	1082707



1 Disinfection Systems and Oxidation Systems

1.5.17 Accessories for Room and Safety Equipment

Chlorine gas cylinder support bracket

Wall-mounted galvanised steel U-profile to secure the chlorine gas cylinders from toppling over. With adjustable chain length.

	Order no.
Wall bracket for chlorine gas cylinder	1058803

Wall bracket for vacuum controller

For the safe storage of the vacuum controller when changing bottles.

	Order no.
Wall bracket for vacuum controller, plastic	1058804
Wall holder for yoke connector, galvanised steel	1079251

Gas detector Neon® Gas Chlorine Gas

The gas detector type Neon® Gas Chlorine Gas is designed as a compact measuring and switching unit for monitoring the ambient air for dangerous concentrations of chlorine gas.

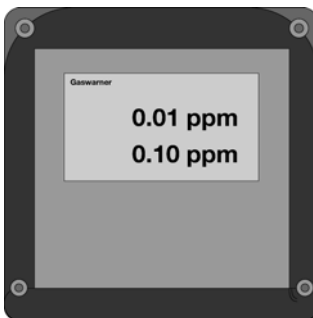

P_DV_0030_SW

Technical Data

Type	Chlorine gas
Warning at approx.	0.3 ppm/vol%
Alarm at approx.	0.5 ppm/vol%
Permissible ambient temperature	0...50°C
Protection class housing	IP 65
Dimensions (without PGs, without sensor) H x W x D	144 x 144 x 156 mm
Supply	85 – 265 V / 50 – 60 Hz
Power consumption	10 W
Warm-up phase max.	150 s
"Warning" relay contact, self-resetting	250 V ; 6 A
"Alarm" relay contact, latching	250 V ; 6 A
"Horn" relay contact, latching, can be acknowledged	250 V ; 6 A
Sensor measuring principle	amperometric
Sensor service life (depending on ambient conditions)	1Year

Note: The sensor reacts to all oxidising gases.

	Order no.
Gas detector neon® Cl ₂ 1 sensor	1083162
Gas detector neon® Cl ₂ 2 sensors	1083163
Chlorine gas spare sensor zircon 20 ppm	1104352

Bracket and 10 m cable in the scope of delivery

Flash light-horn

Combined horn and red warning lamp. IP 65 housing made of impact-resistant grey polycarbonate with a transparent polycarbonate dome. Rating values: 230 V AC, 50 mA.



	Order no.
Flash light-horn, red with continuous tone	1083160



1 Disinfection Systems and Oxidation Systems

Combination emergency shower

Emergency shower made of EXP-18GS/45G (DVGW) stainless steel for use indoors. With DVGW certification. The body shower is actuated by a pull rod lever. Includes eye shower.

Connector: 1 1/4" female thread

Dimensions (approx.): (DxWxH) 750 x 340 x 2,300 mm

	Order no.
Combination emergency shower EXP-18GS/45G (DVGW)	1041245

BasicLine emergency shower with sign

BasicLine body shower with eye shower, floor-mounted.

Water connection: 1 1/4" female thread

Radius: 640 mm

Overall height: 2,270 mm

	Order no.
BasicLine emergency shower with information sign	1082512

Floor actuation for BasicLine emergency shower

Floor actuation for industrial emergency showers in addition to the pull rod.

Material: Plastic grille with stainless steel frame

	Order no.
Floor actuation for BasicLine emergency shower	1082513

Condensation heater PM3003

For installation on the dripleg.

	Order no.
Condensation heater PM3003 10 W 220 V AC / 24 V DC	1075198

Complete set of signs for chlorination systems

Complete set of signs for chlorine gas room – inside (plastic) and outside (aluminium)

	Order no.
Complete set of signs for chlorination systems, German	1078436
Complete set of signs for chlorination systems, English	1078437



1 Disinfection Systems and Oxidation Systems

Empty/Full chlorine bottle sign with chain

Engraved reversible plate with stainless steel chain.

- Dimensions: 175 x 50 mm

	Order no.
Empty/Full chlorine bottle sign with chain	1082101

Emergency equipment

To safeguard against leakages in the valve area or wall area of the chlorine gas storage tank in an emergency. For the wall area with pressure plate, clamping block and unclamping mechanism with chains. For the valve area with protective cap with flange valve and unclamping mechanism with chains.

	Order no.
Emergency equipment 65 kg for chlorine gas bottles in valve area	1082100
Emergency equipment 50 kg for chlorine gas bottles in valve area	1082183
Emergency equipment 500 kg for chlorine gas drums in wall area	1082184
Emergency equipment 1,000 kg for chlorine gas drums in wall area	1082185
Chlorine Institute Kit "A" emergency equipment for chlorine gas bottles	1082265
Chlorine Institute Kit "B" emergency equipment for chlorine gas drums	1082167

Sprinkler system for the chlorine gas room

According to BGR/GUV-R 108, chlorine gas rooms must be equipped with a chlorine gas removal facility, with which the escaping chlorine gas can be harmlessly and effectively removed.

The sprinkler system consists of a main shut-off valve, a bypass and spray jets. The main shut-off valve with the bypass is fully ready mounted as a unit. The bypass consists of two manual shut-off valves and a solenoid valve. The spray jets are also ready mounted as units in two different designs.

Any escaping chlorine gas can be directly neutralised with additional metering of thiosulfate in the sprinkler system.



P_DV_0043_2

	Order no.
Sprinkler system without nozzle DN 20 PVC-U 230 V AC	1082605
Sprinkler system without nozzle DN 32 PVC-U 230 V AC	1082606
Spray nozzle, complete L90° DN 20 PVC-U	1082607
Spray nozzle, complete L90° DN 32 PVC-U	1082608
Spray nozzle, complete T90° DN 20 PVC-U	1082609
Spray nozzle, complete T90° DN 32 PVC-U	1082610
Stirring tank DULCO®VaQ 250 l pen DN 20	1095236
Metering set, complete, thiosulphate for 2 nozzles	1096300
Metering set, complete, thiosulphate for 3 nozzles	1096301
Metering set, complete, thiosulphate for 4 nozzles	1096302
Metering set, complete, thiosulphate for 5 nozzles	1096303
Metering set, complete, thiosulphate for 6 nozzles	1096304



1 Disinfection Systems and Oxidation Systems

1.5.18

Other Accessories

Wall fans

Wall-mounted axial ventilators for ventilation of chlorine gas chamber. DN 500 with quadratic mounting plate and automatic cover flap.

	Output m ³ /h	Order no.
Wall fan 400 V 50 Hz	5,800	1082412
Wall fan 400 V 50 Hz	2,500	1082410
Wall fan 400 V 50 Hz	1,150	1082408

Chlorine gas storage tank

High-grade safety-tested chlorine gas storage tank for use as original equipment or spare part. Supplied empty without chlorine gas.

	Volume l	Order no.
Chlorine gas storage tank P355NL1 EN14208	400	1082164
Chlorine gas storage tank P355NL1 EN14208	840	1082165
Steel bottle, 35 bar test pressure, standard taper, welded	52	1082133

Weighing systems and drum storage

To monitor and check the liquid level of chlorine gas bottles and drums. Barrel storage for the safe storage and alignment of the chlorine gas drums.

	Order no.
Electrical bottle scales GR100K-1 1 x 150 kg	1082138
Electrical bottle scales GR100K-2 2 x 150 kg	1082139
Hydraulic bottle scales 4D100K-1 1 x 150 kg	1082140
Hydraulic bottle scales 4D100K-2 2 x 150 kg	1082141
Drum scales DR20K 2,000 kg with electronic display	1082136
Drum scales DR40K 4,000 kg with electronic display	1082415
Drum scales 8D20K 2,000 kg with hydraulic display	1082564
Drum scales 8D40K 4,000 kg with hydraulic display	1082565
Steel bottle, 35 bar test pressure, standard taper, welded	1082135
Drum pallet, galvanised steel	1082166

Crane beam and crane scales

For the safe transport and loading of chlorine gas drums up to max. 2 tonnes.

	Order no.
Crane beam for drum length 2,022–2,076 mm steel	1082137
Chain hoist HZE020 2,000 kg 3,0 m	1082294
Digital crane scales 3,000 kg IP67 230 V SS	1082295
Electrical chain hoist 2,000 kg 400 V 50 Hz IP55	1082296
Chain container BD4 for 4 m chain length	1082297
Cable trolley for power supply, width 132 mm	1082298

1 Disinfection Systems and Oxidation Systems

Reaction tower with granulated marble

During the chlorination of water, hydrochloric acid, which lowers the pH value of the water, is also produced alongside the hypochlorous acid, which has an excellent disinfection effect. If there is insufficient carbonate hardness in the water, the buffer capacity is inadequate and can be replaced in the form of reaction towers with granulated marble.

Filter storage tank made of glass fibre-reinforced epoxy resin with a seamless ABS inner liner

- Operating pressure: max. 10 bar
- Operating temperature: max. 50 °C
- Volume: 170 or 310 litres

	Order no.
Reaction tower HClO 170 l 10 bar epoxy/PE	1082168
Reaction tower HClO 310 l 10 bar epoxy/PE	1082169
Filter material CaCO ₃ 4.0 – 6.0 mm unit kg	1082544



1 Disinfection Systems and Oxidation Systems

1.5.19 Personal Safety Equipment

Full face mask Dräger X-Plore 6300

Efficient and cost-effective full protection respiratory mask without filter made from EPDM and a viewing panel made from scratchproof PMMA for a 180° wide-angle view.

	Order no.
Dräger full mask XP 6300 EN136 class 2	1082117

Dräger X-plore breathing filter

For full mask XP 6300. Specifically suitable for use in chlorine gas systems.

	Order no.
Dräger X-plore breathing filter Rd40 940A2B2 EN143	1082118

Safety boots

Water-tight and slip-resistant.

	Order no.
Safety boots, yellow Size 45 PVC S5 SRA	1082122

Acid apron

	Order no.
Acid apron 100 x 120 cm PVC with fabric; black	1082123

Compressed air breathing apparatus, Diablo Rina 1800 Marine

- Back carrier panel with belt strap carrier
- Overpressure breathing regulator
- Pressure reducer with safety valve
- Manometer
- Acoustic warning device
- including full mask C607/SPA (Class 3) with screw connector M45x3 (DIN EN 148-3)
- including compressed air cylinder (6 l, 300 bar) steel
- Operating period approx. 45 minutes (1800 l breathing air)

	Order no.
Compressed air breathing apparatus, Diablo Rina 1800 Marine	1082124

Compressed air cylinder

As replacement cylinder for compressed air breathing apparatus Diablo Rina 1800 (order no. 1082124).

	Order no.
Compressed air cylinder 6 litres – 300 bar steel	1082173

Protective gloves

	Order no.
Protective gloves 640 PVC, Size10 Cat.3	1082126



1 Disinfection Systems and Oxidation Systems

Chemical suit VS5 Polyran-L

One-part complete full-body chemical protective suit with fixed visor; gas-tight chemical protective suite with breathing air supply carried in the suit independent of the ambient air, i.e. a storage device with compressed air. Inclusive of gloves and safety boots.

Re-usable, washable, very good mechanical properties (tear-resistant, wear-resistant, puncture-resistant).

Certification: DIN EN 943 Part 1 –1a (Industry)

	Order no.
Chemical suit VS5 Polyran-L, yellow	1082509



1 Disinfection Systems and Oxidation Systems



2 Metering Systems

2.1 Polymer Preparation and Metering Systems Ultromat®, PolyRex and POLYMORE

2.1.1 Polyelectrolytes in Water Treatment

The use of polyelectrolytes as flocculation aids is characterised by an extensive field of applications. They can be used in all applications where colloidal solids need to be economically separated from liquids.

Our preparation and metering systems have been designed specifically for the production of ordinary or standard solutions of synthetic polyelectrolytes in powdered or liquid form and have proved themselves many times over.

The experts in waste water treatment at ProMinent understand how to provide the efficient technology to implement this specialist application. They have developed systems for the most stringent requirements, which are also very easy to assemble and operate.

ProMinent also provides all the advice needed for the efficient operation of a polymer batching and metering system:

- Evaluation of the situation on site by trained, expert field sales staff.
- Project planning of the system.
- Commissioning and system maintenance by our trained service technicians.



2 Metering Systems

2.1.2 Performance overview of polymer batching and metering systems Ultromat® and PolyRex

ProMinent offers a wide range of systems for the most diverse batching and metering applications. The following overview shows the capacity ranges of our type series:

Continuous flow system

	Extraction rate l/h concentration max. 0.5 %	Application	Characteristic
ULFa <ul style="list-style-type: none"> ■ powder ■ liquid 	400 – 8,000 (maturation period 60 min., starts with batching mode)	<ul style="list-style-type: none"> ■ Potable water treatment ■ Waste water treatment (industry and local authorities) ■ Sludge de-watering 	<ul style="list-style-type: none"> ■ Simple screw feeder with good dosing precision proportional to the water supply ■ Functionally simple mixing system with/without wetting cone ■ PP storage tank, 3-chamber design

Batch preparation stations

	Extraction rate l/h concentration max. 0.5 %	Application	Characteristic
ULDa <ul style="list-style-type: none"> ■ powder ■ liquid 	400 – 2,000 (maturing time 60 min., starts with batching mode)	<ul style="list-style-type: none"> ■ Potable water treatment ■ Waste water treatment (industry and local authorities) ■ Sludge de-watering ■ Paper production 	<ul style="list-style-type: none"> ■ Simple screw feeder with good dosing precision proportional to the water supply ■ Functionally simple mixing system with/without wetting cone ■ PP storage tank, double-decker design
PolyRex <ul style="list-style-type: none"> ■ powder ■ liquid 	240 – 8,200 (maturation period 45 min., starts after metering)	<ul style="list-style-type: none"> ■ Potable water treatment ■ Waste water treatment (industry and local authorities) ■ Sludge de-watering ■ Paper production 	<ul style="list-style-type: none"> ■ Multi-screw feeder with high dosing precision ■ Special flushing system with water ejector for effective powder hydration ■ Stainless steel tanks, double-decker design ■ Integrated Big Bag emptying system
PolyRex Liquid <ul style="list-style-type: none"> ■ liquid 	1,060 – 3,180 (maturation period 15 min., starts after metering)	<ul style="list-style-type: none"> ■ Waste water treatment (industry and local authorities) ■ Sludge de-watering 	<ul style="list-style-type: none"> ■ High-energy mixing ■ Stainless steel tanks
MT <ul style="list-style-type: none"> ■ powder 	140 – 4,000	<ul style="list-style-type: none"> ■ Potable water treatment ■ Waste water treatment (industry and local authorities) ■ Sludge de-watering 	<ul style="list-style-type: none"> ■ For manual batching operation ■ Ultra-simple mixing system ■ PP storage tank

In-line preparation station

	Extraction rate l/h concentration max. 1.5 %	Application	Characteristic
ULIa <ul style="list-style-type: none"> ■ liquid 	55 – 2,000 (maturation period 15 min., starts with batching mode)	<ul style="list-style-type: none"> ■ Sludge dewatering and thickening ■ Potable water treatment ■ Waste water treatment (industry and local authorities) 	<ul style="list-style-type: none"> ■ integrated mixing and maturing chamber for fully activated liquid polymer solutions ■ Peristaltic pump and/or metering pumps for the metering of emulsions/dispersions ■ User-managed input of the concentration with proportional metering ■ optional specification of the polymer batching output

Pendulum system

	Extraction rate l/h concentration max. 0.5 %	Application	Characteristic
ULPa <ul style="list-style-type: none"> ■ powder ■ liquid 	400 – 4,000 (maturation period 60 min., starts with batching mode)	<ul style="list-style-type: none"> ■ Potable water treatment ■ Paper production 	<ul style="list-style-type: none"> ■ Simple screw feeder with good dosing precision proportional to the water supply ■ Functionally simple mixing system with wetting cone ■ Batching system using 2 PP storage tanks



2 Metering Systems

2.1.3 Questionnaire for the design of polymer batching and metering systems Ultromat® and PolyRex

For the treatment of

- Potable water
- Waste water
- Sludge
- Paper
- _____

Polymer available as

- Powdered polymer
- Liquid polymer
- Active substance: _____

Required quantities

- Concentration of the batched solution: _____
- Max. metering quantity (volume of polymer): _____
- Required maturing time: _____

Quality of dilution water

- Potable water
- Industrial water

Mains voltage supply

- 400 V AC/50/60 Hz
- 440 V AC/60 Hz
- 460 – 480 VAC/60 Hz
- Other: _____

Other requirements



2 Metering Systems

2.1.4

Preparation stations and metering of powdered and liquid polymer solutions Ultramat®

Preferred fields of application include:

- Potable water treatment
- Waste water treatment (industry and local authorities)
- Sludge de-watering
- Paper production

4 different system concepts are available:

- Continuous flow system (identity code ULFa)
- Oscillating system (identity code ULPa)
- Double-decker system (identity code ULDa)
- Inline batching station (identity code ULLa)

The systems differ primarily due to the construction of the storage tank. The storage tank in the continuous flow system is sub-divided into 3 chambers, largely preventing the mixing of fresh and matured polymer. The oscillating and double-decker systems consist of two completely separate storage tanks, preventing the mixing of fresh and matured polymer. An integrated mixing and maturing chamber is used with the inline batching station.

Powder feeder units and liquid concentrate pumps can be freely selected using the identity code. Powdered or liquid polymers can therefore be prepared depending on the application.

Ultramat® unit types ULFa, ULPa, ULDa and ULLa are equipped with a PLC compact controller and touch panel. Optionally the PLC compact controller can be fitted with a PROFIBUS®, Modbus or PROFINET module. Input of the solvent concentration, as well as calibration of the powder feeder unit and liquid concentrate pump is user-managed. Alarm messages and warnings are shown on the display. The feed of dilution water is continuously recorded by a flow meter and displayed on the touch panel. The control calculates the polymer requirement based on the set solvent concentration and proportionately controls the powder feeder unit or concentrate pump so that the concentration of polymer solution is always kept constant even if there are fluctuations in the water supply.

Application example for a ULFa polymer preparation system

- Powder feeder
- Redilution
- Chemical transfer pump
- Powder Storage Vessel
- Big Bag handling
- Ultramat® ULFa

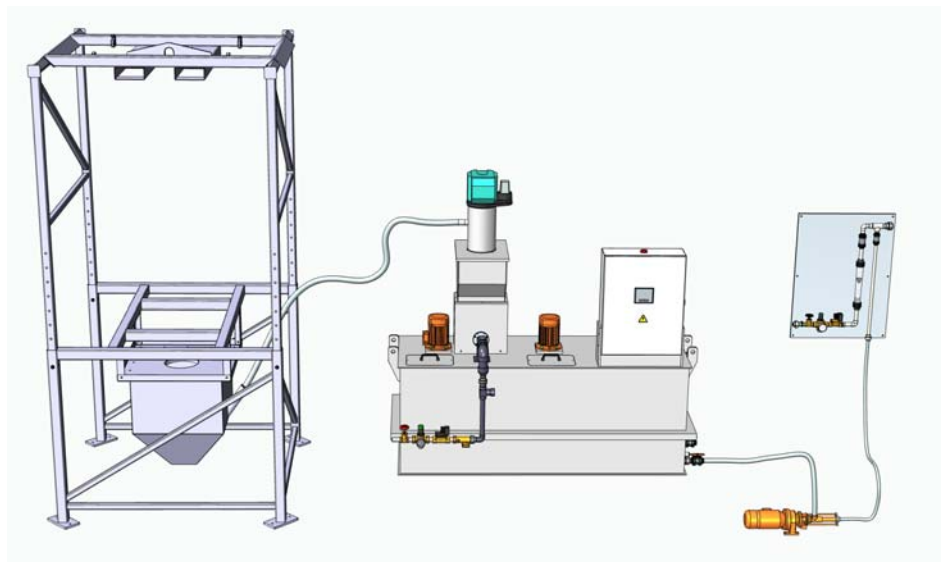

AP_0014_SW

2 Metering Systems

2.1.5 Metering System Ultromat® ULFa

Efficient production of a polymer solution with a high throughput capacity.

Extraction rates of up to 8,000 l/h



Polymer batching station Ultromat® ULFa (continuous flow system): This metering system can be used to batch flocculation aids for the preparation of a ready-to-use polymer solution. The system was designed for the fully automatic batching of polymer solutions.

These systems can be used to process both liquid and powdered polymers. The storage tank, which is subdivided into three chambers, largely prevents the carry-over of the freshly batched polymer.

Your benefits

- Processing of liquid polymers (0.05 – 1.0 %) and powdered polymers (0.05 – 0.5 %)
- Minimal carry-over of product and thus higher-quality results
- Extraction of the polymer solution and drainage of the chambers through the front of the storage tank
- User-managed input of the solvent concentration and calibration of powder feeder unit and liquid concentrate pump
- Gentle mixing of the polymer solution (electric stirrer)
- Pressure sensor for the measurement of the liquid level
- Version with terminal box available on request

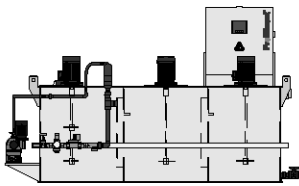

P_UL_0024_SW1

Ultromat® ULFa for liquid polymers

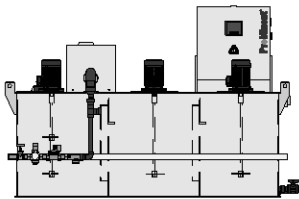

P_UL_0022_SW1

Ultromat® ULFa for powder polymers

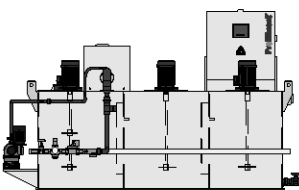

P_UL_0023_SW1

Ultromat® ULFa for powder and liquid polymers

Technical Details

Siemens S7 – 1200 compact control system and KTP 400 touch panel

- Optionally fitted with PROFIBUS® and DP/DP coupler
- Optionally fitted with Profinet and PN/PN coupler
- Optionally fitted with Modbus TCP

Field of application

- Potable water treatment
- Waste water treatment (industry and local authorities)
- Sludge de-watering

The following types of polymer can be processed:

- Liquid polymers (0.05 – 1.0 %)
- Powdered polymers (0.05 – 0.5%)

Selectable components:

- Tank size/ extraction rate
- Construction (normal or mirror image)
- Electrical connection
- Control S7 – 1200 (with and without PROFIBUS®/PROFINET/Modbus TCP)
- Powder feeder
- Vibrator for powder feeder (promotes the movement of polymer)
- Powder feeder unit FG205/ top hopper (for filling and feeding the powder feeder)
- Liquid concentrate pumps in the Sigma, Spectra, DULCO®flex ranges
- Monitor for liquid concentrate pump (float switch / flow monitor)
- Flush valve (Y-flush inlet or wetting cone)
- Stirrer for 3rd chamber
- Language (pre-set language for the control panel)

The standard scope of delivery includes among other things:

- Pause function/ operating message/ empty running function
- Monitoring of the re-dilution unit
- Lifting lugs for transport



2 Metering Systems

Technical Data

Discharge volume	l/h	400	1,000	2,000	4,000	6,000	8,000
Tank volume	l	400	1,000	2,000	4,000	6,000	8,000
Diluent water max.	l/h	600	1,500	3,000	6,000	9,000	12,000
Water pressure	bar	3 – 5	3 – 5	3 – 5	3 – 5	3 – 5	3 – 5
Powdered polymer	kg/h	0.5–11	0.5–11	0.8–18	3.6–55	3.6–55	4.8–110
Length	mm	1,999	2,643	3,292	3,301	4,120	4,605
Width	mm	918	1,002	1,186	1,456	1,651	1,910
Height	mm	1,390	1,740	1,890	2,182	2,182	2,290
Water connection	"	1	1	1	1 1/2	1 1/2	2
Discharge nozzle DN	mm	25	25	32	40	40	50
Concentrate feed DN	mm	15	15	15	20	20	20
Voltage / frequency	V/Hz	400/50	400/50	400/50	400/50	400/50	400/50
		460/60	460/60	460/60	460/60	460/60	460/60
Power uptake	kW	1.5	2.6	3.2	5.0	5.0	9.5

2 Metering Systems

Identity Code Ordering System for Continuous Flow Systems Ultramat® ULFa

ULFa	Type / Tank size / Discharge volume			
	0400	Continuous flow system / 400 l / 400 l/h	4000	Continuous flow system / 4000 l / 4000 l/h
	1000	Continuous flow system / 1000 l / 1000 l/h	6000	Continuous flow system / 6000 l / 6000 l/h
	2000	Continuous flow system / 2000 l / 2000 l/h	8000	Continuous flow system / 8000 l / 8000 l/h
Design				
	N	normal / propeller in PE/PVDF	S	mirror-inverted / propeller in PE/PVDF
	P	normal / propeller in stainless steel	Q	mirror-inverted / propeller in stainless steel
Electrical connection				
	A	380-420 VAC, 50 Hz (3-phase, N, PE)		
	B	440-480 VAC, 60 Hz (3-phase, N, PE)		
Control				
	0	PLC S7-1200	3	PLC Programmable Logic Controller S7 – 1200 with MODBUS TCP
	1	PLC S7-1200 with PROFIBUS® (DP/DP coupler)	4	with terminal box (without control cabinet)
	2	PLC Programmable Logic Controller S7-1200 with PROFINET (PN/PN coupler)		
Options				
	0	none		
	1	Discharge pipework, PVC (400, 1000)		
	2	Discharge pipework, PVC (2000)		
	3	Discharge pipework, PVC (4000, 6000)		
	4	Discharge pipework, PVC (8000)		
Powder feeder				
	P0	none		
	P1	Powder feeder (0400, 1000)		
	P2	Powder feeder (2000)		
	P3	Powder feeder (4000, 6000)		
	P4	Powder feeder (8000)		
Vibrator for powder feeder				
	0	none		
	1	with vibrator for powder feeder		
Powder conveyor FG 205, add-on hopper				
	0	none		
	1	with add-on hopper 50 l (0400, 1000, 2000)		
	2	with add-on hopper 75 l (4000, 6000)		
	3	with add-on hopper 100 l (8000)		
	4	with add-on hopper 50 l + powder conveyor unit FG205 (0400, 1000, 2000)		
	5	with add-on hopper 75 l + powder conveyor unit FG205 (4000, 6000)		
	6	with add-on hopper 100 l + powder conveyor unit FG205 (8000)		
	7	with adapter cover + powder conveyor unit FG205		
	A	with add-on hopper 50 l + visual level indicator (0400, 1000, 2000)		
	B	with add-on hopper 75 l + visual level indicator (4000/6000)		
	C	with add-on hopper 100 l + visual level indicator (8000)		
Liquid concentrate pump				
	L0	none		
	L1	with Sigma		
	L2	with Spectra		
	L3	prepared for Sigma		
	L4	prepared for Spectra		
	L5	prepared for Sigma, no bracket		
	L6	prepared for Spectra, no bracket		
	L7	prepared for peristaltic pump		
	L8	with peristaltic pump		
Monitoring for liquid concentrate pump				
	0	none		
	1	with float switch for concentrate tank		
	2	with flow monitor (only Spectra)		
	3	with float switch and flow monitor (only Spectra)		
Water pipework with wetting fitting				
	1	Y-wetting fitting, PVC (0400, 1000, 2000)		
	2	Y-wetting fitting, PVC (4000, 6000)		
	3	Y-wetting fitting, PVC (8000)		
	4	Wetting cone, PVC (0400, 1000, 2000)		
	5	Wetting cone, PVC (4000, 6000)		
	6	Wetting cone, PVC (8000)		
	7	Wetting cone, PP (0400, 1000, 2000)		
	8	Wetting cone, PP (4000, 6000)		
	9	Wetting cone, PP (8000)		
Stirrer for 3rd chamber				
	0	none		
	1	Stirrer for storage tank 400, 0.18/0.25 kW, 50/60 Hz		
	2	Stirrer for storage tank 1000, 0.55/0.68 kW, 50/60 Hz		
	3	Stirrer for storage tank 2000, 0.75/0.86 kW, 50/60 Hz		
	4	Stirrer for storage tank 4000/6000, 1.1/1.3 kW, 50/60 Hz		
	5	Stirrer for storage tank 8000, 2.2/2.55 kW, 50/60 Hz		
Language				
BG	Bulgarian			
CN	Chinese			
CZ	Czech			
DA	Danish			
DE	German			
EL	Greek			
EN	English			
ES	Spanish			
ET	Estonian			
FI	Finnish			
FR	French			
HR	Croatian			
HU	Hungarian			
IT	Italian			
LT	Lithuanian			
LV	Latvian			
MS	Malay			
NL	Dutch			
NO	Norwegian			
PL	Polish			
PT	Portuguese			
RO	Romanian			
RU	Russian			
SK	Slovakian			
SL	Slovenian			
SV	Swedish			
TR	Turkish			



2 Metering Systems

2.1.6 Metering System Ultramat® ULPa

A good solution when preparing polymer solutions as flocculation aids.

Extraction rates from 400 to 4,000 l/h

The metering system Ultramat® ULPa (pendulum system) is ideal for batching flocculation aids for the preparation of a ready-to-use polymer solution.

Ultramat® ULPa units consist of two separate chambers, which can be successively filled with polymer solution, eliminating the risk of product carry-over. Both liquid and powdered polymers can be processed depending on the product range.

Your benefits

- Processing of liquid polymers (0.05 - 1.0 %) and powdered polymers (0.05 - 0.5 %)
- No mixing of fresh and matured polymer
- Operator-controlled input of solvent concentration and calibration of powder feeder and liquid concentrate pump
- Gentle mixing of the polymer solution (electric stirrer)
- Pressure sensor for the measurement of the liquid level
- Version with terminal box available on request

Technical Details

Siemens S7 – 1200 compact control system and KTP 400 touch panel

- Optionally fitted with PROFIBUS® and DP/DP coupler
- Optionally fitted with PROFINET and PN/PN coupler
- Optionally fitted with Modbus TCP

Field of application

- Potable water treatment
- Paper production

The following types of polymer can be processed:

- Liquid polymers (0.05 – 1.0 %)
- Powdered polymers (0.05 – 0.5 %)

Selectable components:

- Tank size/extraction rate
- Construction (normal or mirror image)
- Electrical connection
- Control S7 – 1200 (with and without PROFIBUS®/PROFINET/Modbus TCP)
- Powder feeder
- Vibrator for powder feeder unit (promotes the movement of polymer)
- FG205 powder feeder/top hopper (for filling and feeding the powder feeder unit)
- Liquid concentrate pumps of types Sigma, Spectra, DULCO®flex
- Monitor for liquid concentrate pump (float switch / flow monitor)
- Flush valve
- Language (pre-set language for the control panel)

The standard scope of delivery includes among other things:

- Pause function/operating message/running dry function
- Monitoring of the re-dilution unit
- Lifting lugs for transport

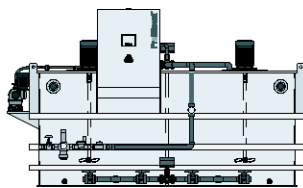

P_UL_0026_SW1
Ultramat® ULPa for liquid polymers

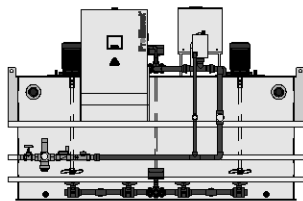

P_UL_0027_SW1
Ultramat® ULPa for powder polymers

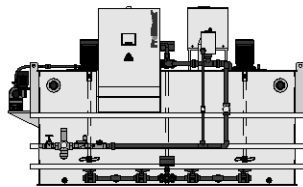

P_UL_0028_SW1
Ultramat® ULPa for powder and liquid polymers

2 Metering Systems

Technical Data

Discharge volume	l/h	400	1,000	2,000	4,000
Tank volume	l	2 x 400	2 x 1,000	2 x 2,000	2 x 4,000
Diluent water max.	l/h	1,600	4,000	8,000	14,000
Water pressure	bar	3 – 5	3 – 5	3 – 5	3 – 5
Powdered polymer	kg/h	0.5–11	0.8–18	3.6–55	4.8–110
Length	mm	2,040	2,840	3,340	4,540
Width	mm	1,253	1,733	1,918	2,583
Height	mm	1,635	1,739	2,178	2,384
Water connection	"	1	1 1/4	1 1/2	2
Discharge nozzle DN	mm	25	32	40	50
Concentrate feed DN	mm	15	15	20	20
Voltage/Frequency	VAC/Hz	400/50	400/50	400/50	400/50
Power uptake	kW	2.5	3.2	5.5	7.0



2 Metering Systems

Identity Code Ordering System for Oscillating Systems Ultramat® ULPa

ULPa	Type / Tank size / Discharge volume
	0400 Pendulum system / 2x400 l / 400 l/h
	1000 Pendulum system / 2x1,000 l / 1,000 l/h
	2000 Pendulum system / 2x2,000 l / 2,000 l/h
	4000 Pendulum system / 2x4,000 l / 4,000 l/h
Construction	
N	standard
S	mirror-imaged
Electrical connection	
A	400 VAC, 50/60 Hz (3ph, N, PE)
Control	
0	PLC S7-1200
1	PLC S7-1200 with PROFIBUS® (DP/DP coupler)
2	PLC Programmable Logic Controller S7-1200 with PROFINET (PN/PN coupler)
3	PLC Programmable Logic Controller S7 – 1200 with MODBUS TCP
Options	
0	none
Powder feeder	
P0	none
P1	Powder feeder (0400)
P2	Powder feeder (1000)
P3	Powder feeder (2000)
P4	Powder feeder (4000)
Vibrator for powder feeder	
0	none
1	with vibrator for powder feeder
Powder conveyor FG205, add-on hopper	
0	none
1	with add-on hopper 50 l (0400, 1000)
2	with add-on hopper 75 l (2000)
3	with add-on hopper 100 l (4000)
4	with add-on hopper 50 l + powder conveyor unit FG205 (0400, 1000)
5	with add-on hopper 75 l + powder conveyor unit (2000)
6	with add-on hopper 100 l + powder conveyor unit (4000)
7	with adapter cover + powder conveyor unit
Liquid concentrate pump	
L0	none
L1	with Sigma
L2	with Spectra
L3	prepared for Sigma
L4	prepared for Spectra
L5	prepared for Sigma, no bracket
L6	prepared for Spectra, no bracket
L7	prepared for peristaltic pump
L8	with peristaltic pump
Monitor for liquid concentrate pump	
0	none
1	with float switch for concentrate tank
2	with flow monitor (only Spectra)
3	with float switch and flow monitor (only Spectra)
Water pipework with wetting fitting	
0	without wetting cone (liquid version)
1	Wetting cone, PVC (0400)
2	Wetting cone, PVC (1000, 2000)
3	Wetting cone, PVC (4000)
4	Wetting cone, PP (0400)
5	Wetting cone, PP (1000, 2000)
6	Wetting cone, PP (4000)
Language	
BG	Bulgarian
CN	Chinese
CZ	Czech
DA	Danish
DE	German
EL	Greek
EN	English
ES	Spanish
ET	Estonian
FI	Finnish
FR	French
HR	Croatian
HU	Hungarian
IT	Italian
LT	Lithuanian
LV	Latvian
MS	Malay
NL	Dutch
NO	Norwegian
PL	Polish
PT	Portuguese
RO	Romanian
RU	Russian
SK	Slovakian
SL	Slovenian
SV	Swedish
TR	Turkish



2 Metering Systems

2.1.7

Metering System Ultramat® ULDa

A good solution when preparing polymer solutions as flocculation aids.

Extraction rates of up to 2,000 l/h

The ProMinent metering system Ultramat® ULDa is an automatic polyelectrolyte preparation system. It is useful wherever polymers need to be automatically prepared as polymer solutions to act as flocculation aids.



Ultramat® ULDa double-decker systems are used to process liquid and powdered polymers. The system consists of two separate PP storage tanks, stacked above each other, preventing product carry-over. The polymer solution is batched in the upper storage tank and can be transferred to the lower storage tank once the maturing time has elapsed.

Your benefits

- Processing of liquid polymer (0.05 – 1.0 %) and powdered polymers (0.05 – 0.5 %)
- No mixing of fresh and matured polymer
- Wide range of versions for specific applications
- Operator-controlled input of solvent concentration and calibration of powder feeder and liquid concentrate pump
- Water apparatus with flow meter and fitting set for the dilution water
- Gentle mixing of the polymer solution (electric stirrer)
- Pressure sensor for the measurement of the liquid level
- Version with terminal box available on request

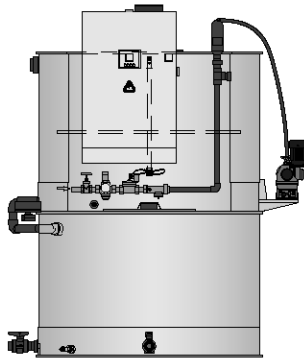

P_UL_0029_SW1
Ultramat® ULDa for liquid polymers

Technical Details

Siemens S7 – 1200 compact control system and KTP 400 touch panel

- PLC Programmable Logic Controller optionally fitted with PROFIBUS® and DP/DP coupler
- Optionally fitted with Profinet and PN/PN coupler
- Optionally fitted with Modbus TCP

Field of application

- Potable water treatment
- Waste water treatment (industry and local authorities)
- Sludge de-watering
- Paper production

The following types of polymer can be processed:

- Liquid polymers (0.05 – 1.0 %)
- Powdered polymers (0.05 – 0.5 %)

Selectable components:

- Tank size/extraction rate
- Construction (normal or mirror image)
- Electrical connection
- Control S7 – 1200 (with and without PROFIBUS®/PROFINET/Modbus TCP)
- Powder feeder
- Vibrator for powder feeder unit (promotes the movement of polymer)
- FG205 powder feeder/top hopper (for filling and feeding the powder feeder unit)
- Liquid concentrate pumps of types Sigma, Spectra, DULCOflex
- Monitor for liquid concentrate pump (float switch / flow monitor)
- Flush valve (Y-flush inlet or wetting cone)
- Language (pre-set language for the control panel)

The standard scope of delivery includes among other things:

- Pause function/operating message/running dry function
- Monitoring of the re-dilution unit
- Lifting lugs

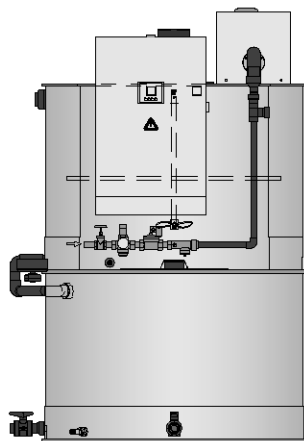

P_UL_0030_SW1
Ultramat® ULDa for powder polymers

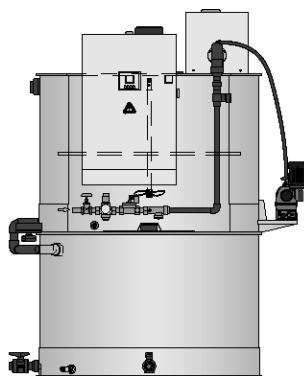

P_UL_0031_SW1
Ultramat® ULDa for powder and liquid polymers



2 Metering Systems

Technical Data

Discharge volume	l/h	400	1,000	2,000
Tank volume	l	2 x 400	2 x 1,000	2 x 2,000
Diluent water max.	l/h	1,600	4,000	8,000
Water pressure	bar	3 – 5	3 – 5	3 – 5
Powdered polymer	kg/h	0.5–11	0.8–18	3.6–55
Length	mm	1,638	1,902	2,288
Width	mm	1,351	1,615	2,005
Height	mm	2,030	2,514	3,149
Water connection	"	1	1	1 1/2
Discharge nozzle DN	mm	25	32	40
Concentrate feed DN	mm	15	15	20
Voltage/Frequency	VAC/Hz	400/50	400/50	400/50
Power uptake	kW	1.5	2.6	3.2



2 Metering Systems

Identity Code Ordering System for Double-deck System Ultramat® ULDa

ULDa	Type / Tank size / Discharge volume		
	0400 Double-deck system / 2x400 l / 400 l/h		
	1000 Double-deck system / 2x1,000 l / 1,000 l/h		
	2000 Double-deck system / 2x2,000 l / 2,000 l/h		
Construction			
N	standard		
S	mirror-imaged		
Electrical connection			
A	400 VAC, 50/60 Hz (3ph, N, PE)		
Control			
0	PLC S7-1200		
1	PLC S7-1200 with PROFIBUS® (DP/DP coupler)		
2	PLC Programmable Logic Controller S7-1200 with PROFINET (PN/PN coupler)		
3	PLC Programmable Logic Controller S7 – 1200 with MODBUS TCP		
Options			
0	none		
Powder feeder			
P0	none		
P1	Powder feeder (0400)		
P2	Powder feeder (1000)		
P3	Powder feeder (2000)		
Vibrator for powder feeder			
0	none		
1	with vibrator for powder feeder		
Powder conveyor FG205, add-on hopper			
0	none		
1	with add-on hopper 50 l		
2	with add-on hopper 75 l		
3	with add-on hopper 100 l		
4	with add-on hopper 50 l + powder conveyor unit		
5	with add-on hopper 75 l + powder conveyor unit		
6	with add-on hopper 100 l + powder conveyor unit		
7	with adapter cover + powder conveyor unit		
Liquid concentrate pump			
L0	none		
L1	with Sigma		
L2	with Spectra		
L3	prepared for Sigma		
L4	prepared for Spectra		
L5	prepared for Sigma, no bracket		
L6	prepared for Spectra, no bracket		
L7	prepared for peristaltic pump		
L8	with peristaltic pump		
Monitor for liquid concentrate pump			
0	none		
1	with float switch for concentrate tank		
2	with flow monitor (only Spectra)		
3	with float switch and flow monitor (only Spectra)		
Water pipework with wetting fitting			
1	Y-wetting fitting, PVC (0400)		
2	Y-wetting fitting, PVC (1000)		
3	Y-wetting fitting, PVC (2000)		
4	Wetting cone, PVC (0400)		
5	Wetting cone, PVC (1000)		
6	Wetting cone, PVC (2000)		
7	Wetting cone, PP (0400)		
8	Wetting cone, PP (1000)		
9	Wetting cone, PP (2000)		
Language			
BG	Bulgarian	LT	Lithuanian
CN	Chinese	LV	Latvian
CZ	Czech	MS	Malay
DA	Danish	NL	Dutch
DE	German	NO	Norwegian
EL	Greek	PL	Polish
EN	English	PT	Portuguese
ES	Spanish	RO	Romanian
ET	Estonian	RU	Russian
FI	Finnish	SK	Slovakian
FR	French	SL	Slovenian
HR	Croatian	SV	Swedish
HU	Hungarian	TR	Turkish
IT	Italian		



2 Metering Systems

2.1.8

Metering system Ultramat® UL1a (inline system liquid)

Metering system specifically designed for the batching of a fully activated liquid polymer solution

Extraction volume 50 – 2,000 l/h against 3-6 bar



The polymer batching system Ultramat® UL1a is an inline system and processes liquid polymers to produce a fully activated solution. It is ideally equipped for your application with integrated mixing and maturing chamber and novel peristaltic metering pump.

The metering system Ultramat® UL1a is a compact inline batching station. It features a special mixing chamber in which liquid polymer is added by peristaltic or metering pumps. Optimum mixing with water produces a matured and fully activated polymer solution. An additional maturing tank with stirrer and feed pump can be installed downstream to create a batch preparation station.

The concentration of the polymer solution can be simply adjusted on the touch panel.

Optionally continuous polymer batch output in l/h can be specified. The polymer batching system works reliably and conserves resources, thanks to its optimum process control.

Your benefits

- precise processing of liquid polymers (0.05 – 1.5%)
- highly efficient mixing chamber for emulsions / dispersions and water
- user-managed input of the concentration with proportional metering
- compact design with various installation options
- optional operator-managed specification of the polymer batching output in l/h

Technical Details

- Proportional metering as standard
- 3 system types with different equipment can be selected:
 - basic - manual flow adjustment, manual flushing
 - medium - automatic flow control, manual flushing
 - comfort - automatic flow control, automatic flushing
- Integrated post dilution unit optionally available

Choice of peristaltic or metering pumps:

- Peristaltic pump DFXa 0530 for back pressures of up to 3 bar, max. 5 bar
- Metering pumps gamma/ X with HV head
- Metering pumps Sigma

Compact controller Schneider Electric TM241 and touch panel STO735 4.3"

- Optionally fitted with Ethernet / Modbus TCP
- Optionally fitted with PROFIBUS®

Field of application

- Sludge dewatering and sludge thickening
- Waste water treatment (industry and local authorities)
- Potable water treatment

The following types of polymer can be processed:

- Liquid polymers (0.05 – 1.5 %)
- as emulsions or dispersions

Selectable components:

- Batching output as an inline batching station or batch preparation station
- Configuration versions
- Electrical connection
- Control versions with or without data communication
- Operating versions
- Liquid polymer metering pumps
 - Peristaltic pump DFXa
 - Metering pump gamma/ X
 - Metering pump Sigma 1 Control
- Monitoring of low liquid polymers
- Raw water booster pump
- Post-dilution unit
- additional maturing tank with stirrer for batch preparation
- Feed pump for additional maturing storage tank
- Language

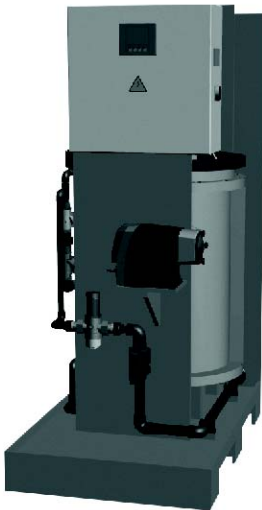

P_UL_0043_SW1

NEW



2 Metering Systems

Technical Data

Ultramat ULIIa system type		100	200	400	1000	2000
Extraction rate max. / inline with concentrations of 0.05 – 1.5%	l/h	100	200	400		
Extraction rate max. / inline with post dilution	l/h	1000	2000	4000		
Extraction rate max. as batch preparation station with concentrations up to 1.5%	l/h	100	200	1000	1000	2000
Max. water pressure of raw water	bar	8	8	8	8	8
Liquid polymer dosing capacity	l/h	4	8	30	40	80
Length	mm	1,200	1,200	1,200		
Width	mm	800	800	800		
Height	mm	1,700	1,700	1,700		
Water connection DN		25	25	25	25	
Discharge nozzle DN		25	25	25	25	
Protection class		IP 55	IP 55	IP 55	IP 55	IP 55
Voltage / frequency	V/Hz	220-240/ 50-60	220-240/ 50-60	220-240/ 50-60	220-240/ 50-60	220-240/ 50-60
Power uptake	kW					
Back-up fuse	A					



2 Metering Systems

Identity code ordering system for Ultramat® ULLa inline systems liquid

ULLa	Type
100	Inline batching station 50 - 100 l/h
200	Inline batching station 94 - 200 l/h
400	Inline batching station 188 - 400 l/h
1000	Batch preparation station 1,000 l/h with maturing tank
2000	Batch preparation station 2,000 l/h with maturing tank
Construction	
NP	Standard / wall-mounted
NV	Standard / vertical to the wall
SP	mirror-inverted / wall-mounted
SV	mirror-inverted / vertical to the wall
Electrical connection	
EU	220-240 VAC 50 Hz
US	100-120 VAC 60 Hz
Control and data communication	
0	with PLC Schneider PLC TM241 series
1	with SPS Schneider PLC TM241 series + Ethernet switch box / Modbus
2	with PLC Schneider PLC TM241 series + Profibus
Operating version	
B	basic - manual flow adjustment, proportional metering, manual flushing
M	medium - automatic flow control, proportional metering, manual flushing
C	comfort - automatic flow control, proportional metering, automatic flushing
Metering pump for liquid polymer	
L1	Peristaltic pump DFXa 0530 for ULLa 100, 200, 400 (up to 3 (5) bar back pressure)
L2	Metering pump gamma/ X HV for ULLa 100, 200 (up to 6 bar back pressure)
L3	Metering pump Sigma for ULLa 400, 1000 and 2000 (up to 6 bar back pressure)
Liquid polymer tank liquid level monitor	
0	none
1	capacitive sensor
Raw water booster pump	
B0	none
BP	prepared / with control signal
B1	installed
Post-dilution unit	
D0	none
D1	installed
additional maturing/storage tank with equipment	
A0	none
AP	prepared
A1	100 l for ULLa 100/200
A2	250 l for ULLa 100/200/400
A3	500 l for ULLa 100/200/400
A4	1,000 l for ULLa 100/200/400
Stirrer for maturing/storage tank	
0	none
1	installed
Feed pump for maturing/storage tank	
F0	none
FP	prepared / with control signal
F1	Spectra type 1 frequency converter-controlled in accordance with the system's performance
F2	Spectra type 2 frequency converter-controlled with higher performance
Language	
CZ	Czech
DE	German
EN	English
ES	Spanish
FI	Finnish
FR	French
IT	Italian
PT	Portuguese
SV	Swedish
ZH	Chinese



2 Metering Systems

2.1.9 Metering System Ultromat® MT for Batch Operation

This manual polymer batching station is worthwhile if you only work with small quantities.

Capacity range 120 – 3,800 l/h

Manual polymer batching station Ultromat® MT: Perfect metering system for the processing of small quantities of liquid and powdered polymers: extremely robust and cost-effective.



The Ultromat® MT is ideal for individually batching polymer solutions where there is no need for automatic operation. The powdered polymer is added manually through the wetting cone to the maturing tank and mixed by the stirrer. After the maturing time, the flocculant solution can then be metered into the application.

Your benefits

- Ideal for use where there is no need for continuous operation
- Manual addition of flocculants
- Robust and cost-effective
- Round polypropylene batching tank
- Flushing system with wetting cone and injector
- Gentle mixing of the polymer solution

Technical Details

- Slowly-running stirrer
- Flushing system
- Level switch (Low flow, Min, Max contact)
- Terminal box

Field of application

- Potable water treatment
- Waste water treatment (industry and local authorities)
- Sludge de-watering

The systems consist of:

- 1 PP batching tank
- 1 Flushing system for flushing and wetting the powder with wetting cone, injector and fitting set for the dilution water
- 1 Slow-running electric stirrer
- 1 Level switch with three switching points
- 1 Terminal box

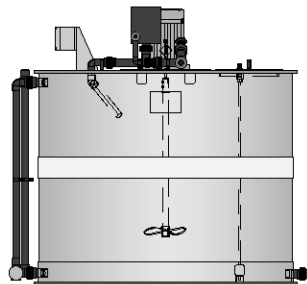

P_UL_0025_SW1

Ultromat® MT

	Order no.
MT 140, stirrer 0.18 kW	1037073
MT 250, stirrer 0.55 kW	1037094
MT 500, stirrer 0.75 kW	1037095
MT 1000, stirrer 1.1 kW	1037096
MT 2000, stirrer 2.2 kW	1037097
MT 3000, stirrer 2.2 kW	1037098
MT 4000, stirrer 3 kW	1037099

Technical Data

Type		MT 140	MT 250	MT 500	MT 1000	MT 2000	MT 3000	MT 4000
Discharge volume	l/h	120	210	440	920	1,890	2,850	3,800
Tank volume	l	120	210	440	920	1,890	2,850	3,800
Diameter of tank	mm	640	650	850	1,260	1,460	1,770	1,650
Height of tank	mm	714	1,116	1,018	1,016	1,518	1,620	2,072
Height	mm	1,003	1,405	1,309	1,320	1,875	1,998	2,496
Water connection DN	mm	20	20	20	25	32	40	40
Discharge nozzle DN	mm	20	20	20	25	32	40	40
Voltage/Frequency	VAC/Hz	400/50	400/50	400/50	400/50	400/50	400/50	400/50
Power uptake	kW	0.18	0.55	0.75	1.10	2.20	2.20	3.00

The systems are also available with flushing water fitting, level indicator and switchgear.



2 Metering Systems

2.1.10

Ultromat® Accessories including Big Bag Systems

Ultromat® VS dilution unit

The Ultromat® post dilution units are fully assembled units for the post-dilution of polymer solutions, essentially consisting of:

- 1 Water apparatus for the dilution water with manual shut-off valve, pressure reducer, 24 V DC solenoid valve and float flow meter including minimum contact
- 1 Pipework for the polymer solution to be diluted including non-return valve
- 1 Static mixer integrated into the output pipework for mixing the stock solution with the dilution water

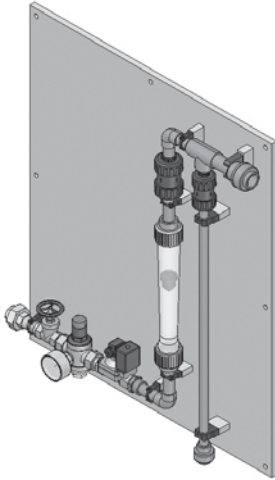

P_AC_0287_SW1

	Process solution	Order no.
VS 1000	1,000 l/h	1096130
VS 2000	2,000 l/h	1096131
VS 5000	5,000 l/h	1096132
VS 10000	10,000 l/h	1096133
VS 20000	20,000 l/h	1096134
VS 30000	30,000 l/h	1096135
VS 50000	50,000 l/h	1096136

Ultromat® VS-IP dilution unit with flow meter

The Ultromat® post dilution units are fully assembled units for the pot-dilution of polymer solutions, essentially consisting of:

- 1 Water apparatus for the dilution water with manual shut-off valve, pressure reducer, 24 V DC solenoid valve and float flow meter including minimum contact
- 1 Pipework for the polymer solution to be diluted including non-return valve and inductive flow meter
- 1 Static mixer integrated into the output pipework for mixing the stock solution with the dilution water

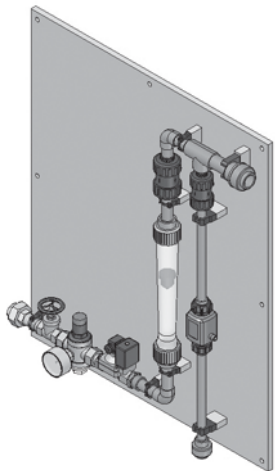

P_AC_0288_SW1

	Process solution	Order no.
VS 1000 IP	1,000 l/h	1096137
VS 2000 IP	2,000 l/h	1096138
VS 5000 IP	5,000 l/h	1096139
VS 10000 IP	10,000 l/h	1096140
VS 20000 IP	20,000 l/h	1096142
VS 30000 IP	30,000 l/h	1096143
VS 50000 IP	50,000 l/h	1096144

Ultromat® powder conveyor FG 205

The Ultromat® powder feeder FG 205 is used to top up the dry feeder of the Ultromat® systems with commercially available powdered polymers. A suction hose and a suction lance are used to draw the powder from the storage container (Big Bag, powder storage tank) into the powder feeder and to transport it through a flap into the dry feeder of the polymer dissolving station. The powder feeder is self-controlled and simply needs a 230 V single-phase connection. External switch contacts are not needed. Approx. 40 kg powdered polymer can be transported per hour depending on the properties of the powder. The 4-metre long transport hose and extraction nozzle are included in the scope of delivery.

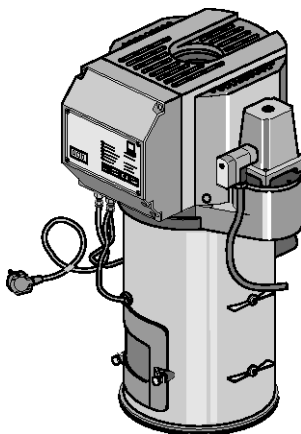

pk_3_032

	Feed rate	Order no.
Powder conveyor FG 205 230 VAC/50 Hz	40 kg/h	1000664
Powder conveyor FG 205 230 VAC/60 Hz	40 kg/h	1061422



2 Metering Systems

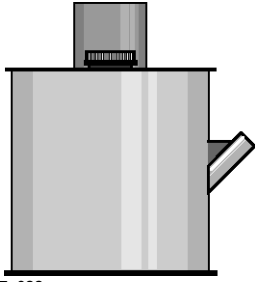

pk_7_033

Powder pre-storage tank

The powder pre-storage tank is used for interim storage of powdered polymers that are delivered in Big-Bags. The Big-Bag is suspended over the tank on a frame and emptied into the powder pre-storage tank.

Powder pre-storage tank	Order no. 1005573
--------------------------------	-----------------------------

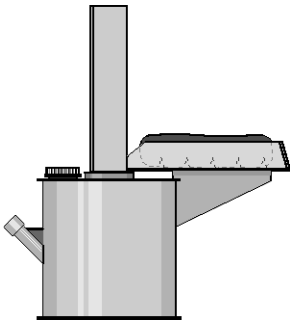

pk_7_060

Powder pre-storage tank with bag tipper

The powder pre-storage tank with bag tipper is used for interim storage of powdered polymers delivered in 25 kg sacks.

Powder pre-storage tank with bag tipper	Order no. 1025137
--	-----------------------------



2 Metering Systems

Big-Bag emptying units

These emptying units are used to hold and empty Big Bags weighing up to 1,000 kg. A powder hopper is used to transfer the powder into a special feed unit, such as powder feeder FG 205, thereby ensuring the supply of powder to the dry feeder of the polymer preparation station.

Big Bag emptying unit, standard

- Height-adjustable frame
- Standard design in painted steel
- Integrated suspension cross for the Big Bags
- Suitable for loading with crane or fork-lift
- Powder storage tank with approx. 200-litre content
- Powder re-filling probe

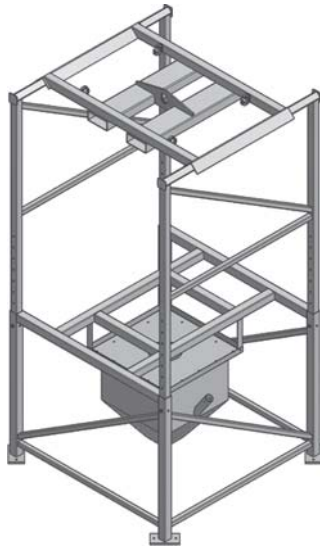

P_UL_0036_SW

Order no.

Big Bag emptying unit, standard

1083075

Big Bag emptying unit with electrical lifting equipment

- Standard design in painted steel
- Integrated travelling crane
- Electrical lifting equipment with suspension cross for the Big Bags
- Powder storage tank with approx. 200-litre content
- Powder re-filling probe



P_UL_0035_SW

Order no.

Big Bag emptying unit with electrical lifting equipment

1083076

Big Bag emptying unit with dust-free emptying option

- Additional unit under the Big Bag including dust filter

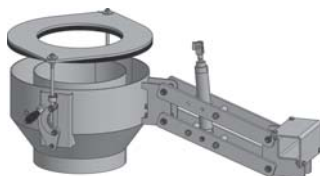

P_UL_0037_SW

Order no.

Big Bag emptying unit with dust-free emptying option

1083077

2 Metering Systems

2.1.11

Batching stations and metering of powdered and liquid polymer solutions PolyRex

Preferred fields of application include:

- Potable water treatment
- Waste water treatment (industry and local authorities)
- Sludge de-watering
- Paper production

3 different automatic system concepts are available:

- Treatment system with vacuum conveyor (PolyRex)
- Treatment system with Big Bag emptying system (PolyRex Big Bag)
- Treatment system for commercially-available liquid polymer (PolyRex Liquid)

PolyRex is a turnkey system for treatment in batch quantities of powder and liquid polymers. All PolyRex systems rely on 2 stainless steel tanks; a batch maturing tank and a storage tank in a double-deck arrangement or in parallel.

PolyRex uses a highly effective, three-stage process for wetting, water acceleration and gentle but efficient mixing in the mixing tank, in order to produce a homogeneous, activated polymer solution.

The batch treatment system offers significant advantages over a continuous system. How?: The short circuit effect is avoided. The polymer particles cannot pass through the process without being activated.

The tried and tested multi-screw feeder ensures reliable drainage without pulsation along with precise metering. This ensures that batches are compiled precisely. When commercially-available liquid polymers are used, a reliable progressive cavity pump is used, ensuring safe and highly accurate metering.

PolyRex systems are fitted with a PLC compact controller and touchpanel. Optionally, the PLC compact controller can be fitted with PROFIBUS® or Ethernet module. Commissioning is made easy. Input of the solvent concentration, as well as calibration of the powder feeder and liquid concentrate pump is user-managed. Alarm messages and warnings are shown on the display.

Application example for a PolyRex polymer preparation system

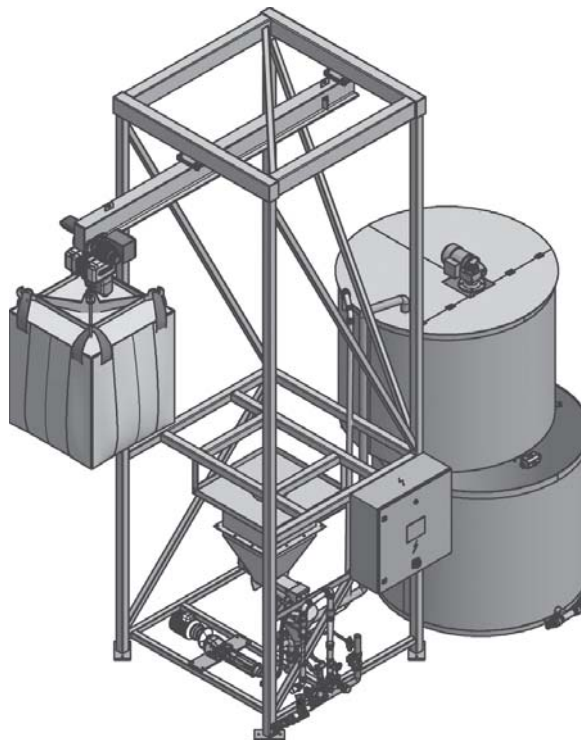

P_UL_0040_SW



2 Metering Systems

2.1.12 Metering System PolyRex

PolyRex can do more: Processes liquid and powdered polymers.

Capacity range of up to 8200 l/h



The metering system PolyRex is a double-decker batching station for the processing of liquid and powdered polymers. It consists of the feed and mixer unit and the two stainless steel double-decker tanks. The polymers used are ideally utilised.

The upper storage tank represents the batching/ maturing tank. The lower tank is the storage tank for the prepared polymer solution. The powdered polymer is transported to the powder feeder by a vacuum conveyor using 2 conveyor screws and mixed into 3 layers with water in the underlying mixer unit; wetting cone, water injector and stirrer in batching tank. The solution is then transferred to the upper storage tank using the water pressure of the diluting water. The polymer solution matures completely in this, a short circuit effect is avoided. After maturing, the solution can be transferred to the lower storage tank via the motorised valve.

Your benefits

Compact controller ABB AC500 PM573-ETH and touch panel CP635

- Dust-free filling of the powder storage tank thanks to use of a vacuum conveyor
- Double screw metering unit with 2 counter-rotating conveyor screws enables low-pulsation metering with a high level of dosing precision.
- Pressure reducer provides for a constant water supply
- Effective 3-phase mixing of the polymer solution
- No short-circuiting effect: polymer particles cannot pass through the process without activation

Technical Details

- Vacuum conveyor for filling from small powder bags
- Powder top hopper with inspection glass
- Powder level probe for detecting an empty top hopper
- Shut-off damper on feeder to prevent moisture infiltration
- Wetting cone in stainless steel for dissolving of the powder
- Water apparatus with wetting cone and injector to produce an effective and homogeneous polymer solution from powdered polymers
- Stainless steel tank for maturing and feeding the polymer solution in slightly offset double-deck arrangement for PolyRex 0.6 - 8.4, with adjacent tanks for PolyRex Maxi 11 - 23
- Motorised valve to dispense the solution into the storage tank
- Slow-running stirrer in the upper storage tank for gentle mixing of the polymer solution

Field of application

- Potable water treatment
- Waste water treatment (industry and local authorities)
- Sludge de-watering
- Paper production

Options

- Batching commercially-available liquid polymers using a progressive cavity pump
- Heating elements at wetting cone entrance and at feeder output (recommended for environment with high air humidity)
- PROFIBUS® or Ethernet communication
- Compact controllers from Siemens or Allen Bradley on request
- Water apparatus and piping in stainless steel design

Accessories

- Re-dilution with highly effective static mixer
- Progressive cavity pump with speed control
- Electromagnetic flow meter for precise control of the metering pump

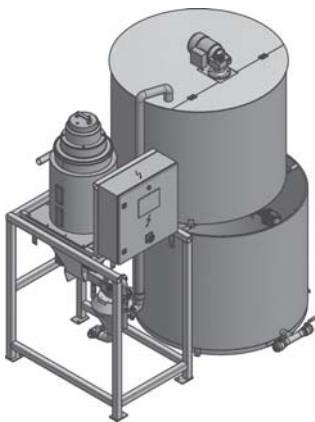

P_UL_0041_SW

2 Metering Systems

Technical Data

	Tank volume m ³	Discharge volume l/h	Polymer dosing capacity kg/h
PolyRex 0.6	2 x 0.3	240	1.2
PolyRex 1.0	2 x 0.6	460	2.3
PolyRex 2.0	2 x 1.0	940	4.7
PolyRex 3.0	2 x 1.5	1,280	6.4
PolyRex 4.0	2 x 2.0	1,900	9.5
PolyRex 5.4	2 x 2.7	2,400	12.0
PolyRex 6.6	2 x 3.3	3,200	16.0
PolyRex 8.4	2 x 4.2	3,820	19.2
PolyRex Maxi 11	2 x 5.5	5,100	25.5
PolyRex Maxi 16	2 x 8.0	6,600	33.0
PolyRex Maxi 23	2 x 11.5	8,200	41.0



2 Metering Systems

2.1.13 Metering System PolyRex Big Bag

The PolyRex can do more: it processes liquid and powdered polymers.

Capacity range of up to 8200 l/h



The metering system PolyRex is a double-decker batching station for the processing of liquid and powdered polymers. It consists of the feed and mixer unit and the two stainless steel double-decker tanks. The polymers used are ideally utilised.

The upper storage tank represents the batching/ maturing tank. The lower tank is the storage tank for the prepared polymer solution.

The powdered polymer is transported to the powder feeder by a vacuum conveyor using 2 conveyor screws and mixed into 3 layers with water in the underlying mixer unit; wetting cone, water injector and stirrer in batching tank. The solution is then transferred to the upper storage tank using the water pressure of the diluting water. The polymer solution matures completely in this, a short circuit effect is avoided. After maturing, the solution can be transferred to the lower storage tank via the motorised valve.

Your benefits

Compact controller ABB AC500 PM573-ETH and Touchpanel CP635

- Flexible and height-adjustable Big Bag emptying system with integrated spider clamp for loading with crane or forklift
- Double-screw feeder with 2 reverse conveyor screws enables low-pulsation metering with a high level of dosing precision
- Pressure reducer provides for a constant water supply
- Effective 3-phase mixing of polymer solution
- No short circuit effect, polymer particles cannot pass through the process without being activated

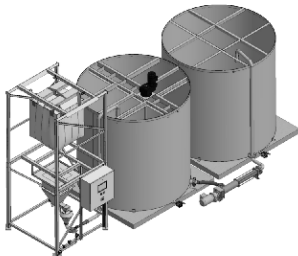

P_UL_0039_SW

Technical Details

- Powder top hopper with inspection glass
- Powder level probe for detecting an empty top hopper
- Shut-off damper on feeder to prevent moisture infiltration
- Wetting cone in stainless steel for dissolving of the powder
- Water apparatus with wetting cone and injector to produce an effective and homogeneous polymer solution from powdered polymers
- Stainless steel tank for maturing and feeding the polymer solution in slightly offset double-deck arrangement for PolyRex 0.6 - 8.4, with adjacent tanks for PolyRex Maxi 11 - 23
- Motorised valve to dispense the solution into the storage tank
- Slow-running stirrer in the upper storage tank for gentle mixing of the polymer solution

Field of application

- Potable water treatment
- Waste water treatment (industry and local authorities)
- Sludge de-watering
- Paper production

Options

- Big Bag emptying unit with travelling crane and electrical lifting equipment
- Dust-free emptying, thanks to additional unit under the Big Bag including dust filter
- Batching of commercially available liquid polymers by the use of an eccentric screw pump
- Heating element at the inlet of the wetting cone and/or at the outlet of the metering unit (recommended for environments with high air humidity)
- PROFIBUS® or Ethernet communication
- Compact Siemens or Allen Bradley controller on request
- Water apparatus and piping in stainless steel design

Accessories

- Re-dilution with highly effective static mixer
- Eccentric screw pump with speed control
- Electromagnetic flow meter for the precise control of the metering pump

2 Metering Systems

Technical Data

	Tank volume m ³	Discharge volume l/h	Polymer dosing capacity kg/h
PolyRex 0.6	2 x 0.3	240	1.2
PolyRex 1.0	2 x 0.6	460	2.3
PolyRex 2.0	2 x 1.0	940	4.7
PolyRex 3.0	2 x 1.5	1,280	6.4
PolyRex 4.0	2 x 2.0	1,900	9.5
PolyRex 5.4	2 x 2.7	2,400	12.0
PolyRex 6.6	2 x 3.3	3,200	16.0
PolyRex 8.4	2 x 4.2	3,820	19.2
PolyRex Maxi 11	2 x 5.5	5,100	25.5
PolyRex Maxi 16	2 x 8.0	6,600	33.0
PolyRex Maxi 23	2 x 11.5	8,200	41.0



2 Metering Systems

2.1.14 Metering System PolyRex Liquid

The PolyRex can do more: it processes common liquid polymers.

Capacity range of up to 3180 l/h



The metering system PolyRex is a double-decker batching station for the processing of liquid polymers. It consists of the feed and mixer unit and the two stainless steel double-decker tanks. The polymers used are ideally utilised.

The upper storage tank represents the batching/maturing tank. The lower tank is the storage tank for the prepared polymer solution.

The liquid polymer is fed in by an eccentric screw pump and an injection nozzle and mixed with water in 2 stages by means of a water injector and a stirrer in the batching/maturing tank. The solution is transferred to the upper storage tank using the water pressure of the diluting water. The polymer solution can fully mature in this, avoiding a short-circuiting effect. After maturing, the solution can be transferred to the bottom storage tank via the motorised valve.

Your benefits

Compact controller ABB AC500 PM573-ETH and touch panel CP635

- Reliable eccentric screw pump for the metering of commercially available polymers
- High energy mixing process
- Unique injection nozzle prevents clogging of the liquid polymer
- Pressure reducer provides for a constant water supply
- Effective 2-phase mixing of the polymer solution
- No short-circuiting effect: polymer particles cannot pass through the process without activation

Technical Details

- Water apparatus with wetting cone and injector to produce an effective and homogeneous polymer solution
- Double-decker storage tank made of stainless steel for maturing and storing the polymer solution
- Motorised valve to dispense the solution into the storage tank
- Slow-rotating stirrer in the upper storage tank for the gentle mixing of the polymer solution

Field of application

- Waste water treatment (industry and local authorities)
- Sludge de-watering

Options

- PROFIBUS® or Ethernet communication
- Compact controllers from Siemens or Allen Bradley on request
- Water apparatus and piping in stainless steel design

Accessories

- Re-dilution with highly effective static mixer
- Eccentric screw pump with speed control
- Electromagnetic flow meter for precise control of the metering pump

Technical Data

	Tank volume m ³	Discharge volume l/h	Polymer dosing capacity kg/h
PolyRex Liquid 1.0	2 x 0.5	1,060	5.3
PolyRex Liquid 2.0	2 x 1.0	1,900	9.5
PolyRex Liquid 3.0	2 x 1.5	2,480	12.4
PolyRex Liquid 4.0	2 x 2.0	3,180	15.9

Note:The capacity of liquid polymer in kg/h denotes a 100 % active ingredient content. Naturally, the concentration of the active ingredient in the systems can be adjusted to the commercially available liquid polymers with a 30 - 60 % active ingredient percentage.

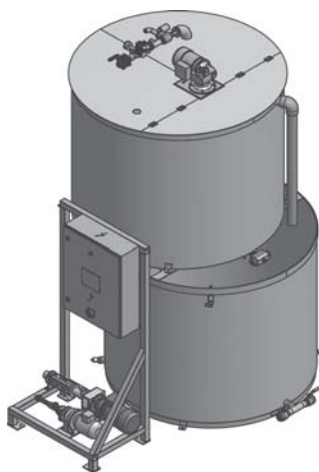



P_UL_0038_SW

2 Metering Systems

2.1.15 PolyRex Accessories – Mixing Systems

The PolyRex and PolyRex Big Bag systems are fitted with special mixing systems for powdered polymer.

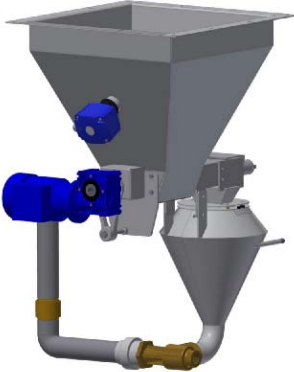
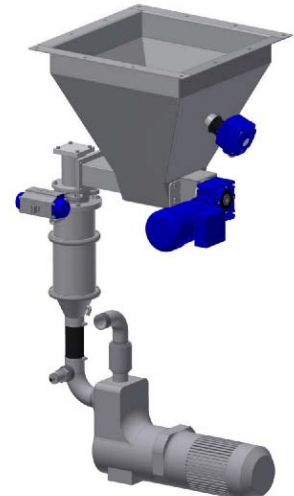
Efficient mixing systems for polymers

	<p>PolyRex Classic</p>	<p>Use Standard</p>	<p>Polymer ■ Powder ■ Liquid</p>	<p>Mixing unit Cyclonic wetting cone</p>	<p>Application / benefits ■ Reliable and effective hydration</p>
<p>PolyRex-Classic</p>					
	<p>PolyRex Optimo</p>	<p>Use Optional</p>	<p>Polymer ■ Powder ■ Liquid</p>	<p>Mixing unit Closed system with heated wetting area and integrated mixing pump</p>	<p>Application / benefits ■ Highly efficient polymer mixing ■ Reliable and dust-free ■ Very low powder consumption</p>
<p>PolyRex-Optimo</p>					
	<p>PolyRex Aero Mix</p>	<p>Use Optional</p>	<p>Polymer ■ Powder</p>	<p>Mixing unit Closed system with pneumatic powder conveyance, fans, water nozzles, mixing tank</p>	<p>Application / benefits ■ High air humidity ■ High ambient temperature</p>
<p>PolyRex-Aero-Mix</p>					



2 Metering Systems

2.1.16 Multi-Screw Feeder TOMAL®

Reduce costs with precision and reliability when metering dry products.

Capacity range 0.4 – 215 m³/h

Its unique construction makes the multi-screw feeder ideally suited for metering powders and granulates.



TOMAL® metering units are volumetric multi-screw feeders and can be integrated into almost every process, whether continuously or intermittently, into many applications in which solids need to be metered safely and precisely.

The metering unit is ideally designed and selected to your customer-specific requirements.

Your benefits

- Safe silo emptying
- Excellent dosing precision better than ± 1% with constant bulk weight/density
- Linear discharge curve

Technical Details

- Robust construction for low wear.
- Number of intermeshed and counter-rotating feeder screws, which form a blocking zone and thus prevent product on flow when at rest.
- Material extraction along the entire active inlet surface of the metering unit.
- Self-cleaning construction.

Field of application

- Waste water treatment
- Paper industry
- Flue gas cleaning
- Chemical industry
- Glass and ceramic industry

Options

- The volumetric TOMAL® metering unit can be disassembled in combination with weighing technology to form a gravimetric metering system. This is ideal with large fluctuations in bulk weight/density.
- Level sensors to detect bridge formation

Examples of typical metered products

Calcium hydroxide	Aluminium sulfate	Flue ash	Starch
Polymers	Talcum	Wood powder	Sodium hydrosulfite
Iron sulfate	Soap pellets	Plaster	Sodium bicarbonate
Potassium permanganate	Magnesium sulfate	Cement	Sodium carbonate
Urea	Magnesium oxide		Active carbon
Fluoride	Lignite coke HOK®		Iron oxide
Bentonite	Limestone meal		Zinc oxide



P_AC_0279_SW1

2 Metering Systems

2.2 Metering and drainage station DULCODOS® SAFE-IBC

2.2.1 Metering and drainage station DULCODOS® SAFE-IBC

Safety as a priority with the reliable metering of liquid chemicals.

Storage and drainage of IBCs up to 1,000 l – metering of chemicals up to 1,000 l/h

The metering and drainage station DULCODOS® SAFE-IBC provides your process with chemicals interruption-free. It conforms to the modified legislature for liquids harmful to water in accordance with the German Ordinance for Systems Handling Substances Harmful to Water AwSV.



DULCODOS® SAFE-IBC is a special metering and drainage station for Intermediate Bulk Containers (IBC) with almost complete residual drainage.

The IBC is positioned and fixed at the customer's side on the respective installation surface of the collecting pan slightly tilted forward. Featuring leak-proof safety couplings and hoses, the IBC is connected to an approx. 200-litre interim tank fitted to the left side of the collecting pan. Alternatively, the station can be ordered with a standpipe and tank volume of approx. 60 litres.

When changing the IBC, this buffer volume ensures an interruption-free process. The IBC change can also be planned better with a visual level indicator and a liquid level measurement with alarm message. The station is equipped with an inspection opening for maintenance purposes.

A compact metering station can be integrated in the front of the interim tank depending on process requirements for reliable metering. It is equipped either with one or two solenoid-driven metering pumps or with one motor-driven metering pump.

Larger metering stations can be configured as required and designed for side mounting on the wall or installation on the floor.

Your benefits

- Maximum operating safety:
- Excellent process reliability due to interruption-free metering in the process.
- Safe installation of an IBC on a special roll-under collecting pan construction. Any drops are reliably collected and cannot escape at the installation place.
- Almost complete residual drainage of the IBC.
- Interim tank with a volume of approx. 200 litres combined with an integrated metering station.
- Collecting pan based on general building authority certification by the German Institute of Building Technology (applied for).

Technical Details

- Robust welded construction of the PE-HD collecting pan with a total volume of 1,300 litres
- Internal steel-strengthened PE-HD reinforcement on all sides
- PE-HE interim tank holding approx. 200 l, alternatively PE-HD standpipe holding approx. 60 l as required
- For installation indoors at temperatures up to 35 °C
- Outer dimensions approx. 1,840 x 1,850 x 2,098 mm (W x D x H)
- Collecting pan with German Institute for Building Technology (DiBT) certification
- For chemicals with a density of up to max. 1.8 kg/dm³
- For liquids listed on German Institute of Building Technology media lists 40-1.1 and mineral acids up to 20%, inorganic lyes (no oxidising solutions of salts, such as hypochlorite), solutions of inorganic non-oxidising salts with a pH value of 6-8
- Installation surface for the IBC tilted forwards measuring approximately 1,010 x 1,620 (W x D) with grille (polyester resin) on a special load-bearing construction to withstand a maximum load of 2,000 kg, stop rail to the rear of the station and fixing block at the front
- Pallet substructure to roll under collecting pan with a height of approx. 100 mm
- Installation in earthquake zones 1 to 3 is possible in accordance with DIN 4149 with optional securing measures
- Connection of the IBC to the interim tank or standpipe:
 - Dual-acting PP/Viton quick-release couplings
 - Secure storage of the connection once uncoupled from the IBC in a collection tray recessed on the front
 - PVC spiral hose with wire coil, optionally also available in a PTFE material version
- The interim tank or the standpipe act as a compensation vessel for the volume of the IBC, although the communicating pipes principle technically rules out the possibility of overfilling

NEW



2 Metering Systems

- Equipment of the interim tank or standpipe:
 - Drain connector with stopcock for the IBC's hose connector
 - Suction-side connector to the metering station with stopcock
 - Connection for return of the safety overflow line
 - Visual level indicator
 - Continuous level measurement by liquid level sensors with alarm message
 - Screw lid acts as an inspection opening
 - Ventilation connectors
- Metering stations for all solenoid metering pumps and motor-driven metering pumps up to Sigma/ 3 can be integrated: DSUa mini, DSKa Sigma/ 1 - 3
- Metering stations DSUa, DSWb and customer-specific designs can be set up with side wall mounting and/or floor installation
- Fittings and seals in PVC/FKM, optionally in PP/FKM
- Also available as a mirror-image design
- A chemical vapour barrier with a vapour recovery line to the IBC can be added to the interim tank for gaseous media
- A liquid level measurement with ultrasound sensor can optionally be used

Field of application

- Metering of liquids in chemical and industrial production
- Potable water treatment
- Cooling water treatment
- Food & beverages
- Electroplating
- Paper industry

Design versions

	Order no.
DULCODOS® SAFE-IBC 200 L PE Standard	1106230
DULCODOS® SAFE-IBC 60 L PE Standpipe	1106231
DULCODOS® SAFE-IBC 200 L PE Standard mirror-inverted	1106232
DULCODOS® SAFE-IBC 60 L PE Standpipe mirror-inverted	1106233

Options

	Order no.
Version for gaseous media	1106613
Liquid level measurement with ultrasonic sensor	1107079
Drainage hose for IBC, PTFE	1107080



2 Metering Systems

2.3 Storage and process tanks

2.3.1 PE/PP storage tank, general



Safe and reliable handling of chemicals.

Useful capacity 500 l–50,000 l, indoor and outdoor installation

Our plastic storage tanks guarantee compliance with statutory specifications taking into account country-specific approvals, which regulate the production and operation of systems for storage and metering of environmentally-hazardous substances.

Production of plastic storage tanks to customers' specific requirements and in accordance with the test certification. Constructional design and production are in compliance with the construction and test guidelines as laid down by the German Institute for Building Technology (DIBT).

After specification of the key requirements, including fill medium, installation place, storage and ambient conditions, as well as service life, a statistical calculation of the storage tank volume is produced which then provides the technical basis for detailed construction drawings.

PE-HD and PP plate material is primarily used.

Your benefits

- Excellent process reliability of the products, thanks to 25 years of experience in the engineering and production of plastic storage tanks.
- Wide diversity of installation components and storage tank accessories
- Selection of a suitable material after testing its chemical resistance and process-specific requirements.
- Excellent manufacturing quality by the use of state-of-the-art plastics processing machines

Field of application

Suitable for the storage of chemicals. Applications include: Potable water and process water treatment, process technology, waste water technology, electroplating, swimming pool technology and exhaust air treatment.



2 Metering Systems

2.3.2 PE Storage Tank With General WHG Approval

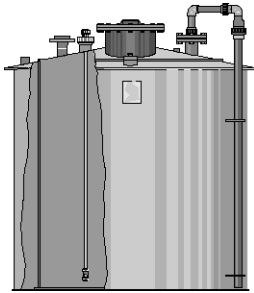

pk_3_014

The storage of chemicals hazardous for water (Water Hazard Class (WGK) 0 – 3) is subject to strict, regulatory requirements.

We are a specialist WHG company and supply storage tanks suitable for indoor and outdoor installation, up to a storage volume of 50 m³ in accordance with the statutory requirements in Germany.

Manufacturing is subject to external monitoring by the TÜV SÜD.

The storage tanks are fully available with monitoring accessories, filling level device, filling equipment, heating equipment, extraction and feeder assembly.

PE-HD Storage Tanks

- Test certificate Z-40.21-229 as per the WHG
- Design and production are in compliance with the construction and test regulations as laid down by the German Institute for Building Technology (DIBT)
- For operation at atmospheric pressure at an operating temperature of up to a maximum of 40 °C (media-dependent)
- Material polyethylene PE-HD
- For installation outdoors or indoors
- For installation in earthquake zones with an appropriate technical design
- For chemicals as per the DIBT media list

Usable volume 95% fill level l	Internal diameter mm	External diameter mm	Height of cylindrical section mm	Overall height mm	Weight empty kg
500	800	860	1,050	1,300	50
750	1,000	1,060	1,050	1,300	60
1,000	1,000	1,060	1,350	1,600	70
1,250	1,200	1,260	1,150	1,400	80
1,500	1,200	1,260	1,400	1,650	90
2,000	1,400	1,480	1,400	1,650	100
2,500	1,400	1,480	1,700	1,950	130
3,000	1,600	1,680	1,550	1,800	170
3,500	1,700	1,780	1,550	1,800	190
4,000	1,700	1,780	1,850	2,100	220
5,000	1,900	1,980	1,850	2,100	280
6,000	2,000	2,080	1,950	2,250	350
7,000	2,150	2,250	1,950	2,250	400
8,000	2,150	2,250	2,250	2,550	500
10,000	2,150	2,250	2,900	3,200	600
12,000	2,150	2,250	3,400	3,700	700

Common dimensions, special dimensions and other sizes on request.

PE-HD Collecting Pans

Usable volume 95% fill level l	Internal diameter mm	External diameter mm	Height of cylindrical section mm	Overall height mm	Weight empty kg
500	1,050	1,150	1,030	1,050	40
750	1,250	1,350	1,030	1,050	45
1,000	1,250	1,350	1,280	1,300	50
1,250	1,450	1,550	1,080	1,100	55
1,500	1,450	1,550	1,330	1,350	60
2,000	1,650	1,750	1,280	1,300	70
2,500	1,650	1,750	1,600	1,620	90
3,000	1,850	1,950	1,470	1,500	105
3,500	1,950	2,050	1,470	1,500	120
4,000	1,950	2,050	1,750	1,780	140
5,000	2,150	2,250	1,750	1,780	160
6,000	2,250	2,350	1,900	1,950	200
7,000	2,390	2,490	1,910	1,960	220
8,000	2,390	2,490	2,200	2,250	270
10,000	2,390	2,490	2,750	2,800	350
12,000	2,390	2,490	3,300	3,350	450

Common dimensions, special dimensions and other sizes on request.

2 Metering Systems

Our standard equipped storage tanks and collecting pans with approval marks

For indoor or outdoor installation; other internal fittings/accessories on request.

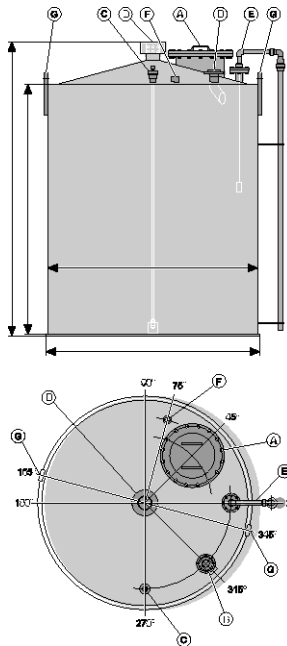

pk_3_046

Item	Quantity	Name	500 l - 1,250 l	1,500 l - 2,000 l	2,500 l - 3,500 l	4,000 l - 12,000 l
A	1	Handhole/manhole, bolted 1.4301	DN 250	DN 250	DN 500	DN 500
B	1	Filling connection with 45° inlet elbow	DN 32	DN 50	DN 50	DN 50
C	1	Sampling pipe PVC/EPDM	DN 15	DN 15	DN 15	DN 20
D	1	Vent pipe with dome	DN 80	DN 100	DN 100	DN 100
E	1	Rope-operated level indicator	DN 80/40	DN 80/40	DN 80/40	DN 80/40
F	1	Screwed socket for overfill protection	Rp 2"	Rp 2"	Rp 2"	Rp 2"
G	2	Crane lifting eye	-	yes	yes	yes

Collecting Pans for outdoor installation

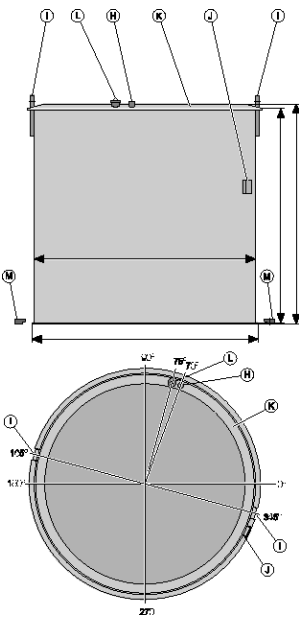

pk_3_047

Item	Quantity	Name	500 l - 1,250 l	1,500 l - 12,000 l
H	1	Leakage sensor support	Rp 2"	Rp 2"
I	2	Crane lifting eye	-	yes
J	1	Name plate	yes	yes
K	1	Rain collar	yes	yes
L	1	Inspection port	yes	yes
M	1	Floor claw set	yes	yes

Collecting Pans for indoor installation

Item	Quantity	Name	500 l - 1,250 l	1,500 l - 12,000 l
H	1	Leakage sensor support	Rp 2"	Rp 2"
I	2	Crane lifting eye	-	yes
J	1	Name plate	yes	yes



2 Metering Systems

2.3.3

Accessories according to the specifications of the Federal Water Act (WHG) and/or the Ordinance on installations for the handling of substances hazardous to water (VAwS)

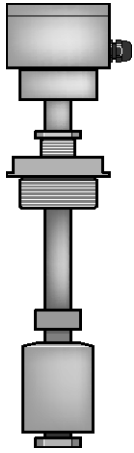

pk_3_037

Overfill protection with test certificate

Level probe T200 with float as max. limit level switch for connection to downstream transmitter, see transmitters with test certificate. Length 500 mm adjustable.

Order no.

Overfill protection with approval mark

1009334

Level probe T200 with float used as a max. limit level switch plus downstream transmitter and analysis electronics for 24 VDC with test certificate integrated in the connector head. Length 500 mm adjustable.

Order no.

Overfill protection with signal output and test certificate

1106258

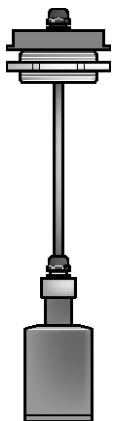

pk_3_038

Leak probe with test certificate

Leak detection system T200, consisting of level probe with float for connection to downstream transmitter, see transmitters with test certificate.

Order no.

Leakage sensor with approval mark

1009340

Leak detection system T200, consisting of level probe with float for connection and analysis electronics for 24 VDC with test certificate integrated in the connector head.

Order no.

Leak probe with signal output and test certificate

1106260

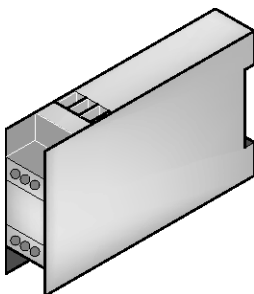

pk_3_040

Transmitter with test certificate

For in situ control cabinet installation, compatible with the leak probe and overfill protection

Order no.

Transmitter with test certificate 230 VAC / 50-60 Hz

1009348

Transmitter with test certificate 24 VDC

1023865

2 Metering Systems

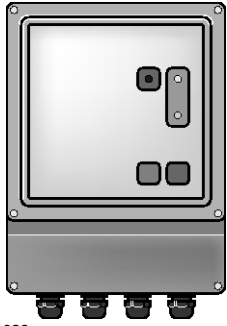

pk_3_039

Alarm indicator unit

For overflow protection and leakage sensor with approval mark incl. beacon light, signal horn and two transmitters.

Price on request.

	Order no.
Alarm signalling equipment with test certificate	1025437

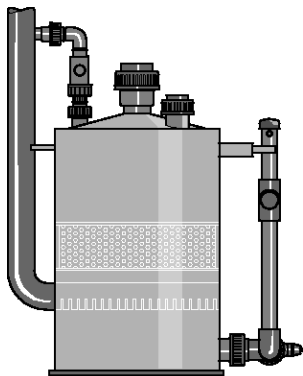

Absorption vessel

For ventilation of closed storage tanks.

Material: polyethylene PE-HD complete with connections, PVC/EPDM ball valve and fixed pipework to storage tank; sizes and prices according to tank volume and stored medium.

Price on request.

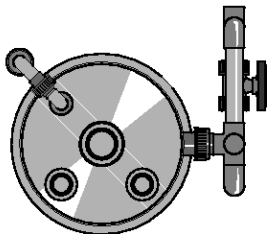

pk_3_041

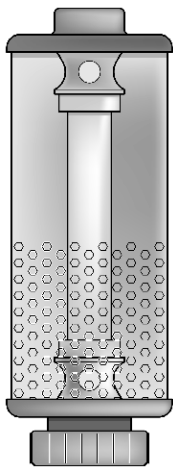

pk_3_042

Acid vapour separator

Size and combining agent according to tank volume and stored medium.

Price on request.



2 Metering Systems

2.3.4 Other Accessories

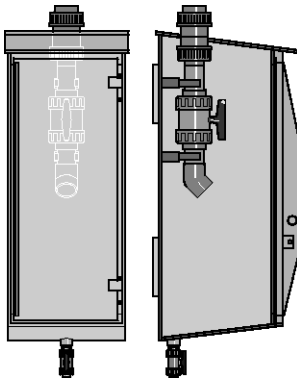

pk_3_043

Chemical filling station

Suitable for wall mounting on site

Material: Polyethylene PE-HD

Dimensions: approx. 420 x 420 x 1000 mm (L x W x H), including ball valve DN 50 PVC/EPDM, threaded connector DN 50 and drip tray with ball valve DN 25

PVC/EPDM connector: female thread Rp 2"

Other installations, including tank couplings, automatic fittings, heating system etc. are possible

Prices on request

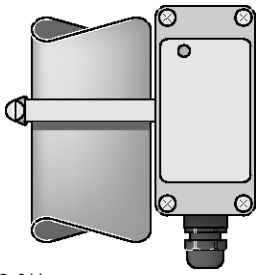

pk_3_044

Bistable changeover contact

With approval mark for fitting on rope-operated level indicator.

	Order no.
Bistable changeover contact	1009349



P_DO_0024_SW1

Storage tank heater

With temperature and level control as low flow contact, design and price on request, according to storage medium and tank volume

- Panel radiator with casing and support frame

Optionally with supplementary insulation of the storage tank

Price on request

2 Metering Systems

2.3.5

PP/PE process storage tank, customised

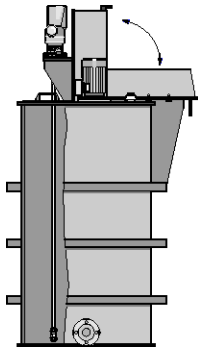

pk_3_015

System and process-technology requirements and specifications, and often special requirements demand specially tailored and custom-manufactured PP-PE storage tanks produced using special plate welding machines and bending machines.

Selection of a suitable plate material after checking its chemical resistance.

Additional inserts and attachments, like connecting nozzles, flanges, stirrers, salt dissolving baskets, bag dump equipment, absorption tanks, slanted and cone bottom, optimise and extend their functionality, permitting targeted adaptation of technical problems. A versatile programme of transducers and sensors can also be integrated.

We supply process storage tanks up to a storage volume of 50 m³

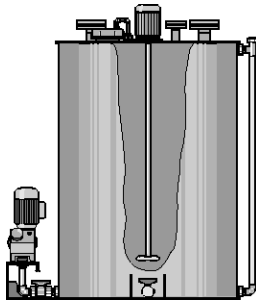

pk_3_016

Round Tanks

- Material: polyethylene PE-HD or polypropylene PP
- Bottom design: flat bottom, cone bottom, slanted bottom
- Roof design: flat roof, tapered roof or open, suitable for pressure-free operation at working temperatures of up to 80 °C
- Standard equipment: 2 crane lifting eyes on round tanks with usable volumes above 2000 litres
- Prices on request according to application

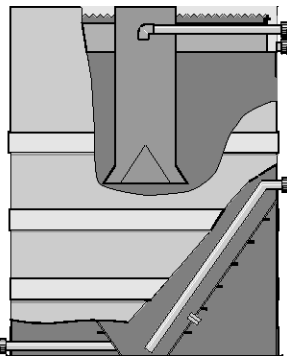

pk_3_017

Usable volume 95% fill level	Internal diameter	External diameter	Height of cylindrical section	Overall height
l	mm	mm	mm	mm
500	800	860	1,050	1,070
750	1,000	1,060	1,050	1,070
1,000	1,000	1,060	1,350	1,370
1,250	1,200	1,260	1,150	1,170
1,500	1,200	1,260	1,400	1,425
2,000	1,400	1,480	1,400	1,425
2,500	1,400	1,480	1,700	1,730
3,000	1,600	1,680	1,550	1,580
3,500	1,700	1,780	1,550	1,580
4,000	1,700	1,780	1,850	1,880
5,000	1,900	1,980	1,850	1,880
6,000	2,000	2,080	1,950	1,980
7,000	2,150	2,250	1,950	1,990
8,000	2,150	2,250	2,250	2,290
10,000	2,150	2,250	2,900	2,950
12,000	2,150	2,250	3,400	3,450

Common dimensions, special dimensions and other sizes on request.



2 Metering Systems

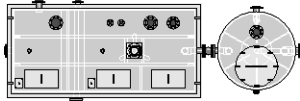
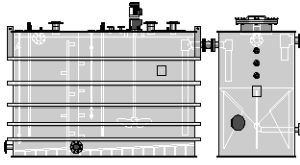

pk_3_048

Rectangular Tanks

- Material polyethylene PE-HD or polypropylene PP
- Floor design, flat floor or angled floor, covering the entire area
- Roof design, flat roof or open, suitable for operation at atmospheric pressure at working temperatures of up to 60 °C
- Steel pipe reinforcement on all sides, with PE or PP jacket
- Standard equipment: 4 lifting eyes above a rectangular storage tank with a usable volume of 2000 l
- Prices according to the application on request

Usable volume 95% fill level l	Internal dimensions (L x W x H)	External dimensions (L x W x H)
	mm	mm
500	950 x 750 x 750	1,100 x 900 x 770
750	1,000 x 1,000 x 800	1,150 x 1,150 x 820
1,000	1,000 x 1,000 x 1,060	1,150 x 1,150 x 1,080
1,250	1,250 x 1,000 x 1,060	1,400 x 1,150 x 1,080
1,500	1,500 x 1,000 x 1,060	1,750 x 1,250 x 1,090
2,000	1,500 x 1,250 x 1,130	1,750 x 1,500 x 1,160
2,500	1,750 x 1,250 x 1,210	2,000 x 1,500 x 1,240
3,000	1,750 x 1,250 x 1,450	2,000 x 1,500 x 1,480
3,500	1,750 x 1,500 x 1,410	2,000 x 1,750 x 1,440
4,000	2,000 x 1,500 x 1,410	2,250 x 1,750 x 1,440
5,000	2,500 x 1,500 x 1,410	2,750 x 1,750 x 1,440
6,000	2,500 x 1,750 x 1,450	2,750 x 2,000 x 1,480
7,000	2,500 x 1,750 x 1,700	2,750 x 2,000 x 1,730
8,000	2,500 x 2,000 x 1,700	2,750 x 2,250 x 1,730
10,000	3,000 x 2,000 x 1,760	3,350 x 2,350 x 1,800
12,000	3,500 x 2,000 x 1,810	3,850 x 2,350 x 1,850
15,000	4,000 x 2,000 x 2,000	4,350 x 2,350 x 2,050

Common dimensions, special dimensions and other sizes on request.



3 Filtration

3.1 Overview of Membrane Technology

Systems for membrane filtration

In water treatment, membrane filtration is the process for removing particles and salts in the water ensuring the lowest operating costs. ProMinent offers versatile and high-quality system technology in this field. This is complemented by the extensive ProMinent product range to produce customer-specific complete solutions.

Membrane filtration is a physical process to separate substances with the help of semi-permeable membranes. There are four types of processes, depending on the size of the particles/molecules to be removed:

- Microfiltration
- Ultrafiltration
- Nanofiltration
- Reverse osmosis

The following table shows the separation limits of the individual processes:

	Microfiltration	Ultrafiltration	Nanofiltration	Reverse osmosis
Particle size	> 0.1 µm	0.1 – 0.01 µm	0.01 – 0.001 µm	< 0.001 µm
Particle type	Suspended particles, colloidal turbidity, oil emulsions	Macromolecules, bacteria, cells, viruses, proteins	Low-molecular organic compounds, ions	Ions

ProMinent experts, with their detailed industry knowledge, are not only able to put together the optimum system for the relevant application but also deliver complete water treatment solutions from one source, supported by the extensive ProMinent product range.



3 Filtration

3.2 Ultrafiltration Systems

3.2.1 Performance Overview of Ultrafiltration

Ultrafiltration is a membrane process which is increasingly used in water treatment to separate undesired water components. Parasites, bacteria, viruses and high-molecular organic substances as well as other particles are retained.

The applications of ultrafiltration are widespread and may include different types of water.

Typical applications include drinking water, river water, process water, swimming pool water, salt water and waste water.

The tasks range from potable water purification to meet physical and microbiological limit values in accordance with the German Drinking Water Ordinance up to the pre-treatment of seawater for desalination by reverse osmosis.

The systems are matched to a specific task by individually selecting the membrane type and the operating mode. ProMinent uses extremely robust and resistant UF membranes and the dead-end principle to ensure optimisation with regard to investment costs, required space and operating costs. With this selection, all raw waters with the exception of waste water can be filtered largely without using chemicals.

The dead-end operation represents the standard operating mode. The raw water flows into the capillaries. The pure water (filtrate) passes through the membrane while the other constituents are retained on the surface of the membrane.

The constituents form a layer on the membrane. The membrane is backwashed fully automatically in regular intervals to remove the filter cake.

Ultrafiltration systems basically consist of:

- Stainless steel or high-grade coated steel rack
- Pre-filter to protect the membranes, if required. This filter can optionally be designed as a backwashing filter.
- UF membrane modules
- Pneumatically controlled valves made of high-quality materials
- Electronic pressure measurement
- Filtration pump and backwash pump with frequency converter made of suitable high-quality materials
- Magnetically inductive flow metering to control the flow rates for filtration and backwashing.
- Integrated filling system for the backwash water tank. The backwash water tank is also integral to small systems. With larger systems, tanks from our product range can be integrated or an application-specific solution found depending on the customer's requirements.
- PLC control with touch screen panel or microprocessor control unit.
The PLC control simultaneously monitors all important parameters, such as pressure, pressure difference and flow rates. This ensures that the membranes are optimally protected. The control of pre- and post-treatment processes can be integrated, if required.

Advantages of ultrafiltration systems

- Filtrate values of less than 0.1 NTU independent of the turbidity of the raw water.
- Molecular weight cut off of the membranes (MWCO) approx. 100 kDa (kilodalton).
- Best possible retention rates for bacteria (99.9999%) and viruses (99.99% based on MS2 phages).
- Very easy to use and simple to combine with other systems owing to PLC Programmable Logic Controller with touch screen.
- Optimum operating processes due to modern measuring and control technology.
- Complete solutions with perfectly coordinated pre- and post-treatment are available on request.



3 Filtration

Areas of application of ultrafiltration systems

Typical areas of application include the removal of particles, turbidity and pathogens in public or private potable water supplies. Ultrafiltration is predominantly used for the treatment of fresh water, in particular surface water, spring water or well water. In principle, brackish water and salt water can also be treated, e.g. as pre-treatment for subsequent desalination by nanofiltration or reverse osmosis. Further areas of application include the treatment of swimming pool water, process water from the food and beverage industry.

A typical general system layout is shown below:

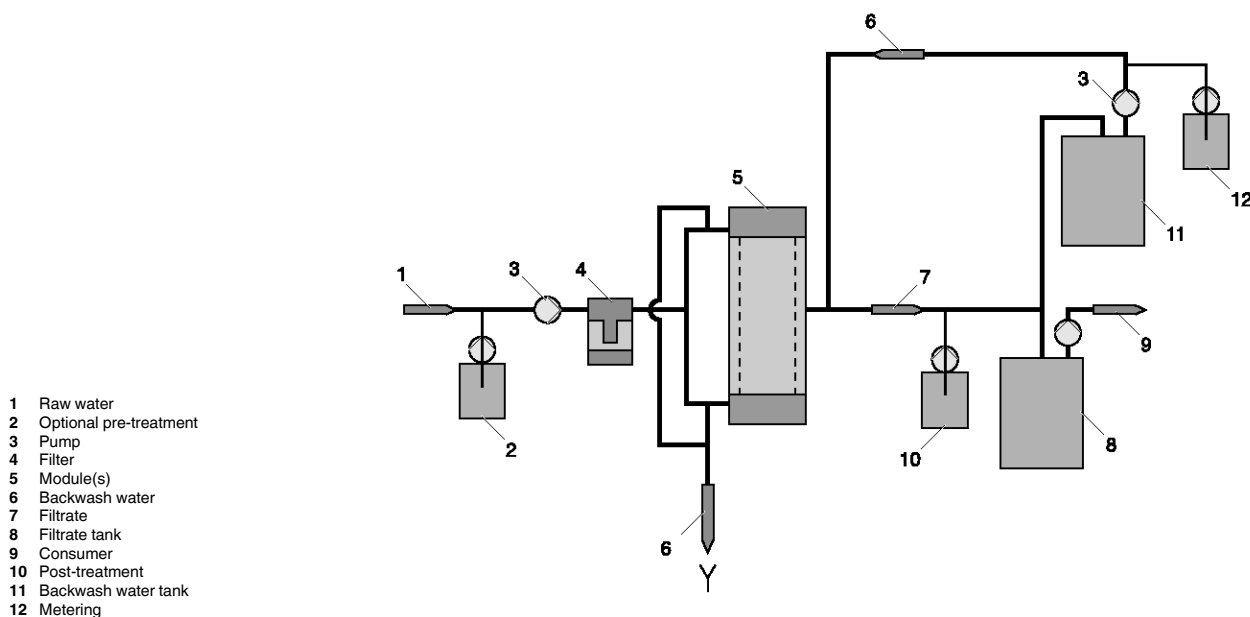

P_PMA_UO_0008_SW

Our engineers use their wide experience in water treatment to determine the ultrafiltration system to meet the specific raw water requirements. If desired and/or required, the best-suited pre- and post-treatment is also defined. Numerous further ProMinent® products are available for this purpose. Thus, customers are offered a complete package of solutions from one single source.

The filtration capacity of ultrafiltration systems ranges from 1 to 80 m³/h. Other capacities are available on request. Please contact us, we will be glad to assist you.



3 Filtration

3.2.2 Questionnaire on the Design of a UF System

- Application:**
- Drinking water production
 - Process water for food/beverage industry
 - Circulation water for swimming pools
 - Flushing water for swimming pools
 - Other: _____
- Type of raw water**
- Drinking water
 - Surface water (lake, river water)
 - Source water
 - Ground water
 - Brackish water, sea water

Design principles: (please state maximum (peak), minimum and average values)

- | | |
|--|--|
| Clear water requirement: _____ m ³ /h | Chloride: _____ ppm |
| Clear water requirement: _____ m ³ /day | Iron in solution: _____ ppm |
| Temperature: _____ °C | Particular iron: _____ ppm |
| Turbidity: _____ NTU | Manganese in solution: _____ ppm |
| COD: _____ ppm | Particular manganese: _____ ppm |
| TOC/DOC: _____ ppm | Fluctuations? Yes <input type="checkbox"/> No <input type="checkbox"/> |
| Total hardness: _____ °dH | |

Remarks (current pre-treatment, special requirements)

P_PMA_MT_0001_SW



3 Filtration

3.2.3

Ultrafiltration Systems Dulcoclean® UF

Pure, crystal-clear potable water at all times

8 – 75 m³/h filtrate output



Ultrafiltration system Dulcoclean® UF reliably and safely uses membrane technology to remove turbidity, particles and microbiological contamination.

The ultrafiltration system Dulcoclean® UF is used in water treatment to separate the finest particles and turbidity. The membranes provides a sterile barrier, so that bacteria, parasites and viruses are safely removed from the water – even with fluctuating water quality, as can occur after heavy rainfall. The quality of the filtrate remains consistently good! In potable water treatment, the filtration process is ideally used before final disinfection.

In regular cycles, back washes are performed to prevent blockages in the modules. Cleaning is supported by the addition of chemicals, where necessary, and adapted to the raw water quality present.

Your benefits

- Very high retention rates for bacteria and viruses (based on MS2 phages) of 99.999% and/or 99.99%
- Minimal consumption of energy and water by economical dead-end operation
- Maximum operational reliability due to fully automated system control with PLC and data storage and by user-friendly touch panel with clear process visualisation
- All relevant events are recorded electronically for system optimisation and can be easily evaluated.
- Constant filtrate output and efficient back flushing by speed-controlled filtration and backwash pumps
- Complete solutions with perfectly coordinated pre- and post-treatment and waste water treatment

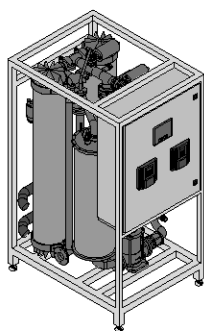

P_PMA_MT_0003_SW

Technical Details

- Compact design can be installed in existing plant rooms or in a container
- Fitted with extremely resistant and shatter-proof PES ultrafiltration membranes

Field of application

- Municipal potable water treatment: Potable water is produced from surface, spring or well water.
- Food and beverage industry: Improved water quality.
- Desalination: Pre-treatment for downstream desalination plants (RO, NF or ion exchange)

Dulcoclean® ultrafiltration systems are suitable for use with the following water values in the feed:

pH range	3.0 ... 12.0
Free chlorine	< 1.2 mg/l
Turbidity	0.5 ... 30 NTU
DOC	0.5 ... 12 mg/l
Suspended solids	50 mg/l

Deviating values influence the performance data and require a separate design of the system. Please contact our experts.

Dulcoclean® type	Filtration capacity* at 15 °C m³/h	Approx. backwash water per rinse m³	Raw/rinsing water connector [Rp/DN]	Approx. dimensions LxWxH [mm]
UF 2	8 - 15	0.34	1 1/2 "/2 "	1,200 x 920 x 2,100
UF 3	12 - 22.5	0.51	2 "/DN 65	1,600 x 920 x 2,100
UF 4	16 - 30	0.68	2 "/DN 80	1,600 x 920 x 2,100
UF 6	24 - 45	1.02	DN 65/DN 80	2,000 x 920 x 2,100
UF 8	32 - 60	1.36	DN 80/DN 100	2,400 x 920 x 2,100
UF 10	40 - 75	1.70	DN 100/DN 125	2,800 x 920 x 2,100

* Filtrate performance depends on the water quality

Systems with filtration capacity of more than 18 m³/h are designed on a project basis. Offers are available on request. Please contact us.

Optionally available are a fully automatic neutralisation system for the treatment of acid and alkaline backwash water, an integrity test as well as customised data logging.



3 Filtration

3.3 Nanofiltration Systems

3.3.1 Nanofiltration System Dulcosmose® NF



Partial desalination for industrial applications - compact and cost-effective

Permeate outputs from 1 to 50 m³/h, higher outputs possible on request

As a nanofiltration system, the Dulcosmose® NF, a compact and value-for-money unit, can take over partial desalination in industrial applications. Maximum permeate output at low operating pressures ensures low investment and operating costs thanks to the latest "ultra low pressure" membrane.

Equipped with the latest generation of "ultra low-pressure" membranes, this system achieves maximum permeate performance with low operating pressures and high outputs, thereby lowering investment and operating costs.

As the system runs with low operating pressures, the entire system can be fitted with inexpensive PVC pipework. This system is also available with an integral, semi-automated cleaning system and permeate and/or raw water flushing option.

The system can easily be adapted to meet specific customer requirements. Pipework material, other types of membrane for enhanced salt retention or discolouration, integration of measuring and control technology (such as conductivity, redox potential or pH measurement) and metering technology (in pre- and post-treatment) to visualisation of the entire process with peripheral components on a PLC.

Your benefits

- Efficient operation with a low pressure membrane with outputs of up to 85% and high salt retention rates of up to 90% (depending on the type of membrane used).
- Reduced maintenance and service costs, as well as long membrane service lives, thanks to integrated cleaning concepts and flushing options.
- Optional permeate flushing of the entire system, including the membranes, after switching off to avoid deposits and extend the life of the membranes.
- Best ProMinent manufacturing quality: High proportion of in-house manufacturing.
- Pure quality: Use of long-life, high-quality components.
- Service-friendly construction of systems on a corrosion-resistant powder-coated steel or stainless steel frame.
- Simple and safe to operate: Microprocessor control with direct connection option for peripheral system components and integrated conductivity measurement with plain text display in the graphic display.
- One-stop shop: no interface problems, smooth running with short times between definition of the task to joint commissioning and on-site system supervision with our global subsidiaries.

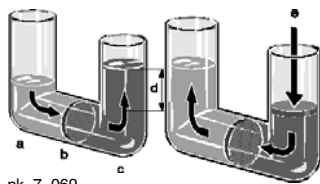

pk_7_069 pk_7_068

a Diluted solution (permeate)
 b Semi-permeable membrane
 c Concentrated solution (concentrate)
 d Hydrostatic head corresponding to the osmotic product
 e Pressure

Osmosis Nanofiltration

Technical Details

- Turnkey systems constructed on a high-quality, double powder-coated steel or stainless steel frame.
- Highly efficient low-pressure membranes with maximum output and system retention rates, built into epoxy-glass resin or stainless steel pressure pipes
- Pre-filter 5 µm with manometer for determining differential pressure
- Pressure switch to protect the high-pressure pump
- Flow meter to display permeate, concentrate and concentrate return volume
- Semi-automatic cleaning system for chemical module cleaning for long module service lives
- Central control for the entire system and peripheral components by the company's own microprocessor controller with graphic display and integrated temperature-compensated conductivity measurement.
- Optional permeate flushing of the entire system, including the membranes, after switching off
 - 2 switching inputs for level control of the cleaning tank
 - 2 switching inputs for level control of the permeate tank
 - Pause switching input for external On/Off
 - External fault switching input
 - Temperature measuring input (Pt 100)
 - Active permeate valve output (filling of cleaning tank)
 - Active output for flushing valve for initial permeate disposal (depending on conductivity), raw water, permeate and interval flushing (idle time management)
 - Active output for controlling a metering pump (anti-scalant)
 - Analogue output 0/4...20 mA conductance
- Optional industrial PLC with touch panel and process visualisation

3



3 Filtration

Field of application

- Low-cost alternative to reverse osmosis systems for special desalination tasks, such as the elimination of multiple charged ions or the removal of dyes
- Partial water softening or water softening in public drinking water
- Partial desalination in the chemical and pharmaceutical industry, food and beverage industry, metal processing industry and in electroplating

Nanofiltration is based on the same principle as reverse osmosis. The difference: The separation limit is slightly lower. Admittedly this type of membrane filtration retains ions dissolved in water, but to a significantly lesser extent than with reverse osmosis. Ultimately that saves operating costs.

Typical salt retention rates are around 80 – 90%. Multi-value ions (e. g. Ca and Mg) are retained better than single-value ions (e. g. Na, K) so that nanofiltration systems are often also used as an alternative to traditional water softening.

In principle with nanofiltration, the raw water to be softened is introduced into a chamber, separated by a semi-permeable membrane. An artificial pressure is generated in the chamber against the osmotic pressure gradient. The membrane is permeable to pure water and smaller ions. All other components of the water are retained. This produces partially softened water (permeate) and a concentrated solution (concentrate). ProMinent uses high-quality nanofiltration membranes for this process.



3 Filtration

3.4 Reverse Osmosis Systems

3.4.1 Performance Overview of Reverse Osmosis

Reverse osmosis is a sub-sector within membrane filtration. It is the process with the highest separation limit and represents the reversal of the natural process of osmosis. It is therefore used as a method for desalinating aqueous solutions. With suitable high-performance membranes, it is possible today to remove over 99% of all salts from an aqueous solution.

In principle with reverse osmosis, the raw water to be softened is introduced into a chamber, separated by a semi-permeable membrane. An artificial pressure is generated in the chamber against the osmotic pressure gradient. As the membrane is only permeable to pure water, not to the ions and other particles dissolved in it, a proportion of pure desalinated water (permeate) and a proportion of concentrated solution (concentrate) is produced from the raw water. ProMinent uses high-quality low-pressure membranes for this process.

Basically, Dulcosmose® Reverse Osmosis Systems Consist of:

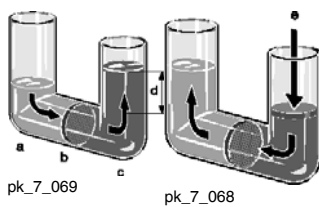

pk_7_069
pk_7_068

a Diluted solution (permeate)
b Semi-permeable membrane
c Concentrated solution (concentrate)
d Hydrostatic head corresponding to the osmotic product
e Pressure

Osmosis Reverse Osmosis

- Stainless steel, PP or powder-coated steel frame
- Pre-filter 5 µm
- High-quality inlet valve, made of appropriate materials, depending on the salt content of the raw water
- Pressure switch to protect the high-pressure pump
- High-pressure pump, made of suitable high-grade materials, depending on the salt content of the raw water
- Low-pressure membranes, designed as spiral winding modules, integrated into epoxy-glass resin pressure pipes
- Float flow meter and manometer
- Stainless steel control and regulating valves to regulate pressure and concentrate
- ProMinent's own conductivity sensor and reverse osmosis control with diverse programming options also for controlling external pre- or post-treatment components
- Semi-automatic chemical cleaning system

Advantages of Dulcosmose® Reverse Osmosis Systems

- Simple and reliable operation, thanks to modern microprocessor control with integrated conductivity measurement and clear text display of the operating status
- Efficient operation with pure water output of up to 85% and separation of more than 99% of dissolved ions
- Minimal energy consumption by the use of "low energy" reverse osmosis membranes and energy recovery from the concentrate flow (salt water desalination)
- Long service lives of the membranes, thanks to integrated cleaning concept and permeate and/or raw water flushing option
- Well thought-out, service-friendly construction of the systems on stainless steel or PP frames or made of powder-coated steel
- Minimal investment and operating costs, as components are used, optimised and matched to the individual case
- On request, complete solutions with precisely coordinated pre- and post-treatment, such as ProMinent metering and measuring and control technology, i.e. simple networking, perfect operation and overall monitoring of the different components of the system

3 Filtration

Applications of Dulcosmose® Reverse Osmosis Systems

Typical applications are desalination duties in municipal or private potable water supply, in the chemical and pharmaceutical industries, food and beverage industry, metal processing industry, electroplating, in boiler feed water treatment and in power stations, for example.

A typical general plant diagram is shown below:

- 1 Raw water
- 2 Filter
- 3 Pump
- 4 Module(s)
- 5 Concentrate
- 6 Permeate
- 7 Permeate tank
- 8 User
- A Pre-treatment
- B Reverse osmosis
- C Post-treatment

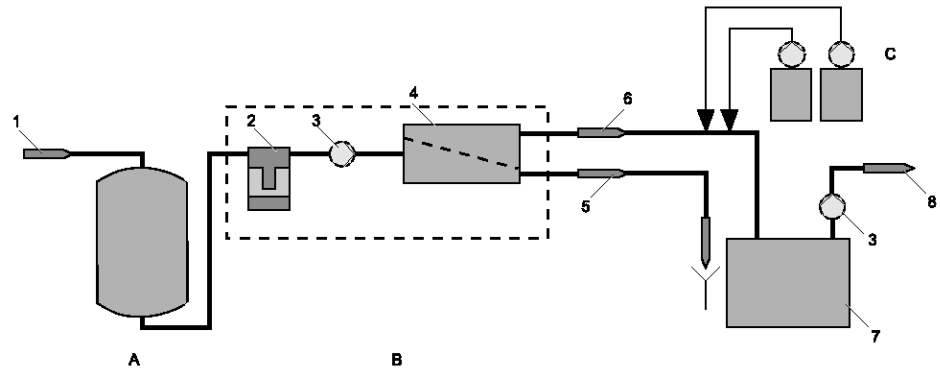

pk_7_067

Basically, three types of raw water with different salt contents can be considered for desalination:

- Potable water (typically up to 1,000 mg/l)
- Brackish water (typically up to 2,000 - 5,000 mg/l)
- Sea water (typically higher than 35,000 mg/l)

Our engineers use their years of experience in the treatment of this raw water to determine - based on the particular raw water analysis - the optimum version of reverse osmosis plant for the customer. At the same time, the most suitable pre-treatment and post-treatment stages are selected using other ProMinent® products. So a complete package is put together for the customer, from a single source. One of our specialities here is the supply of complete plants installed in a standard transport container.

ProMinent also has wide experience in building other special plants, e.g. two-pass plants for higher permeate quality requirements. Please contact us - we'll be happy to advise you.

Type	ecoPRO	TW	BW	SW
Permeat-output [m³/h]	50			
	25			
	10			
	5			
	2,5			
	1			
	0,5			
	0,25			
	0,1			
Salinity Drinking water	< 1.000 mg/l	< 1.000 mg/l	< 5.000 mg/l	< 40.000 mg/l

P_PMA_MT_0004_C



3 Filtration

3.4.2 Questionnaire on the Design of an RO System

Clean water requirement: _____ m³/h
 Clean water requirement: _____ m³/day
 Operating hours: _____ h/day
 Required clean water pressure: _____ bar
 Raw water temperature, min./max.: _____ °C

Required quality of clean water:

Conductivity: _____ µS/cm
 pH value: _____

Bacteriological quality:

Drinking Water Directive
 Germ-free and sterile

Intended use of clean water:

Type of raw water:

Drinking water
 Well water
 Brackish water
 Lake water
 or _____

Fluctuations: yes
 no

State fluctuations:

Conductivity: _____ µS/cm
 pH value: _____
 Ca: _____ mg/l
 Mg: _____ mg/l
 K: _____ mg/l
 Na: _____ mg/l
 Ba: _____ mg/l
 Sr: _____ mg/l
 Fe: _____ mg/l
 Mn: _____ mg/l
 Al: _____ mg/l

Available space HxWxD: _____ m
 Location of the system: _____ Floor
 Location of the users: _____ Floor
 Existing clean water tank: _____ m³
 Existing clean water pump: _____ m³/h
 _____ bar
 Lift yes
 no

H x W x D: _____ mm

Door dimensions

H x W _____ mm

Crane on site: yes
 no

Lifting capacity: _____ t

Raw water pressure: _____ bar

Raw water connection: _____ "

Clean water pipes available yes
 no

Material: _____ Ø
 _____ "

Mains voltage: _____ V/Hz

HCO₃: _____ mg/l

SO₄: _____ mg/l

Cl: _____ mg/l

NO₃: _____ mg/l

F: _____ mg/l

PO₄: _____ mg/l

CO₂ (free): _____ mg/l

SiO₂: _____ mg/l

COD*: _____ mg/l

*COD = chemical oxygen demand

3



3 Filtration

3.4.3

Reverse Osmosis System Dulcosmose® TW

Potable water desalination for industrial applications - compact and cost-effective

Permeate output 0.1 – 50 m³/h



Reverse osmosis system Dulcosmose® TW is the all-purpose model for modern potable water desalination. Maximum permeate output at low operating pressures ensures low investment and operating costs.

As the system runs with low operating pressures, the entire Dulcosmose® TW can be fitted with inexpensive PVC pipework. This system is also available with an integral, semi-automated cleaning system and permeate and/or raw water flushing option. Equipped with the latest generation of "ultra low-pressure" membranes, this system achieves maximum permeate output with low operating pressures, thereby lowering investment and operating costs.

The system is very adaptable to specific customer requirements. Pipework material, other types of membrane for enhanced salt retention, integration of measuring and control technology and metering technology to visualisation of the entire process with peripheral components via a PLC.

Your benefits

- Efficient operation with low-pressure diaphragms with outputs of up to 85 % and high salt retention rates of up to more than 99% (depending on the type of diaphragm used)
- Reduced maintenance and service costs as well as long diaphragm service lives, thanks to integrated cleaning concepts and flushing options, such as permeate flushing
- Service-friendly construction of systems on a corrosion-resistant powder-coated steel, stainless steel frame or PP frame
- Simple and safe to operate: Control with direct connection option for peripheral system components and integrated conductivity measurement with plain text display in the graphic display
- One-stop shop: no interface problems, smooth running with short times between definition of the task to joint commissioning and on-site system supervision with our global subsidiaries.

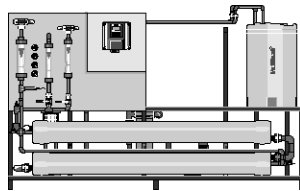

pk_7_064

Technical Details

- Turnkey systems constructed on a high-quality, double powder-coated steel or stainless steel frame
- Highly efficient low-pressure membranes with maximum output and system retention rates of over 99% integrated in epoxy-glass resin pressure pipes
- Pre-filter 5µm with manometer for determining differential pressure
- Pressure switch to protect the high-pressure pump
- Flow meter to display permeate, concentrate and concentrate return volume
- Semi-automatic cleaning system for chemical module cleaning for long module service lives
- 2 switching inputs for level control of the cleaning tank
- 2 switching inputs for level control of the permeate tank
- Pause switching input for external On/Off
- External fault switching input
- Temperature measuring input (PT 100)
- Active permeate valve output (filling of cleaning tank)
- Active output for flushing valve for initial permeate disposal (depending on conductivity), raw water, permeate and interval flushing (idle time management)
- Active output for controlling a metering pump (anti-scalant)
- Analogue output 0/4...20 mA conductance
- Optional industrial PLC with touch panel and process visualisation

Field of application

- Power plants: Provision of boiler feed water
- Electroplating / metal processing industry: Provision of rinsing water
- Beverage industry: Provision of rinsing water, product water and process and return dilution water
- Food industry: Provision of rinsing water and process water
- Chemical industry: Provision of rinsing water and process water
- Provision of rinsing water and process water for laboratory purposes and industrial rinsing machines
- Pure water for laboratory applications, hospital uses (autoclaves, high-speed steam generators)
- Feed water for cooling and air conditioning plants (air humidification and air scrubbers)
- Process water in printing plants, the pharmaceutical or cosmetics industry



3 Filtration

The product range Dulcosmose® TW was designed for the following values in feed water:

Max. salt content PRO 0010TW – 0055TW	650 mg/l
Max. salt content PRO 0060TW – 5000TW	1,000 mg/l
pH range	3.0 ... 10.0
Silt density index max.	3
Free chlorine max.	0.1 mg/l
Total Fe, Mn max.	0.2 mg/l
Total hardness max.	0.1 °dH
Bacteria count max.	100 KBE/ml
Turbidity max.	0.5 NTU
COD max.	5 mg/l**

* Differing salinities affect the performance data accordingly

** As O₂

Systems with 2.5 or 4" membranes, system salt retention 90-97%

Plant	Permeate capacity at 15 °C water temperature l/h	Number of 2.5" and 4" membranes No.	Connected load kW	Dimensions H x W x D mm	Order no.
PRO 0020TW	200	2	0.55	1,400 x 500 x 320	1104536
PRO 0030TW	300	1	1.10	1,500 x 600 x 400	1104537
PRO 0055TW	550	2	1.10	1,500 x 600 x 400	1104539
PRO 0060TW	600	2	1.50	1,650 x 700 x 720	1104540
PRO 0090TW	900	3	1.50	1,650 x 700 x 720	1104541
PRO 0120TW	1,200	4	1.50	1,650 x 700 x 720	1104542
PRO 0150TW	1,500	5	2.20	1,650 x 700 x 720	1104543
PRO 0180TW	1,800	6	2.20	1,750 x 2,600 x 750	1106338
PRO 0240TW	2,400	8	3.00	1,750 x 2,600 x 750	1106340
PRO 0270TW	2,700	9	3.00	1,750 x 3,500 x 750	1106342

Systems with 8" membranes, system salt retention 90-97%

Plant	Permeate capacity at 15 °C water temperature l/h	Number of 8" membranes No.	Connected load kW	Dimensions H x W x D mm	Order no.
PRO 0400TW	4,000	4	3.0	1,800 x 3,000 x 1,000	on request
PRO 0500TW	5,000	5	4.0	1,800 x 4,000 x 1,000	on request
PRO 0600TW	6,000	6	4.0	1,800 x 4,000 x 1,000	on request
PRO 0700TW	7,000	6	5.5	1,800 x 4,000 x 1,000	on request
PRO 0800TW	8,000	7	5.5	1,800 x 4,000 x 1,000	on request
PRO 0900TW	9,000	7	7.5	1,800 x 4,000 x 1,000	on request
PRO 1000TW	10,000	8	11.0	1,800 x 3,000 x 1,000	on request
PRO 1100TW	11,000	9	11.0	1,800 x 4,000 x 1,000	on request
PRO 1200TW	12,000	10	11.0	1,800 x 4,000 x 1,000	on request
PRO 1300TW	13,000	11	11.0	1,800 x 4,000 x 1,000	on request
PRO 1400TW	14,000	12	11.0	1,800 x 4,000 x 1,000	on request
PRO 1500TW	15,000	12	11.0	1,800 x 4,000 x 1,000	on request
PRO 2000TW	20,000	18	11.0	1,800 x 7,000 x 1,200	on request
PRO 2500TW	25,000	24	15.0	1,800 x 7,000 x 1,200*	on request
PRO 3000TW	30,000	28	18.5	1,800 x 7,000 x 1,200*	on request
PRO 4000TW	40,000	34	22.0	1,800 x 7,000 x 1,200*	on request
PRO 5000TW	50,000	48	22.0	1,800 x 7,000 x 1,200*	on request

* Separate cleaning tank

On request, these plants can also be supplied with different membrane types for further salt rejection, and with measuring and control equipment (conductivity, ORP, pH measurement) and metering equipment (in pre-treatment and post-treatment).



3 Filtration

3.4.4

Reverse Osmosis System Dulcosmose® BW

Brackish water is transformed into drinking water

Permeate output 2,000 – 50,000 l/h



Reverse osmosis system Dulcosmose® BW is the standard model for the modern desalination of brackish water. Equipped with the latest generation of "high rejection low-pressure" membranes, this system achieves maximum permeate output with moderate operating pressures, thereby lowering investment and operating costs.

A reverse osmosis system of type of BW has PVC pipework on the low-pressure side. The system has high-grade stainless steel (type DIN 1.4571) on the high-pressure side. Stainless steel pipes are welded under shielding gas and a forming gas atmosphere and subsequently passivated in a pickling bath. The integrated semi-automatic cleaning system with permeate and/or raw water flushing ensures exceptionally long membrane service lives, as scaling and fouling effects are minimised. The system is very adaptable to specific customer requirements. Pipework material, other types of membrane for enhanced salt retention, integration of measuring and control technology and metering technology to visualisation of the entire process with peripheral components via a PLC.

Your benefits

- Efficient operation with low pressure membranes with maximum output and salt retention rates of up to over 99 %
- Reduced maintenance and service costs as well as long membrane service lives, thanks to integrated cleaning concepts and flushing options
- Service-friendly construction of systems on a corrosion-resistant powder-coated steel or stainless steel frame
- Simple and safe to operate: Central control of the entire system by microprocessor controller or industrial PLC with touch panel and process visualisation.
- Application-optimised design taking into account economic aspects, such as the durability of the membranes, energy efficiency and process automation
- One-stop shop: no interface problems, smooth running with short times between definition of the task to joint commissioning and on-site system supervision with our global subsidiaries

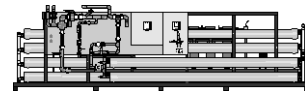

pk_7_065

Technical Details

- Turnkey systems constructed on a high-quality, double powder-coated steel or stainless steel frame.
- Highly efficient low-pressure membranes with maximum output and system retention rates of over 99% integrated in epoxy-glass resin pressure pipes
- Pre-filter 5µm with manometer for determining differential pressure
- Pressure switch to protect the high-pressure pump
- Flow meter to display permeate, concentrate and concentrate return volume
- Semi-automatic cleaning system for chemical module cleaning for long module service lives
- 2 switching inputs for level control of the cleaning tank
- 2 switching inputs for level control of the permeate tank
- Pause switching input for external On/Off
- External fault switching input
- Temperature measuring input (Pt 100)
- Active permeate valve output (filling of cleaning tank)
- Active output for flushing valve for initial permeate disposal (depending on conductivity), raw water, permeate and interval flushing (idle time management)
- Active output for controlling a metering pump (anti-scalant)
- Analogue output 0/4...20 mA conductance
- Optional industrial PLC with touch panel and process visualisation

Field of application

- Decentralised, public or private supply of potable water.



3 Filtration

The product range Dulcosmose® BW was designed for the following values in feed water:

Salt content max.	5,000 mg/l*
pH range	3.0 ... 10.0
Silt density index max.	3
Free chlorine max.	0.1 mg/l
Total Fe, Mn max.	0.2 mg/l
Total hardness max.	water must be chemically stabilised
Bacteria count max.	100 KBE/ml
Turbidity max.	0.5 NTU
COD max.	5 mg/l**

* Deviating salt contents have a corresponding influence on the performance data.

** As O₂

Systems with 8" membranes, system salt retention 95-99%

Plant	Permeate capacity at 25 °C water temperature l/h	Number of 4" and 8" membranes No.	Connected load kW	Dimensions H x W x D mm
PRO 0200BW	2,000	9	4.0	1,800 x 3,500 x 750
PRO 0300BW	3,000	3	5.5	1,800 x 4,000 x 1,000
PRO 0400BW	4,000	4	5.5	1,800 x 3,000 x 1,000
PRO 0500BW	5,000	5	5.5	1,800 x 4,000 x 1,000
PRO 0600BW	6,000	6	7.5	1,800 x 4,000 x 1,000
PRO 0700BW	7,000	7	7.5	1,800 x 4,000 x 1,000
PRO 0800BW	8,000	8	15.0	1,800 x 4,000 x 1,000
PRO 0900BW	9,000	9	15.0	1,800 x 4,000 x 1,000
PRO 1000BW	10,000	10	15.0	1,800 x 4,000 x 1,000
PRO 1100BW	11,000	11	15.0	1,800 x 4,000 x 1,000
PRO 1200BW	12,000	12	15.0	1,800 x 5,000 x 1,000
PRO 1300BW	13,000	13	15.0	1,800 x 6,000 x 1,000
PRO 1400BW	14,000	14	15.0	1,800 x 5,000 x 1,000
PRO 1500BW	15,000	15	18.5	1,800 x 5,000 x 1,000
PRO 2000BW	20,000	21	18.5	1,800 x 6,000 x 1,200
PRO 2500BW	25,000	26	30.0	1,800 x 6,000 x 1,200*
PRO 3000BW	30,000	29	30.0	1,800 x 6,000 x 1,200*
PRO 4000BW	40,000	42	45.0	1,800 x 7,000 x 1,200*
PRO 5000BW	50,000	51	60.0	1,800 x 7,000 x 1,200*

* Separate cleaning tank

On request, these plants can also be supplied with different membrane types for other salt rejection, and with measuring and control equipment (conductivity, ORP, pH measurement) and metering equipment (in pre-treatment and post-treatment).





Salt water is transformed into drinking water.

Permeate output 780 – 29,000 l/h

The reverse osmosis system Dulcosmose® SW is the standard model for modern desalination of salt water. Equipped with the latest generation of "high rejection low-pressure" membranes, this system achieves maximum permeate output with moderate operating pressures, thereby lowering investment and operating costs.

A reverse osmosis system of type of SW has PVC pipework on the low-pressure side. The high-pressure side of the system has a potable water-compatible, highly corrosion-resistant inner seal due to the high NaCl content. The integrated semi-automatic cleaning system with permeate and/or raw water flushing ensures exceptionally long membrane service lives, as scaling and fouling effects are minimised. The system can be adapted with ease to specific customer requirements. Pipework material, other types of membrane for enhanced salt retention, integration of measuring and control technology and metering technology to visualisation of the entire process with peripheral components via a PLC. Everything can be selected at random. Optional for all systems: They can be fitted with a system for energy recovery from the concentrate flow. The latest generation of what are known as pressure controllers is used.

Your benefits

- Integrated energy recovery system based on state-of-the-art pressure controllers
- Efficient operation with low pressure membranes with outputs of up to 50% and high salt retention rates of up to over 99%
- Reduced maintenance and service costs as well as long membrane service lives, thanks to integrated cleaning concepts and flushing options
- Service-friendly construction of systems on a corrosion-resistant powder-coated steel or stainless steel frame
- Simple and safe to operate: Central control of the entire system by microprocessor controller or industrial PLC with touch panel and process visualisation
- Application-optimised design taking into account economic aspects, such as the durability of the membranes, energy efficiency and process automation
- One-stop shop: no interface problems, smooth running with short times between definition of the task to joint commissioning and on-site system supervision with our global subsidiaries

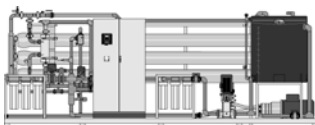

pk_7_074

Technical Details

- Turnkey systems constructed on a high-quality, double powder-coated steel or stainless steel frame
- Highly efficient low-pressure membranes with maximum output and system retention rates of over 99% integrated in epoxy-glass resin pressure pipes
- Pre-filter 5µm with manometer for determining differential pressure
- Pressure switch to protect the high-pressure pump
- Flow meter to display permeate and concentrate volume
- Semi-automatic cleaning system for chemical module cleaning for long module service lives
- Central PLC of the entire system and peripheral components, adapted to customer requirements

Field of application

- Decentralised, public or private supply of potable water.



3 Filtration

The product range Dulcosmose® SW was designed for the following values in feed water:

Salt content max.	40,000 mg/l*
pH range	3.0 ... 10.0
Silt density index max.	3
Free chlorine max.	0.1 mg/l
Total Fe, Mn max.	0.2 mg/l
Total hardness max.	water must be chemically stabilised
Bacteria count max.	100 KBE/ml
Turbidity max.	0.5 NTU
COD max.	5 mg/l**

* Differing salinities affect the performance data accordingly

** As O₂

Plants with 4" and 8" membranes, salt rejection of the plants 99%

Plant	Permeate capacity at 25 °C water temperature l/h	Number of 4" and 8" membranes No.	Connected load without energy recovery kW	Connected load with energy recovery kW	Dimensions H x W x D mm
PRO 0078SW	780	6	5.5		1,800 x 3,500 x 1,000
PRO 0185SW	1,850	3	11.0		1,800 x 4,000 x 1,000
PRO 0240SW	2,400	4	15.0		1,800 x 4,000 x 1,000
PRO 0300SW	3,000	5	18.5	11.2*	1,800 x 4,000 x 1,000
PRO 0360SW	3,600	6	18.5	14.7*	1,800 x 4,000 x 1,000
PRO 0490SW	4,900	8	30.0	20.5*	1,800 x 5,000 x 1,200
PRO 0610SW	6,100	10	37.0	20.5*	1,800 x 6,000 x 1,200
PRO 0730SW	7,300	12	41.0	24.0*	1,800 x 5,000 x 1,400
PRO 0920SW	9,200	15	75.0	27.5*	1,800 x 6,000 x 1,500
PRO 0980SW	9,800	16	75.0	35.5*	1,800 x 5,000 x 1,500
PRO 1230SW	12,300	20	75.0	35.5*	1,800 x 6,000 x 1,500**
PRO 1470SW	14,700	24	90.0	41.0*	1,800 x 7,000 x 1,500**
PRO 1840SW	18,400	30	110.0	56.0*	1,800 x 7,000 x 1,500**
PRO 2210SW	22,100	36	132.0	66.0*	1,800 x 7,000 x 1,500**
PRO 2580SW	25,800	42	150.0	66.0*	1,800 x 7,000 x 1,500**
PRO 2900SW	29,000	48	180.0	90.0*	1,800 x 7,000 x 1,500**

* Energy recovery by pressure exchanger technology

** Separate cleaning tank

On request, these plants can also be supplied with different membrane types for other salt rejection, and with measuring and control equipment (conductivity, ORP, pH measurement) and metering equipment (in pre-treatment and post-treatment).



3 Filtration

3.5 Gravity Filters

3.5.1 Sand Filter INTERFILT® SK

Economical water treatment with gravity filters - using the gravity of the water alone.

Filtration capacity 6.5 – 62.0 m³/h



The gravity filter INTERFILT® SK is an open sand filter system for extremely economical water treatment. The filter system operates with differential pressure-controlled backwashing and an integral backwashing water tank.

The automatic gravity filter uses the principle of differential pressure and essentially consists of the cylindrical tank, its fittings, the automatic backwashing system with injector, the raw water feed and baffle tube, filter nozzles and filter filling unit

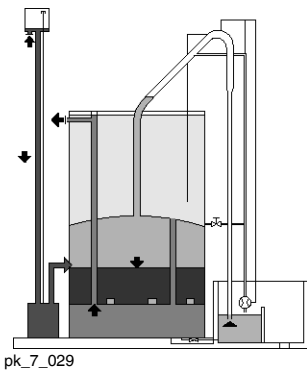

pk_7_029

Your benefits

- No controls: The filter needs no moving parts, like valves, flow meter, controller or display equipment, for filtering/backwashing and post-rinsing
- No pumps: The required volume of backwashing water is stored in the storage tank below the filter, making a back-flushing pump redundant.
- No compressed air, pressurised water and electrical energy: The filter controls and performs all processes independently
- No operating personnel: The filter works fully automatically, without external intervention
- No wearing parts: No moving parts – no wear and tear.

Technical Details

- Material: Polyethylene PE-HD
- Filter material: Filter sand DIN EN 12904, other filter materials on request

The filter essentially consists of:

- Cylindrical tank
- Fittings
- Automatic backwashing system with injector
- Raw water feed and baffle tank
- Filter nozzles and
- Filter filling unit

Field of application

- Cooling water, partial flow filtration
- River water, process water and potable water treatment
- Removal of iron from well water
- Waste water cleaning to reduce the content of suspended matter, CSB, BSB₅ and phosphate (4th cleaning stage)

Optional additional equipment:

- Cover for cylindrical tank
- Frost protection insulation with supplementary electric heating
- Combined air/water backwashing
- PE-HD backwashing water sump tank
- Other options on request



3 Filtration

Type List and Capacity Data

Type	Filter diameter mm	Filter capacity m ³ /h	Back wash Water ~ m ³	Weight empty ~ t	Weight in operation ~ t
SK- 9	900	6.5	1.4	1.2	4.5
SK- 12	1,200	11.5	2.5	1.5	7.1
SK- 15	1,500	18.0	4.5	1.9	10.5
SK- 18	1,800	26.0	5.5	2.3	15.0
SK- 21	2,100	35.0	8.5	2.8	19.5
SK- 24	2,400	46.0	10.0	3.0	25.0
SK- 28	2,800	62.0	14.0	3.5	30.0

Flow rate: 3 ... 10 m/h
 Backwash intervals: Approx. 8 ... 36 h
 (depending on type and amount of pollutants)
 Head loss: 120 ... 150 mbar
 Clean water solids figure: 0 ... 3 mg/l
 (depending on raw water and filter material)
 Backwash flow rate::
 At the start 44 m/h
 In the middle 37 m/h
 At the end 30 m/h
 Cylinder height: 4,500 mm
 (same for all types)
 Overall height: 6,500 mm
 Depending on filter diameter
 Backwash and refilling time: 13 ... 15 min.
 Filter sand in accordance with EN 12904
 – Height of bed 600 mm
 – Grain size range 0.71 ... 1.25 mm
 Filter nozzles:
 – Type Lamellar nozzle
 – Material PPN
 – Slot width 0.2 mm
 As system components are produced individually according to application, we will inform you of prices on request.
 We reserve the right to change components and their construction, as long as these do not affect their performance or function.

3



Product catalogue 2020

Your digital reference source.
Wherever you want. Whenever you want.

Groundbreaking diversity: ProMinent 2020.
Our product catalogue is available in three individual volumes.



Metering Technology



Measuring, Control and Sensor Technology



Water Treatment and Disinfection

You can find our individual catalogue volumes for download or online browsing at
www.prominent.com/en/product-catalogue

Do you need an overview of our entire product range?
Then we would recommend our product overview.
www.prominent.com/en/productoverview