

Operating Instructions

DULCOMETER® DMT

On-site measurement transducer

Measured variables pH/redox/temperature

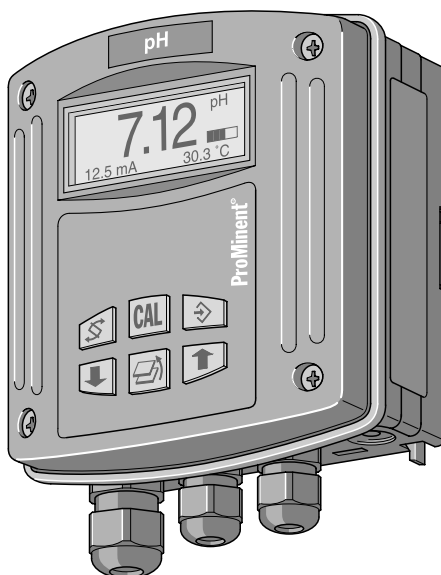

DMTa _____

Please enter the identity code of the device here.

**Please read the operating instructions through completely before
commissioning this equipment! Do not discard!
Any part which has been subject to misuse is excluded from the warranty!**

Publishing details:

Operating Instructions
DULCOMETER® DMT on-site measurement transducer
Measured variables pH/redox/temperature
© ProMinent Dosiertechnik GmbH, 2000

Address:

ProMinent Dosiertechnik GmbH
Im Schuhmachergewann 5-11
69123 Heidelberg · Germany
Telephone: +49 6221 842-0
Fax: +49 6221 842-419
info@prominent.com
www.prominent.com

Subject to technical alterations.

Table of contents

Device identification/identity code: measured variable pH 5

Device identification/identity code: measured variable redox 6

Device identification/identity code: measured variable temperature 7

1 General instructions for use 8

2 Safety 9

 2.1 Correct use 9

 2.2 Safety guidelines 9

3 Storage and transport 9

4 Assembly and installation 10

 4.1 Assembly (mechanical) 10

 4.1.1 Wall mounting 10

 4.1.2 Pipe mounting 11

 4.1.3 Panel mounting 12

 4.2 Installation (electrical) 13

 4.2.1 Wall mounting 14

 4.2.2 Pipe mounting 15

 4.2.3 Panel mounting 15

 4.2.4 Connecting coaxial cable 16

 4.2.5 Connecting terminals 16

5 Device overview and control elements 17

6 Function description 18

 6.1 General 18

 6.2 Key functions 19

 6.3 Operating menu, schematic 19

 6.4 Negotiating operating menu 20

 6.4.1 Calibration menu (pH only) 21

 6.4.2 Info Display 21

 6.4.3 Menu options 21

 6.4.4 Negotiating the menu options 21

7 DMT settings 22

 7.1 Measured variables pH and redox 23

Table of contents

7.1.1	Menu overview: measured variable pH	23
7.1.2	Menu overview: measured variable redox	24
7.1.3	Parameter settings (pH only)	25
7.1.4	Checking the ORP probe (redox only)	25
7.1.5	Parameters: Temperature	26
7.1.6	Parameter output	28
7.1.7	General settings	31
7.2	Measured variable temperature	33
7.2.1	Menu overview measured variable, temperature	33
7.2.2	Parameters temperature	34
7.2.3	Parameter output	34
7.2.4	General settings	36
8	Operating the DMT	38
8.1	Permanent display	38
8.1.1	Probe condition information (pH only)	38
8.1.2	Brightness of LC display	39
8.2	Calibrating the pH meter	39
8.2.1	Automatic buffer detection	39
8.2.2	The calibration process	40
9	Troubleshooting	44
9.1	Error messages during operation	44
9.2	Error messages while calibrating the pH meter	45
10	Maintenance and repair	46
11	Disposal	46
12	Technical data	47
13	Spare parts and accessories	48
	Appendix	49
	Conformity declarationdeclaration	49
	Terminal connection plan pH/redox/temperature	50
	Wiring example - two wire system	51
	PROFIBUS® circuit board terminal connection	52
	Index	53

Device identification/identity code: measured variable pH

DMTa	DULCOMETER® DMT series measurement transducer	
	Mounting type	
W	wall/pipe mounted	
S	control panel mounted (not PROFIBUS®-DMT)	
	Version	
0	with ProMInent logo	
	Electrical connection	
9	4-20 mA (two wire) current loop, 24 V DC (16...40 V DC)	
5	PROFIBUS®-DP, 24 V DC (16...30 V DC)	
	Communication interface	
0	none	
4	PROFIBUS®-DP	
	Measured variable	
P	pH	
R	redox (ORP)	
T	temperature	
	Correction variable	
1	temperature (PT 1000/PT 100)	
	Enclosure rating	
0	standard	
Adjustable general settings:		
	Language	
D	German	
E	English	
F	French	
S	Spanish	
I	Italian	
	Automatic buffer detection	
0	ProMInent buffer set	
D	DIN 19226 buffer set	
V	automatic buffer adjustment	
	Temperature measurement	
0	automatic (PT 1000 or PT 100)	
1	manual	
2	automatic or manual	
9	none	
	Output	
0	measured variable (fault: 23 mA, calibration: 23 mA)	
1	manually adjustable current value	
2	measured variable or manual (fault: 23 mA, calibration: 23 mA)	
3	measured variable or manual (fault: 23 mA, calibration: HOLD)	
4	4 mA constant current	
	Other settings	
0	standard	

Please enter the identity code for your device here.

Device identification/identity code: measured variable redox

DMTa	DULCOMETER® DMT series measurement transducer								
	Mounting type								
W	wall/pipe mounted								
S	control panel mounted (not PROFIBUS®-DMT)								
	Version								
0	with ProMinent logo								
	Electrical connection								
9	4-20 mA (two wire) current loop, 24 V DC (16...40 V DC)								
5	PROFIBUS®-DP, 24 V DC (16...30 V DC)								
	Communication interface								
0	none								
4	PROFIBUS®-DP								
	Measured variable								
R	redox								
P	pH								
T	temperature								
	Correction variable								
1	temperature (PT 1000/PT 100) - measurement only								
	Enclosure rating								
0	standard								
Adjustable general settings:									
	Language								
D	German								
E	English								
F	French								
S	Spanish								
I	Italian								
	Probe type								
0	standard								
	Temperature measurement								
0	automatic (PT 1000 or PT 100)								
9	none								
	Output								
0	measured variable (fault: 23 mA, calibration: 23 mA)								
1	manually adjustable current value								
2	measured variable or manual (fault: 23 mA, calibration: 23 mA)								
3	measured variable or manual (fault: 23 mA, calibration: HOLD)								
4	4 mA constant current								
	Other settings								
0	standard								
<table border="1" style="width: 100%; text-align: center;"> <tr> <td>DMTa</td> <td>0</td> <td>R</td> <td>1</td> <td>0</td> <td>0</td> <td>0</td> </tr> </table>			DMTa	0	R	1	0	0	0
DMTa	0	R	1	0	0	0			

Please enter the identity code for your device here.

Device identification/identity code: measured variable temperature

DMTa	DULCOMETER® DMT series measurement transducer	
	Mounting type	
W	wall/pipe mounted	
S	control panel mounted (not PROFIBUS®-DMT)	
	Version	
0	with ProMInent logo	
	Electrical connection	
9	4-20 mA (two wire) current loop, 24 V DC (16...40 V DC)	
5	PROFIBUS®-DP, 24 V DC (16...30 V DC)	
	Communication interface	
0	none	
4	PROFIBUS®-DP	
	Measured variable	
P	pH	
R	redox (ORP)	
T	temperature	
	Correction variable	
0	none	
	Enclosure rating	
0	standard	
Adjustable general settings:		
	Language	
D	German	
E	English	
F	French	
S	Spanish	
I	Italian	
	Probe type	
0	PT 100 or PT 1000	
	Temperature detection	
0	Probe (PT 1000 or PT 100)	
	Output current	
0	Output: measured variable (fault: 23 mA, calibration: 23 mA)	
1	Output adjustable	
2	measured variable or adjustable (fault: 23 mA, calibration: 23 mA)	
3	measured variable + manual + HOLD (fault: 23 mA, calibration: HOLD)	
4	Output current = 4 mA	
	Other settings	
0	standard	

DMTa	0	T	0	0	0	0	0	0
-------------	----------	----------	----------	----------	----------	----------	----------	----------

Please enter the identity code for your device here.

1 General instructions for use

Please read through these instructions for use carefully. They will enable you to make the best possible use of this operating instructions manual.

The following sections are highlighted in the text:

- Enumerated points
- ▶ Instructions

Working instructions

NOTE

Guidelines are intended to make your work easier.

and safety instructions:



CAUTION

***Describes a potentially dangerous situation.
Non-observance can lead to personal injury or damage to property.***



IMPORTANT

***Describes a potentially dangerous situation.
Non-observance can lead to damage to property.***

2 Safety

2.1 Correct use

The DMT on-site measurement transducer is designed exclusively for the

- measurement of pH value resp. redox potential
- measurement of temperature
- display of measured variables
- production of an output signal

It is prohibited to use the device for any other applications or to modify it in any way!

The device must not be used outdoors without added protection (housing, weatherproof cover).

2.2 Safety guidelines



CAUTION

- *The device must not be used in a possible explosion area.*
- *The DMT must be operated by trained and authorised personnel.*



IMPORTANT

- *The system must be suitably equipped and configured to prevent overdosing of hazardous materials due to probe failure.*
- *The DMT has no on/off switch. It starts to function as soon as it is connected to a power supply.*

3 Storage and transport

Store and transport the DMT in the original packaging.



IMPORTANT

- *Protect the DMT from damp and the effects of chemicals even when packed.*

Ambient conditions for storage and transport:

Temperature:	-20 °C to 70 °C
Humidity:	max. 95 % relative humidity, non condensing

4 Assembly and installation



IMPORTANT

- **The DMT is fully resistant to normal environments control rooms.**
- **The DMT must not be placed where it can come into contact with rain or direct sunlight!**
Use a protective housing or weatherproof cover if in use out of doors.

4.1 Assembly (mechanical)

The DMT can be wall, pipe or panel mounted (not for PROFIBUS®-DMT).

4.1.1 Wall mounting

Mounting materials (included in delivery):

- 1 x wall/pipe bracket
- 2 x 5x45 mm round headed screws
- 2 x 5.3 washers
- 2 x wall plugs Ø 8 mm, plastic
- 1 x rubber insert
- 1 x locking screw (PT)

Wall mounting, please follow the steps below:

- ▶ Remove wall/pipe bracket from DMT:
pull the two snap fasteners outwards and push upwards (fig. 1, ①).
Swing the wall/pipe bracket away from the DMT and pull downwards (fig. 1, ②).
- ▶ Mark two drill holes diagonally opposite one another using the mounting bracket as a template.
- ▶ Drill the holes: Ø 8 mm, depth = 50 mm.
- ▶ Screw the wall/pipe bracket in place inserting the washers (fig. 2).
- ▶ If the DMT is also to be secured with a screw, pierce the screw hole in the back of the housing (housing must be open) and attach a rubber insert (fig. 2, ①) to the bracket.
- ▶ Hang the DMT onto the top of the bracket (fig. 3, ①) and push down gently against the bracket (fig. 3, ②), then push upwards until you hear a click (fig. 3, ③).
- ▶ Tighten the locking screw to secure more firmly (housing is open).

Fig. 1

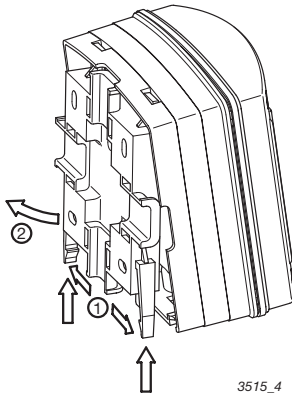

Fig. 2

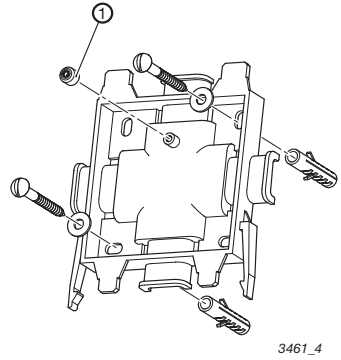
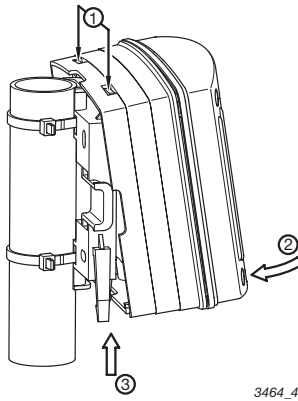

Fig. 3



4.1.2 Pipe mounting

Mounting materials (included in delivery):

- 1 x wall/pipe bracket
- 2 x cable ties
- 1 x sealing cap
- 1 x locking screw (PT)

Can be mounted onto pipes of diameters from 25 mm to 60 mm.

Pipe mounting, please follow the steps below:

- ▶ Remove wall/pipe bracket from DMT:
pull the two snap fasteners outwards and push upwards (fig. 1, ①).
Swing the wall/pipe bracket away from the DMT and pull downwards (fig. 1, ②).
- ▶ Fasten the bracket to the pipe using the cable ties or pipe clamps (fig. 3).
- ▶ If the DMT is also to be secured with a screw, pierce the screw hole in the back of the housing (housing must be open) and attach a rubber insert (fig. 2, ①) to the bracket.
- ▶ Hang the DMT onto the top of the bracket (fig. 3, ①) and push down gently against the bracket (fig. 3, ②), then push upwards until you hear a click (fig. 3, ③).
- ▶ Tighten the locking screw to secure more firmly (housing is open).

4.1.3 Panel mounting



IMPORTANT

- ***The control panel must be thick enough to withstand the weight of the mounted DMT without buckling. (To achieve enclosure rating IP 54, steel must be at least 2 mm thick; plastic should be correspondingly thicker).***

NOTE

The DMT will protrude from the control panel approx. 30 mm once mounted.

Fig. 4

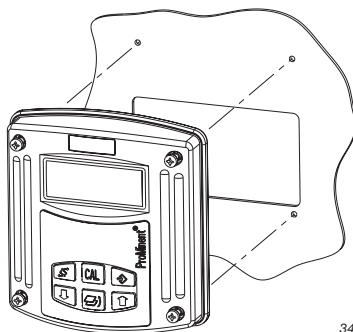

3463_4

Panel mounting, please follow the steps below:

- ▶ Decide on the exact position of the DMT on the panel using the drill template.
- ▶ Centre punch the holes for the screws and cut-out through the drilling template.
- ▶ Drill the four screw holes with a \varnothing 3.5 mm diameter drill bit.
- ▶ Punch out the cut-out or drill the four inner holes using an \varnothing 8 mm diameter drill bit and pierce out the cut-out with a keyhole saw.



CAUTION

Sharp edges can cause injury.

- ▶ File off cut edges.
- ▶ Insert the profile seal into the groove provided on the DMT.
- ▶ Place the DMT onto the cut-out and screw in place.



IMPORTANT

***Check that the seal is located correctly.
IP 54 is only achieved when assembly has been carried out correctly.***

4.2 Installation (electrical)



IMPORTANT

- ***Installation must be carried out by specially trained personnel.***
- ***Installation can only be carried out after assembly has been completed.***
- ***The device must be connected to a protective low voltage in accordance with EN 60335-1.***
- ***Observe the relevant technical data in chapter 12 throughout installation procedures.***
- ***The current loop must be disconnected from the power supply during installation.***
- ***The DMT signal cable must not be laid next to leads subject to high levels of interference. Can lead to malfunction of DMT.***
- ***The hinge between the front and back sections of the housing is not particularly strong. When working on the front section it should be held securely in place.***

4.2.1 Wall mounting

- ▶ Unfasten the four housing screws
- ▶ Lift the front section slightly forwards and then swing open to the left.
- ▶ Pierce threaded cable apertures at the bottom of the rear side as required (fig. 5).

Fig. 5

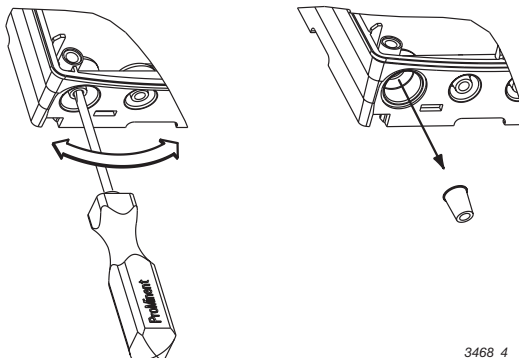

NOTE

- **The large gland (M 20 x 1.5) is intended for the sensor cable.**
 - **Feed the power cable leftwards through the smaller threaded connector (M 16 x 1.5). Follow with the other sensor cables (e.g. PT 1000).**
- ▶ Tighten the threaded connectors (fig. 6, ①) as required.
 - ▶ Use reducers as required (fig. 6, ②) to adapt the sizes of the threaded connectors to the actual cable diameters.
 - ▶ Feed the cables into the threaded connectors.
 - ▶ Now proceed according to 4.2.4 Connecting coaxial cable and 4.2.5 Connecting terminals.
- Then** follow the steps below:
- ▶ Tighten the locking screws (fig. 6, ③) for the threaded connectors.
 - ▶ Swing the front section onto the back section.



IMPORTANT

Check that the seal is located correctly. IP 65 is achieved only when assembly has been carried out correctly.

(If necessary pull the front section forward in order to reduce the stress on the seal.)

- ▶ Tighten the housing screws finger tight.

Fig. 6

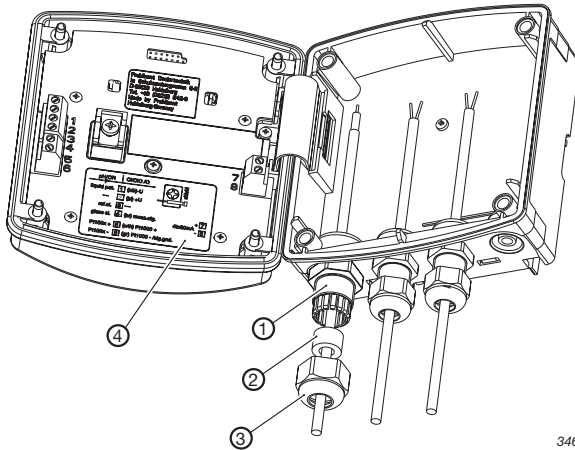

3465_3

4.2.2 Pipe mounting

See 4.2.1 Wall mounting

4.2.3 Panel mounting

NOTE

The cable must be laid in cable ducting on site to minimise stresses.

Connect the cable from the back through the cut-out in the control panel:

- ▶ Follow the steps given in 4.2.4 Connecting coaxial cable and 4.2.5 Connecting terminals.

4.2.4 Connecting coaxial cable

The pH resp. redox probe is connected via a coaxial cable:

- ▶ Strip back to reveal cable shield (reference electrode) in accordance with fig. 7 (left) and clamp using the shield clip.

The shield clip is connected internally to terminal 3.

Under normal circumstances measuring can be carried out without connecting a liquid reference potential. In this case provide wire jumpers between terminals 1 and 2.

When electrical conditions are more complex a potential plug should be connected to terminal 1. Terminal 2 is left free.

The appendix contains an overview of connection options (terminal connection plan).

4.2.5 Connecting terminals

- ▶ Remove insulation from cable ends as shown in fig. 7 (right) and attach end crimps to each core.
- ▶ Connect the cables in accordance with the terminal connection plan.



IMPORTANT

- **Do not operate PROFIBUS® variants at voltages over 30 V.**
- **Connect PROFIBUS® variant power supplies via terminals 3 and 4 on the PROFIBUS® circuit board in the back section, not terminals 7 and 8 in the front section.**

NOTE

- **The terminal connection plan is given in the appendix. There is also a panel giving connection information affixed to the housing near the terminals (fig. 6, ④ and fig. 8).**
- **Push the cable through the housing until the front section can be moved up and down easily.**
- **If the LC display is too weak, reduce the brightness using the up arrow key \uparrow . If the display is too dark, increase the brightness using the down arrow key \downarrow .**

Fig. 7

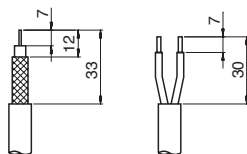

3459_4

Fig. 8

pH/ORP	Cl/ClO ₂ /O ₂	
liquid pot.	[1] (blk)-U	
---	[2] (bl) +U	
ref. el.	[3] ---	
glass el.	[4] (br) meas.sig.	+ [7]
Pt100	+ [5] (wth) Pt1000 +	4to20mA - [8]
Pt100	- [6] (gr) Pt1000 - /sig.gnd.	

5 Device overview and control elements

Fig. 9

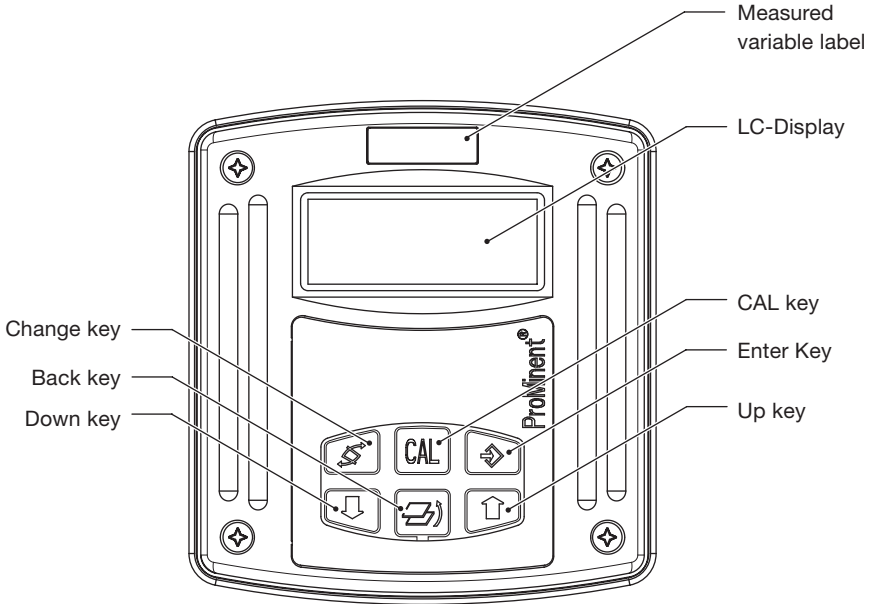

3456_4

6 Function description

6.1 General

The DULCOMETER® MEASUREMENT TRANSDUCER (DMT) is a micro-processor controlled on site measurement transducer. It displays the selected measured variable and produces a proportional output signal. It can also use temperature as a correction variable. The user can specify these functions using the operating menu.

The user can switch between the measured variables pH value, redox potential and temperature.

The inputs are collectively electrically insulated against the output.

In the event of a fault the DMT indicates an error message on the LC display and produces an increased current (23 mA) through the ring circuit.

The DMT is also available for the following measured variables:





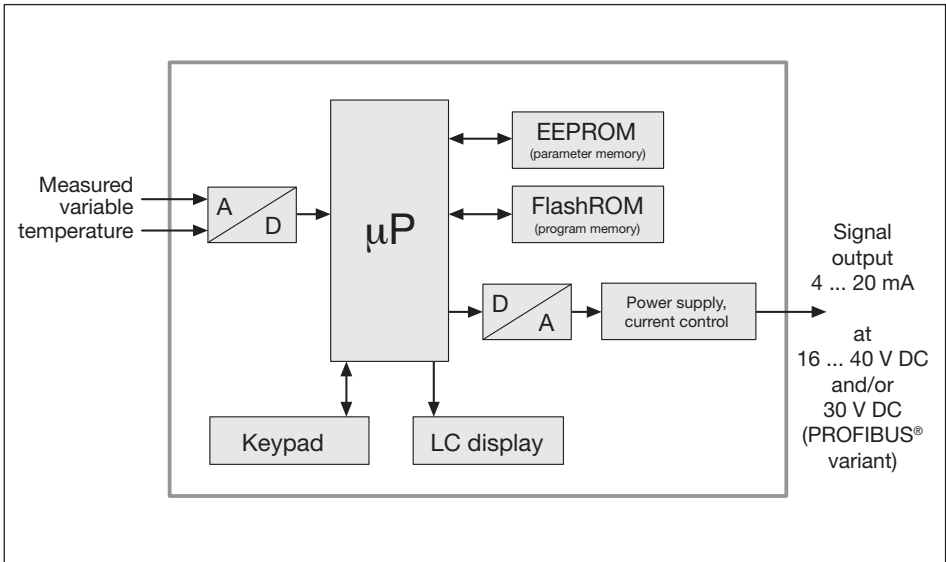

- Conductivity
- Chlorine

Block circuit diagram



6.2 Key functions

The key are used to alter the DMT settings and have the following functions:

	In the permanent display / in the info display	In the menu options
Change key 	Toggles between permanent display and info display modes	Scrolls through values of the current menu option
Back key 	Exits info display mode and returns to permanent display mode	Exits to info display without saving changes to values
Enter key 	Accesses menu option (from an info display)	Saves changes to values in current menu option and accesses the next info display or another menu option
CAL key 	Opens the calibration menu (from permanent display)	Activates calibration in calibration menu (pH only)
Down key  Up key 	Alters brightness of the LC display (in permanent display mode)	Changes a value

6.3 Operating menu, schematic

The operating menu comprises:

- **the permanent display**
- **the calibration menu**
- **the info displays** (info level)
for the display of pre-set parameters resp. general settings
- **menu options** (settings level)
for altering parameters resp. general settings

Function description

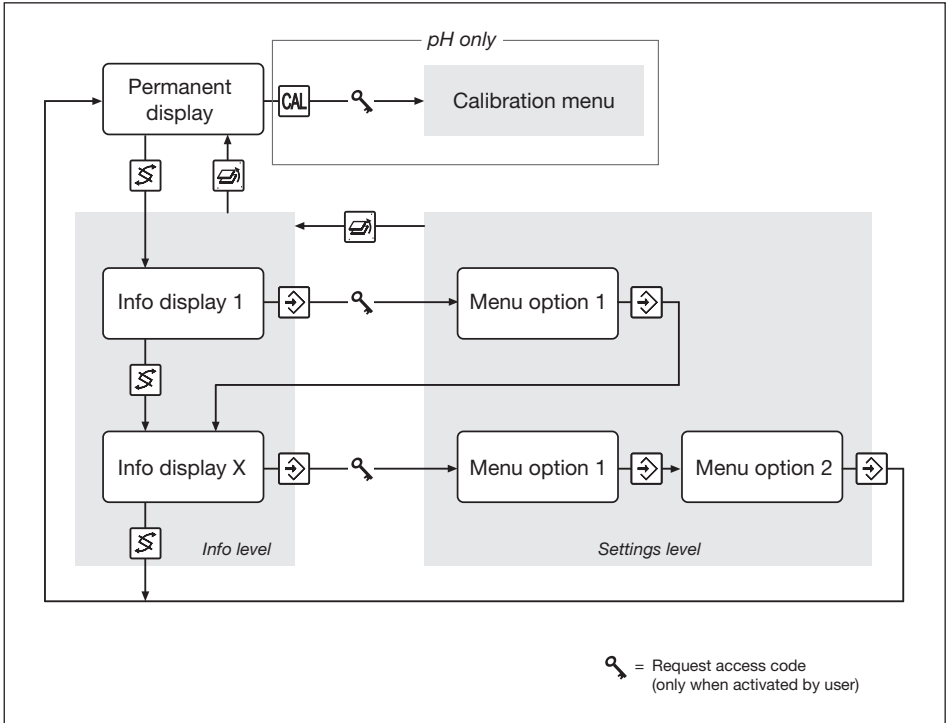

6.4 Negotiating operating menu

NOTE

- **The back key** **can be used to exit the operating menu at any time. Depending upon where you are in the operating menu, you will return either to the permanent display or to the corresponding info level.**
- **The display will automatically return to permanent display if you do not press a key within 5 min. (does not save changes to values).**
- **If an access code has been activated by the user, access code protection is applied to both the calibration menu and the settings level menu options. To access these menu options the access code must be entered when it is requested and confirmed with the enter key** **. Access restriction is reinstated each time you return to the permanent display.**
- **The access code is factory set to 5000 (inactive).**

6.4.1 Calibration menu (pH only)

Access the calibration menu from the permanent menu using the CAL key  (further details given in 8.2 Calibrating the pH meter)

6.4.2 Info Display

Access the first info display of the info level from the permanent display using the change key .



Use the change key  to access the other info displays in turn. Returns to the permanent display after the last info display.

6.4.3 Menu options

Use the enter key  to access the menu options associated with that info level.

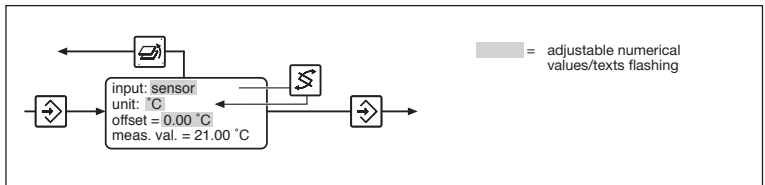
6.4.4 Negotiating the menu options



Press the change key  to activate all adjustable values in a menu option. Flashing values can be altered. Use the arrow keys  /  to alter numerical values or texts.

Keystrokes perform the following actions:

- 1 x short keystroke reduces/increases a numerical value by one increment or alters a text
- Holding the key down for longer alters numerical values increasingly rapidly.

Use the enter key  to save changed values in the menu option. You will then automatically enter the next info display or (if available) the next menu option.

NOTE

Your entries become active immediately and are stored permanently when you press the enter key .

If you do not wish to save changes, exit the menu option using the back key . You will then return to the info display for that menu.

7 DMT settings

NOTE

- **Settings need only be changed if your process requirements differ from factory general settings.**
- **If your DMT does not display the required settings option, check the general settings of your device as described in chapter 7.1.7.**

Menu overview table

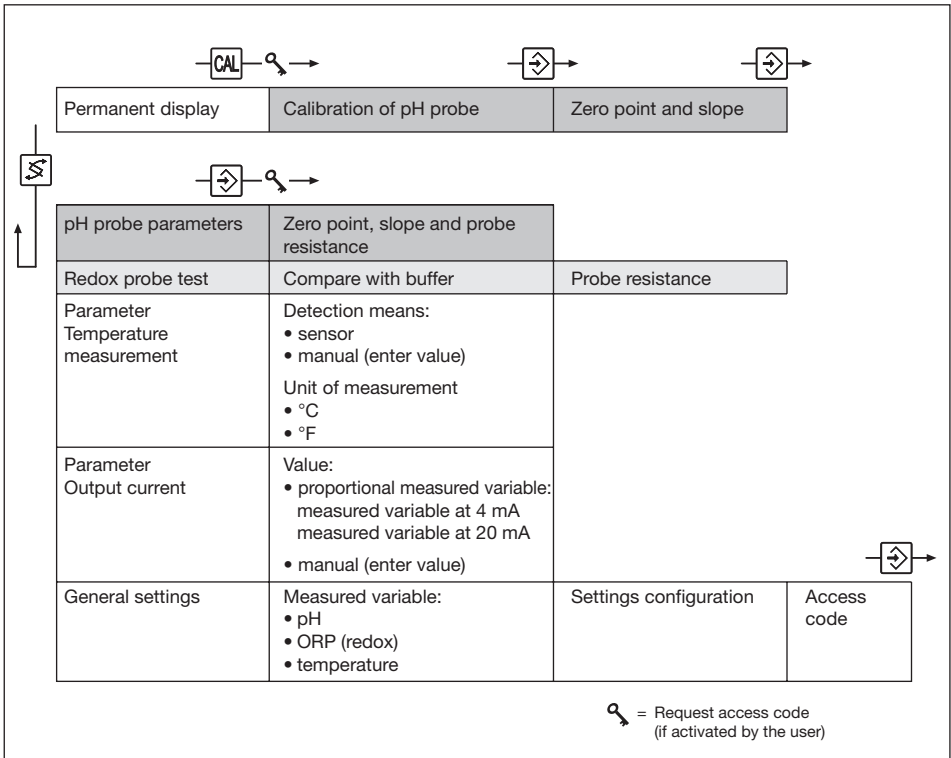

7.1 Measured variables pH and redox

7.1.1 Menu overview: measured variable pH

NOTE

The following menu is only an example.

The displays can vary depending upon the general settings.

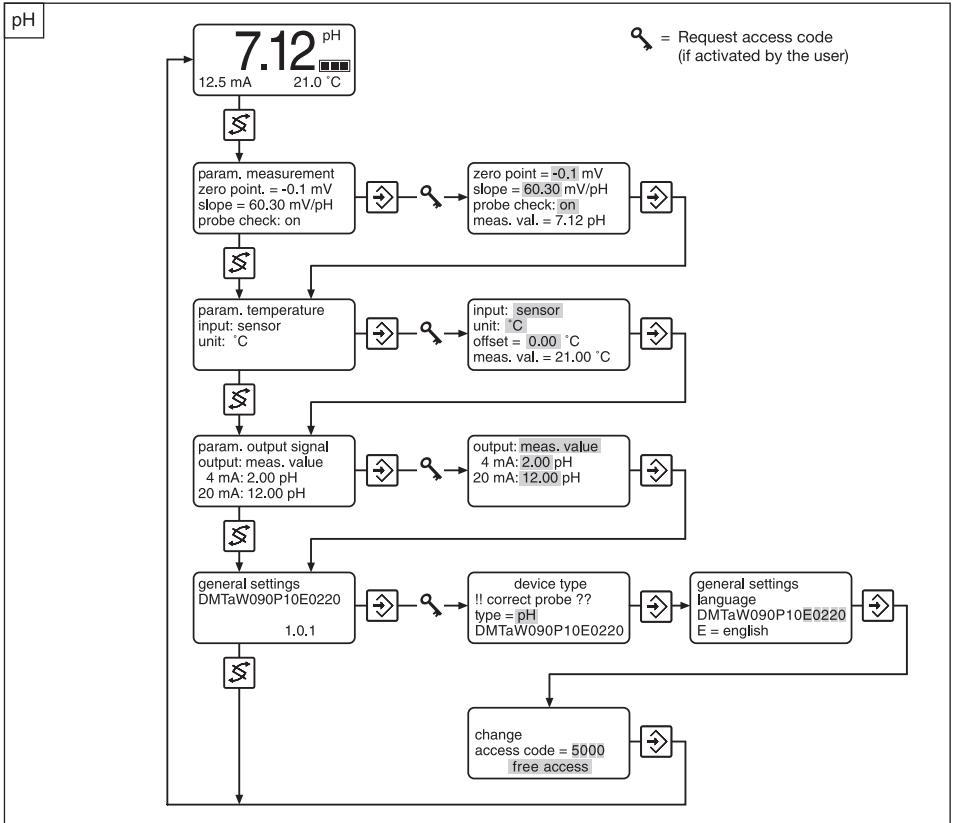

7.1.2 Menu overview: measured variable redox

NOTE

The following menu is only an example.

The displays can vary depending upon the general settings.

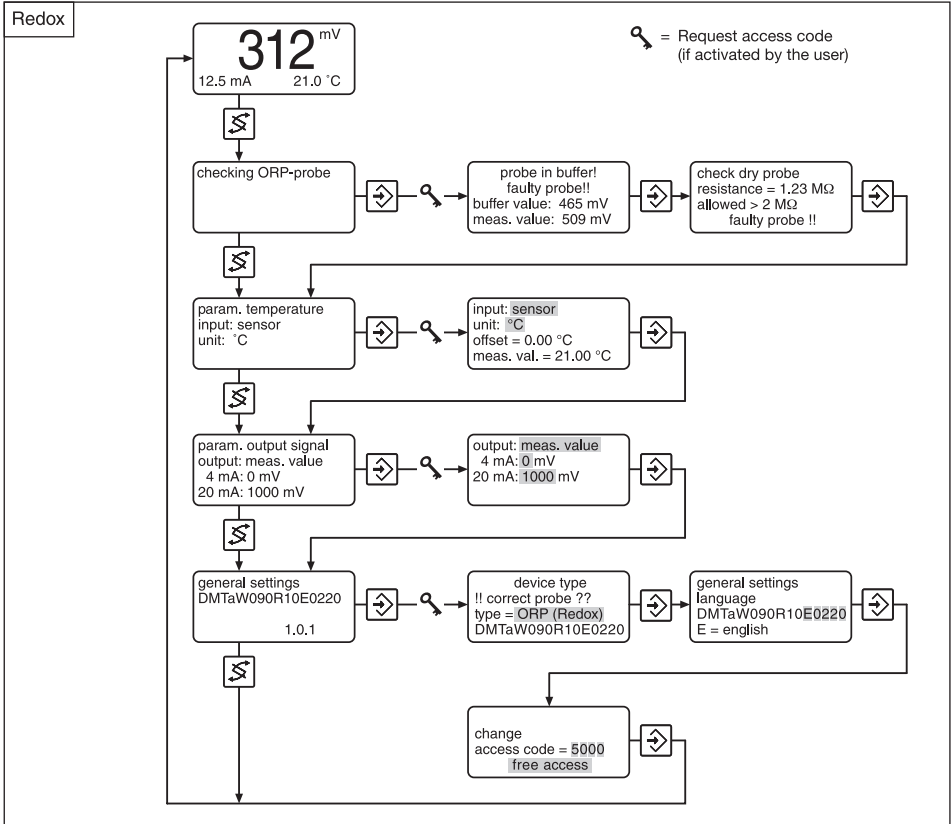

7.1.3 Parameter settings (pH only)

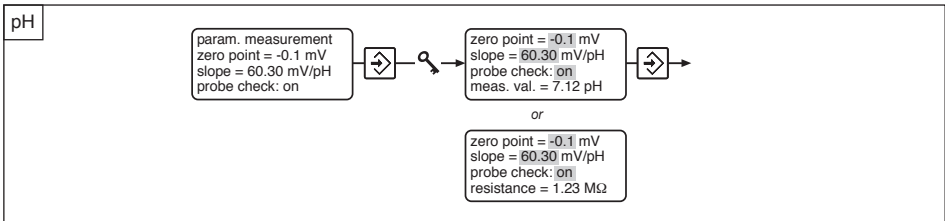

The following settings options are available to you:

Zero point and slope

- ▶ Enter the calibration values of the pH probe under “zero point” and “slope” if these have been obtained by other means than via the DMT calibration menu.
The current pH value is displayed under “meas. value” for monitoring purposes.

Probe check

- ▶ Select **on** or **off** under “probe check” to activate/deactivate the pH probe check.

If the probe check is active (**on** flashes) the resistance value of the pH probe is displayed under “resistance”.

If the resistance value falls below 2 MΩ at any time during operation for longer than 1 minute the error message “defective pH probe !!” appears in the permanent display. Alternatively, if it is above 200 MΩ and the measurement signal is fluctuating significantly, the error message “pH input error!” is activated along with the display value “-2.00 pH” or “16.00 pH”.

NOTE

Sample liquid temperatures below 20 °C or above 60 °C can cause incorrect signals during probe monitoring. In this case we recommend that you switch off the probe check as long as the pH probe is functioning correctly.

7.1.4 Checking the ORP probe (redox only)

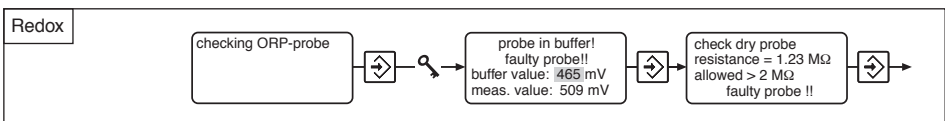

NOTE

The output current value is frozen during probe testing at, depending upon the general settings, the last measured value (HOLD) or at 23 mA (see chapter 7.1.7 General settings).

DMT settings

Two different test options are available:

Comparison with buffer

You can check the probe in the first menu option by measuring the redox potential of a buffer solution:

The suggested “buffer value” (the redox potential for the buffer solution) is 220 mV or 465 mV. This value can be changed. The device compares the buffer value with the measured variable and displays an error message “faulty probe !!” if the difference is greater than 40 mV.

Probe resistance

The probe can be checked in the second menu option by measuring the electrical resistance between the electrodes of the probe (must be dry):

It is particularly important that there is no residual moisture adhering to the probe.

If the resistance measured is less than 2 MΩ the device will display the error message “faulty probe !!”.

7.1.5 Parameters: Temperature

NOTE

- **The DMT automatically detects whether a PT 1000 or PT 100 is connected.**
- **If there is no temperature gauge connected the temperature measurement should be set to “none” or “manual” (see chapter 7.1.7 General settings).**

Depending upon the “temp. meas.” general setting you have the following options:

7.1.5.1 General setting: Temperature measurement = automatic

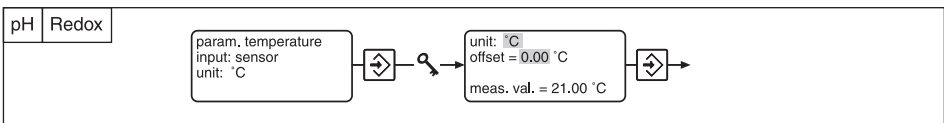

- ▶ Select the unit of measurement for temperature °C or °F under “unit”.
- ▶ Enter the difference Δt under “offset” to a reference temperature measurement (see chapter 7.5.5 Calibrating the Pt 100 temperature gauge).

The actual temperature measured is displayed under “meas. val.”.

7.1.5.2 General setting: Temperature measurement = manual (pH only)

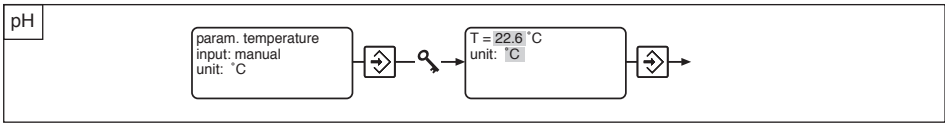

- ▶ Enter the process temperature under “T”.
- ▶ Select the temperature unit °C or °F under “unit”.

7.1.5.3 General setting: Temperature measurement = automatic or manual (pH only)

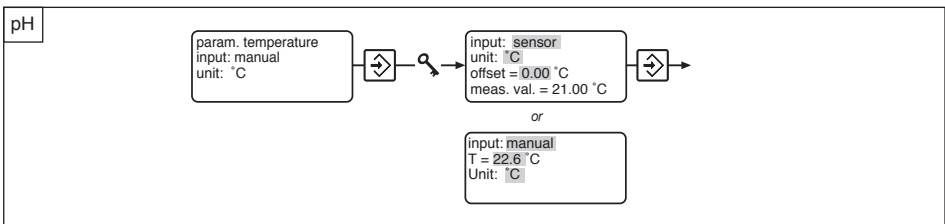

- ▶ Under “input” select **sensor** or **manual**:
 Select **sensor** if a temperature gauge is connected (temperature measurement = automatic):
 Select **manual** if the user is going to enter the process temperature (temperature measurement = manual).

The selection made under “input” affects subsequent settings options.

Sensor If you have selected **sensor** in the “input” option:

- ▶ Select the unit of measurement for temperature °C or °F under “unit”.
- ▶ Enter the difference Δt under “offset” to a reference temperature measurement (see 7.1.5.5 Calibrating the Pt 100 temperature gauge).

The actual temperature measured is displayed under “meas. val.”.

Manual If you have selected **manual** in the “input” option:

- ▶ Enter the process temperature under “T”.
- ▶ Select the temperature unit °C or °F under “unit”.

7.1.5.4 General setting: Temperature measurement = none

No info display appears in the operating menu.

No temperature measurement is carried out.

7.1.5.5 Calibrating the PT 100 temperature gauge

NOTE

You need only calibrate the temperature gauge if

- *You have a PT 100 temperature gauge and the sensor cable is longer than 4 m.*
 - *You have a precision measurement device (the DMT measures to $\pm 0.5\text{ }^{\circ}\text{C}$ / $\pm 0.9\text{ }^{\circ}\text{F}$ accuracy).*
 - *Do not replace the temperature sensor during calibration!*
- ▶ Immerse the DMT temperature gauge and the reference measurement device into the same liquid sample.
 - ▶ Read off the value from the reference measurement device once the temperature is stable.
 - ▶ Set the correction value under “offset” until the temperature value is identical to the reference value.

7.1.6 Parameter output

Depending upon the “output” general setting you have the following settings options:

7.1.6.1 General setting: output current = measured value (= 0 in identity code)

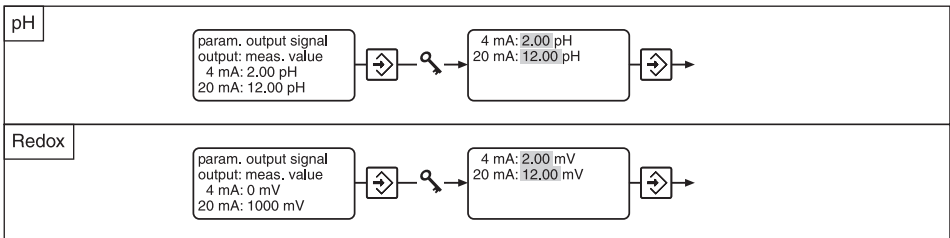

- ▶ Under “4 mA” enter the value at which the output current should be 4 mA.
- ▶ Under “20 mA” enter the value at which the output current should be 20 mA.

During calibration or checking of the ORP probe, the output current increases to 23 mA.

7.1.6.2 General setting: output current = adjustable (= 1 in identity code)

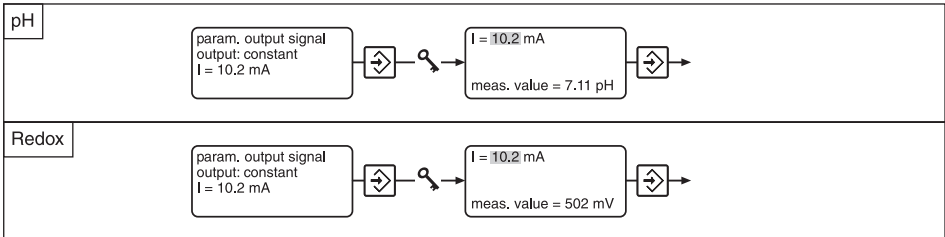

This setting serves as a function check.

- ▶ Enter under “I” any output current between 4 and 20 mA.

The current pH value or the current ORP are displayed in “meas. val.” for verification purposes.

7.1.6.3 General setting: output current = measured value or adjustable (= 2 in identity code)

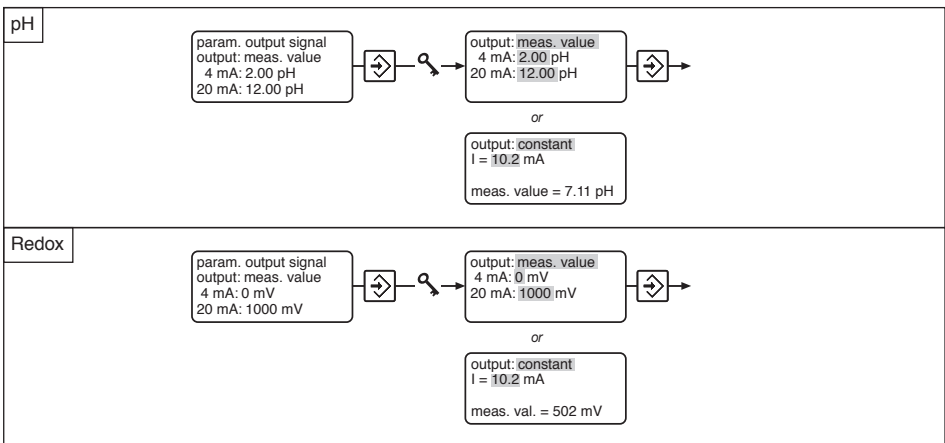

- ▶ Under “output” select **meas. value** or **constant**:
Select **meas. value** if you require the output current to be proportional to the measured value (output = meas. val.);
Select **constant** if you are going to enter the output current manually (output = manual).

The “output” selection affects subsequent settings options:

Measured variable

If you have selected **meas. value** under “output”:

- ▶ Under “4 mA” enter the value at which the output current should be 4 mA.
- ▶ Under “20 mA” enter the value at which the Output current should be 20 mA.

- Constant* If you have selected **constant** under “output”
- ▶ Enter under “I” any output current between 4 and 20 mA.
- The current pH/redox value is displayed under “meas. value” for monitoring purposes.
- This setting serves as a function check. During calibration or checking of the ORP probe, the output current increases to 23 mA.

7.1.6.4 General setting: output current = measured value + adjustable + HOLD (= 3 in identity code)

In this general setting, the DMT can be adjusted as shown in 7.1.6.1 or 7.1.6.3. The following differences should be noted:

pH

For DMT pH, the output current remains at the output current value last reported (HOLD function) during calibration. The output current freezes the moment the menu option “input” is exited using the CAL key. This output current corresponds to the last measured pH value. The HOLD value of the output current is held until the calibration is completed. It is also possible to set a certain HOLD value in the first measuring point of the calibration menu (see 8.2.2).

Redox

With regard to DMT redox, the output current increases during calibration of the ORP probe to the output current value last displayed (HOLD function) upon activation of the ENTER key. This output current corresponds to the last measured redox value. The HOLD value of the output current is held until the menu “checking of redox probe” is exited.

7.1.6.5 General setting: output = 4 mA (= 4 in identity code)

No info display appears in the operating menu.

The DMT emits a constant output current of 4 mA.

This setting serves as a function check and is selected if the DMT is to be used purely as a display device (current consumption is minimal in this case!).

7.1.7 General settings

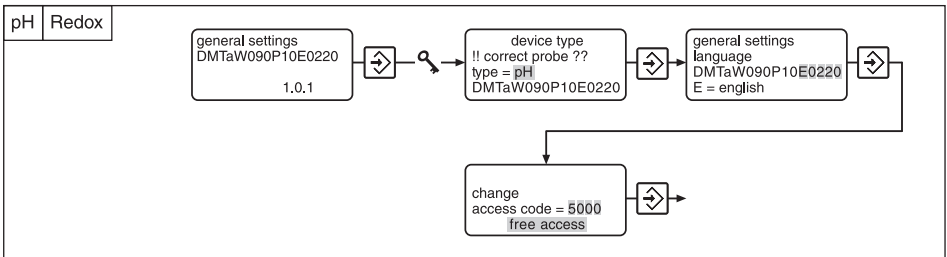

7.1.7.1 Changing the device type

You can select the measured variables, pH or redox potential, in the first menu option “device type”.

► Under “type” select **pH** or **ORP (redox)**.

Depending upon your choice the corresponding identity code position alters: pH = “P”, redox = “R”.

If you have confirmed the change of measured variable with the enter key  the output current will change immediately.

The settings for each measured variable are unaffected even after a different selection has been made and are reinstated if the selection is reversed.

7.1.7.2 Changing general settings

You can adapt the DMT to your individual process requirements in the second menu option “general settings”.

Access the individual identity code positions using the change key .

Non-alterable features are automatically bypassed.

The following tables show the settings options depending upon the selected measured value (the sequence from left to right corresponds to the identity code position).

Measured variable pH				
Language	Automatic buffer detection	Temperature measurement	Output	Other settings
D = German E = English F = French S = Spanish	0 = ProMinent buffer set D = DIN 19266 buffer set V = automatic adjustment	0 = automatic 1 = manual 2 = automatic or manual 9 = none	0 = measured variable; fault 23 mA, at calibration 23 mA 1 = manually adjustable current value 2 = measured variable or manual: at fault 23 mA, at calibration 23 mA 3 = measured variable or manual: at fault 23 mA, when calibrating the last measured value (HOLD) 4 = constant 4 mA current	0 = standard

DMT settings

Measured variable redox				
Language	Probe type	Temperature measurement	Output	Other settings
D = German E = English F = French S = Spanish	0 = standard	0 = automatic 9 = none	0 = measured variable: at fault 23 mA, at calibration 23 mA 1 = manually adjustable current value 2 = measured variable or manual: at fault 23 mA, at calibration 23 mA 3 = measured variable or manual: at fault 23 mA, when calibrating the last measured value (HOLD) 4 = constant 4 mA current	0 = standard

7.1.7.3 Changing access code

The factory pre-set access code is **5000**. This setting allows unlimited access to the calibration menu and the menu options in the settings level.

This code can be changed in the third menu option “change access code”. Use the change key  to move to individual digits.

The new code is confirmed and activated with the enter key .

NOTE

- ***If an access code has been activated, both the calibration menu and the menu options are access-protected. To gain access, enter the access code when requested to do so and confirm using the enter key . Access protection is reactivated when the DMT returns to continuous display mode.***
- ***Deactivate the access code by resetting the code to 5000 in the “change access code” menu option.***

7.2 Measured variable temperature

7.2.1 Menu overview measured variable, temperature

NOTE

The following menu is only an example.

The displays can vary depending upon the general settings.

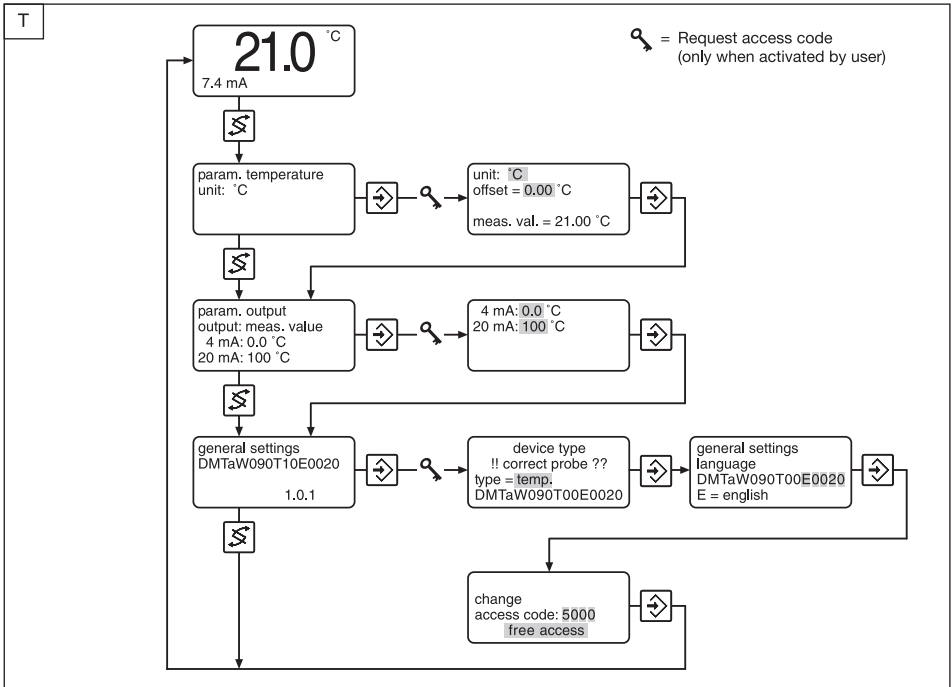

7.2.2 Parameters temperature

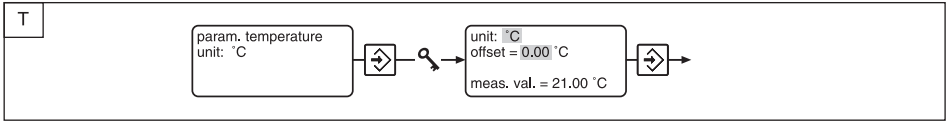

- ▶ Select the temperature unit **°C** or **°F** under “unit”.
- ▶ Enter under “offset” the difference Δt from a reference temperature measurement (see 7.1.5.5 Calibrating the Pt 100 temperature gauge).
The actual measured temperature is displayed under “meas. val.”.

NOTE

- *The DMT automatically recognises whether a PT 1000 or a PT 100 has been connected.*

7.2.3 Parameter output

You have the following settings options, depending on the “output” type you selected under general settings:

7.2.3.1 General setting: output current = measured variable (= 0 in the identity code)



- ▶ Under “4 mA”, enter the value at which the output current should be 4 mA.
- ▶ Under “20 mA”, enter the value at which the output current should be 20 mA.

7.2.3.2 General setting: output current = adjustable (= 1 in the identity code)

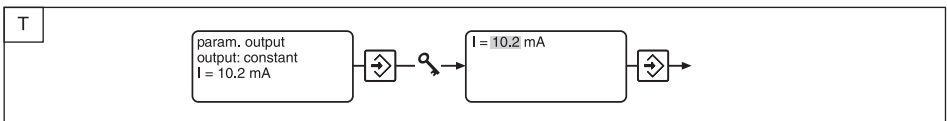

- ▶ Under “I”, enter an output current between 4 and 20 mA.

This setting is used for the function check.

7.2.3.3 General setting: output current = measured value or adjustable (= 2 in the identity code)

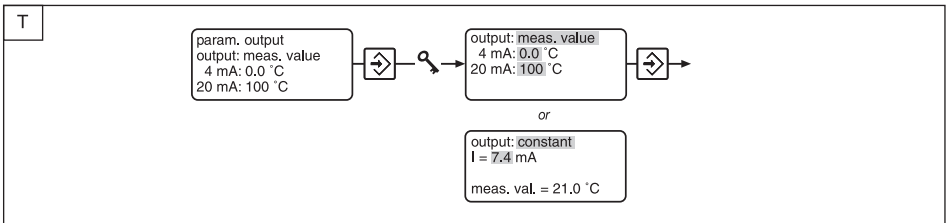

- ▶ Under “output”, select **meas. value** or **constant**:
Select **meas. value** if the output current should be proportional to the measured value (output = measured value):
Select **constant** if the output current is to be entered manually (output = adjustable).

The selection you make under “output” influences the subsequent settings options:

If you selected “output” **meas. value**:

- ▶ Under “4 mA”, enter the value at which the output current should be 4 mA.
- ▶ Under “20 mA”, enter the value at which the output current should be 20 mA.

Entry If you selected “output” **constant**:

- ▶ Under “I”, enter any output current between 4 and 20 mA.

7.2.3.4 General setting: output = 4 mA (= 4 in the identity code)

No information display will appear in the operating menu.

The DMT emits a constant output current of 4 mA.

This setting is used for the function check and/or is selected if the DMT is to be used purely as a display device (the power consumption is minimal in this case).

7.2.4 General settings

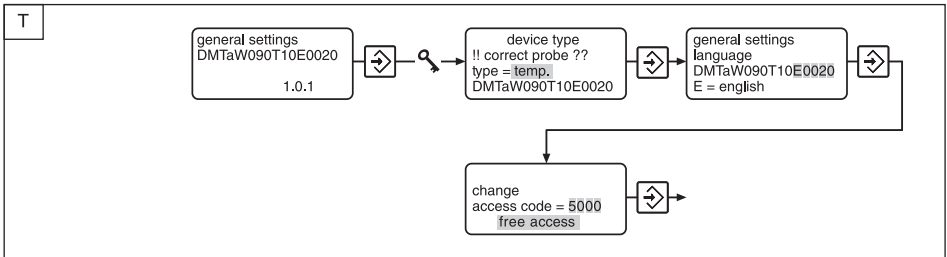

7.2.4.1 Changing device type

The first menu option, “device type”, is used to switch between the measured variables pH value, redox voltage or temperature:

► Under “type”, select **pH**, **ORP (redox)** or **Temperature**.

The corresponding identity code position changes depending on your choice: pH= “P”, redox = “R”, temperature = “T”.

If you confirm the change of measured variable using the enter key , the output current changes immediately.

The settings for each measured variable are unaffected by switching from one to another, i.e. you do not need to re-set them when re-selecting a measured variable.

7.2.4.2 Changing general settings

The second menu option; “general settings”, is used to adapt the DMT to your specific process requirements.



Scroll through individual identity code positions using the “Change” key  until you reach the one you require. Non-adjustable features are automatically bypassed.

The following tables show the settings options for each measured variable (the sequence from left to right corresponds to the identity code positions).

Measured variable temperature				
Language	Probe type	Temperature input	Output current	Additional settings
D = German E = English F = French S = Spanish	0 = PT 100 or PT 1000	0 = sensor	0 = measured variable; at fault 23 mA at calibration 23 mA 1 = adjustable output 2 = measured variable or adjustable; at fault 23 mA at calibration 23 mA	0 = standard

7.2.4.3 Change access code

The factory-set default access code is **5000**. This setting allows unlimited access to the calibration menu and the settings level menu options.

This code can be changed in the third menu option; “change access code”. Use the change key  to bring up the individual digits and confirm using the enter key. Once all digits have been selected you can activate the code by pressing the enter key  once more.

NOTE

- *If an access code has been activated, both the calibration menu and the menu options are access-protected. To gain access, enter the access code when requested to do so and confirm using the enter key . Access protection is reactivated when the DMT returns to continuous display mode.*
- *Deactivate the access code by resetting the code to 5000 in the “change access code” menu option.*

8 Operating the DMT

8.1 Permanent display

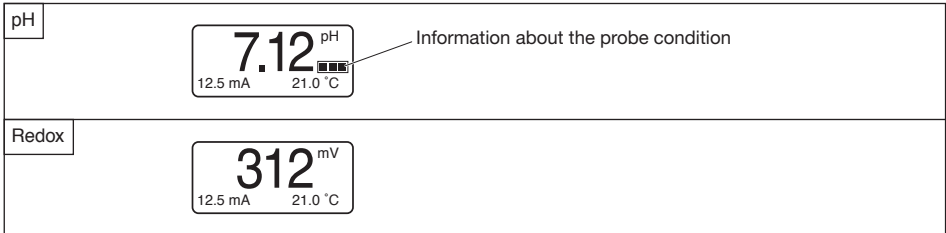

The permanent display allows you to monitor the DMT measured values during operation.

The permanent display can indicate the following (depending upon general settings):

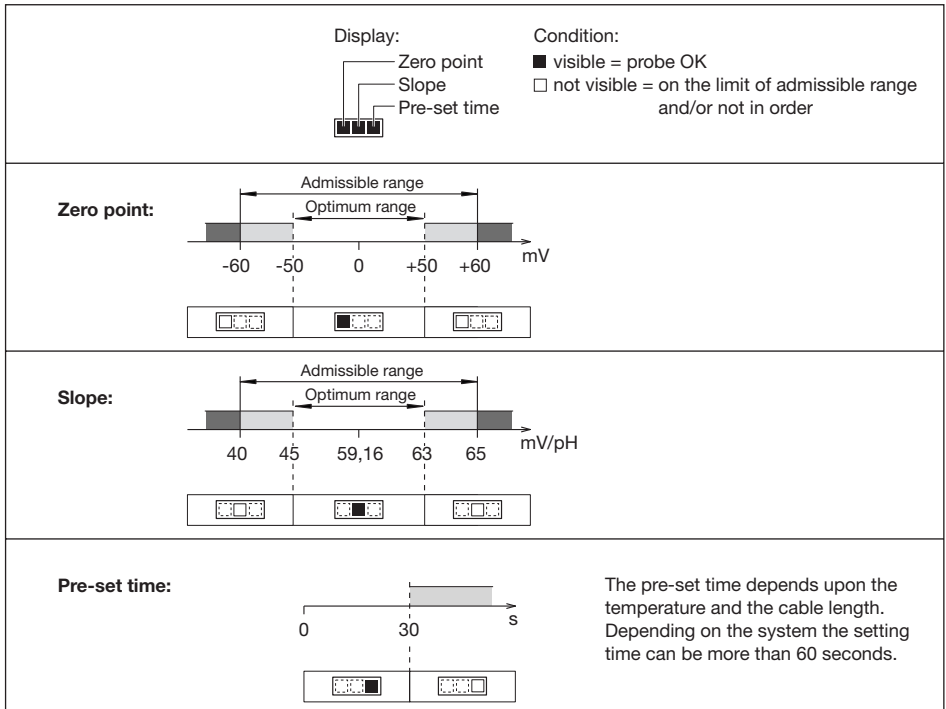

- Measured variable
- Correction variable
- Output current
- Information about the probe condition
- Error messages

8.1.1 Probe condition information (pH only)



8.1.2 Brightness of LC display

You can alter the brightness of the LC display in the permanent display:

- ▶ Increase brightness using the down arrow key  or reduce using the up arrow key .

8.2 Calibrating the pH meter

The pH probe condition is a key factor in the quality of the measurement. The pH probe must therefore be re-calibrated at regular intervals with the aid of buffer solutions. The DMT incorporates automatic buffer detection.

8.2.1 Automatic buffer detection

The tables for the following two buffer solution sets are contained in the program memory.

Temp.	ProMinent buffer table			DIN 19266 buffer table		
°C	pH			pH		
0	4.05	7.13	10.26			
5	4.04	7.07	10.17	4.00	6.95	10.25
10	4.02	7.05	10.11	4.00	6.92	10.18
15	4.01	7.02	10.05	4.00	6.90	10.12
20	4.00	7.00	10.00	4.00	6.88	10.07
25	4.00	6.98	9.94	4.01	6.86	10.01
30	4.00	6.98	9.90	4.01	6.85	9.97
40	4.00	6.97	9.82	4.04	6.84	9.89
50	4.00	6.96	9.75	4.06	6.83	9.83
60	4.00	6.97	9.68	4.09	6.84	
70	4.01	6.98	9.62	4.13	6.85	
80	4.02	6.99	9.55	4.16	6.86	

We recommend that you use the buffer solutions obtainable from ProMinent for calibration purposes.

Select a buffer set which is higher than the general setting (see chapter 7.1.7)

If **V = automatic adjustment** has been selected the corrected values are saved and used for buffer detection during the subsequent calibration process.

On delivery the program memory contains the ProMinent buffer table as the V-table.

8.2.2 The calibration process

NOTE

- The back key  can be used to exit the calibration menu at any time. You will then return to the permanent display.
- The output current is frozen for the duration of the calibration at, depending upon general settings, the last measured value (HOLD) or at 23 mA (see chapter 7.1.7 General settings).
- Inadmissible values render the ongoing calibration invalid. The previous calibration values are retained. The error messages are explained in chapter 9.2.
- Please dispose of spent buffer solution.

Calibration menu overview

8.2.2.1 2 point calibration

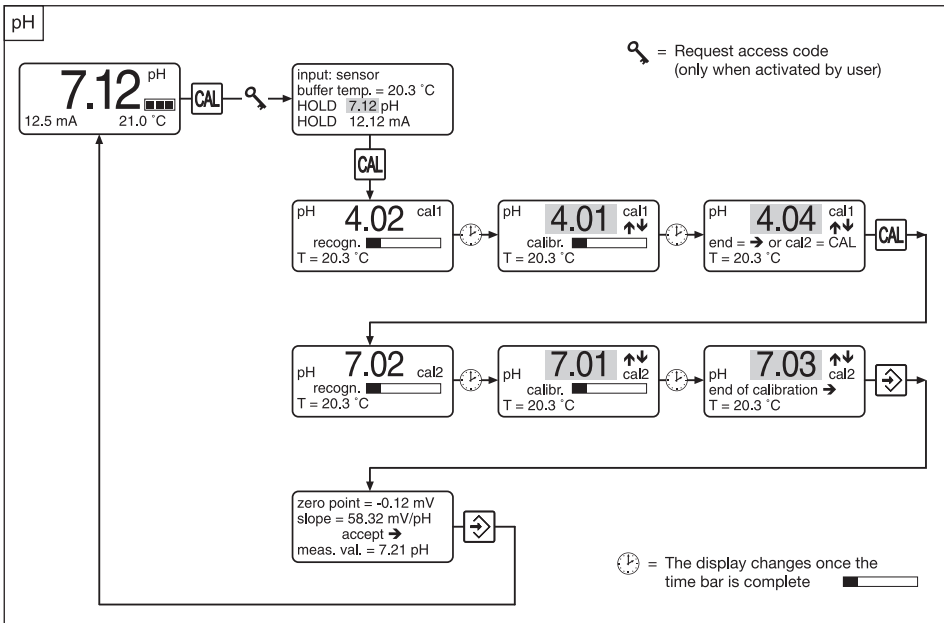

8.2.2.2 1 point calibration

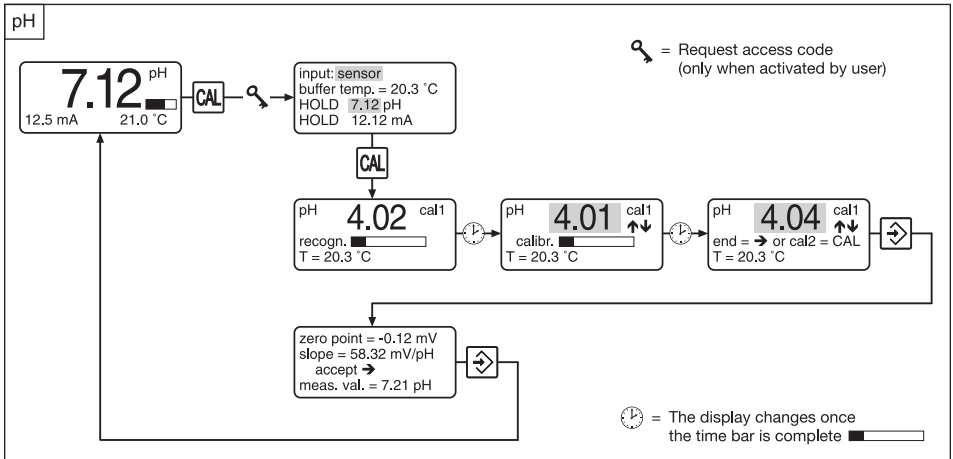

Proceed as follows to call up the calibration menu:

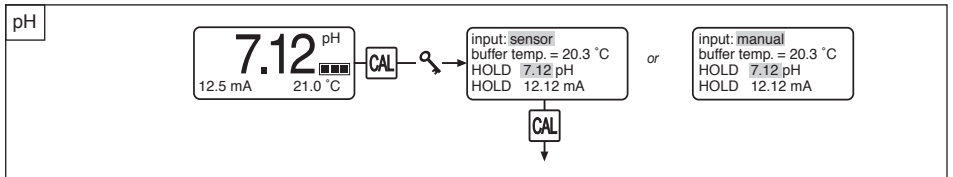

Starting calibration

- ▶ Press the CAL key **CAL** when in the permanent display mode while the pH probe is immersed in the liquid sample.
- ▶ Under “input” set the detection method of the buffer temperature (correction value):
Sensor (if the pH sensor incorporates a temperature gauge) or
manual (if using a separate temperature gauge).
 If you select **manual**, you must set the buffer temperatures under “buffer temp.” using the up and down arrow **↓** / **↑** keys.
 This setting is only valid during calibration.
- ▶ You can change the pH HOLD value under “HOLD”. This setting is only valid during calibration.
- ▶ Remove the pH probe from the liquid sample, rinse and immerse in the first buffer solution.
- ▶ Press the CAL key **CAL** to start automatic buffer detection:

Operating the DMT

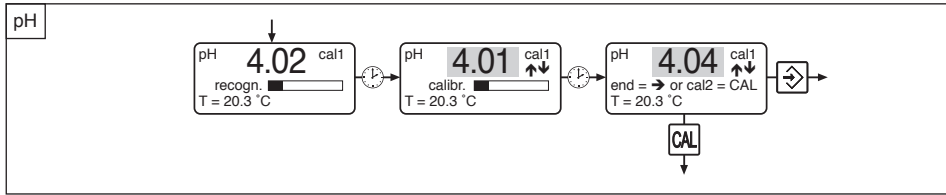

The progress of the buffer detection is indicated by a time bar. The calculation of the calibration parameters begins automatically after the buffer detection. This is also indicated by a time bar.

If you have selected **sensor** as the detection method for the buffer temperature, the current measured buffer temperature is displayed under “T”. If you have selected **manual**, the manually entered buffer temperature is displayed under “T”.

The buffer value can be corrected during calibration using the \downarrow / \uparrow arrow keys. If the sensor signal is unstable the time bar will wait until it becomes stable.

- ▶ After completion of this calibration stage the display shows the next menu option for 1 point calibration:
The buffer value can be corrected once again at this point using the arrow keys \downarrow / \uparrow .

Progress from this point onwards depends upon whether you have selected a 1 point calibration or a 2 point calibration (**recommended!**).

1 point calibration

- ▶ Press the enter key \diamond to end 1 point calibration.

The zero point is calibrated if the buffer value is between 5.5 pH and 8.0 pH. The slope is calibrated if the buffer value is less than 5.5 pH or greater than 8.0 pH.

- ▶ Proceed as for “conclude calibration”.

2 point calibration

- ▶ For a 2 point calibration remove the pH probe from the first buffer solution, rinse and immerse in the second buffer solution.
- ▶ Press the CAL key \square to restart automatic buffer detection.

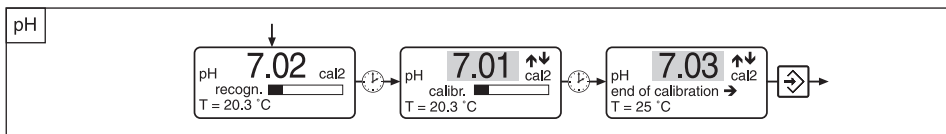

Buffer detection and calibration take place as described above.

- ▶ After completion of this calibration stage the display shows the next menu option for 2 point calibration:
The buffer value can be corrected once again at this point using the arrow keys \downarrow / \uparrow .
- ▶ Press the enter key \diamond to end 2 point calibration.
- ▶ Proceed as for “conclude calibration”.

Conclude calibration

The calibration values (zero point and slope) are now displayed:



The current pH value is shown under “meas. val.”.

- ▶ Press the enter key \diamond to adopt the values or the back key \leftarrow to exit without saving the values.

The display changes to permanent display. The calibration is complete.

NOTE

Inadmissible values render the current calibration process invalid. The previous calibration values are retained. The error messages during calibration are explained in chapter 9.2.

9 Troubleshooting

9.1 Error messages during operation

The following error messages can appear in the permanent display during operation:

Message	Displayed value	Cause of fault	Remedy
Output overflow	Measured value	Warning: detected current value <i>greater</i> than pre-set 20 mA value	Change configuration if necessary
Output underflow	Measured value	Warning: detected current value <i>less</i> than pre-set 4 mA value	Change configuration if necessary
pH input error !	-2.00 pH or 16.00 pH	Probe not present or lead damaged	Check probe connection (switch off probe check if necessary)
pH input error !	~7.00 pH	Short circuit (probe resistance = 0 Ω)	Check probe connection
defective pH probe !!	Measured value	Measured probe resistance < 2 MΩ	Replace probe (switch off probe check if necessary)
ORP input error !		Measured value > 1200 mV or < -1200 mV, resp. fluctuating significantly	Check probe connection
temp. input error !	999.9 °	Probe not present or lead damaged	Check probe connection (set temperature measurement to manual if necessary)
temp. input error !	-99.9 °	Short circuit	Check probe connection (set temperature measurement to manual if necessary)

The error message disappears automatically once you have remedied the fault.

9.2 Error messages while calibrating the pH meter

The following error messages can appear in the corresponding menu options during calibration:

Error message	Cause	Effect
Zero point <-60mV !!! Calibration failed	$N < -60 \text{ mV}$	Previous zero point and slope retained Replace probe
Zero point > 60mV !!! Calibration failed	$N > +60 \text{ mV}$	"
Slope < 40mV/pH ! Calibration failed	$S < 40 \text{ mV/pH}$ ($S < 67 \%$)	"
Slope > 65mV/pH ! Calibration failed	$S > 65 \text{ mV/pH}$ ($S > 111 \%$)	"

Warning	Cause	Effect
Measured value unstable !!!	$t_{\text{cal}} > 30 \text{ s}^*$	
Buffer differential < 2 pH !	$\Delta_{\text{Buffer}} < \text{pH } 2$	Use second buffer solution
False buffer value	-	Set correct buffer value

* The admissible setting time is: $t_{\text{cal}} < 30 \text{ s}$ for a value fluctuation $\Delta U < 2 \text{ mV/s}$



IMPORTANT

The sensor monitoring is deactivated during the calibration process!

10 Maintenance and repair

Maintenance The DMT requires no maintenance.
You should clean the housing with a damp, soapy cloth and then rub dry.



IMPORTANT

Solvents may attack the surfaces and must not be used.

Repair Please return the DMT to ProMinent Dosiertechnik GmbH for repair.

11 Disposal



IMPORTANT

Electronic waste is treated as special waste!

Observe current nationally and locally applicable directives.

12 Technical data

Electrical data

<i>Device</i>	Protection class:	III
	Supply voltage:	- 4-20 mA (two wire) current loop, 24 V DC (16...40 V DC), protective low voltage - PROFIBUS®-DP, 24 V DC (16...30 V DC), protective low voltage The supply voltage level must not fall below 16 V at any time
	Signal output:	4 ... 20 mA in normal operation, 23 mA to signal fault, Ohmic resistance 50 Ω

Enclosure ratings

When installed correctly the following enclosure ratings apply:

Wall/pipe mounted:	IP 65 in accordance with DIN VDE 0470-1
Control panel mounted:	IP 54 in accordance with DIN VDE 0470-1

Measured variable, pH

Measurement range:	-1 ... +15 pH at 0 ... 100 °C
Reproducibility:	0.01 pH
Operating measurement deviation:	max. 0.02 pH at 25 °C ambient temperature
Insulation voltage:	500 VDC; electrically insulated against ring circuit
Input resistance:	Glass electrode: > 10 ¹² Ω
Reference electrode:	All reference electrodes can be connected to diaphragm
Resolution:	0.01 pH

Measured variable, redox

Measurement range:	-1200 ... +1200 mV
Reproducibility:	1 mV
Operating measurement deviation:	max. 2 mV at 25 °C ambient temperature
Insulation voltage:	500 VDC; electrically insulated against ring circuit
Input resistance:	> 10 ¹² Ω
Reference electrode:	All reference electrodes can be connected to diaphragm

Measured variable/Correction variable, temperature

Resolution:	1 mV
Measurement range:	-20 °C ... 150 °C
Measurement deviation:	max. 0.3 °C (PT 1000 at 25 °C ambient temperature) max. 0.5 °C (PT 100 at 25 °C ambient temperature)

Resolution:	0.1 °C
Principle:	LCD (liquid crystal display)

Ambient conditions

Operating temperature:	-5 ... 55 °C
Storage temperature:	-20 ... 70 °C
Air humidity:	max. 95 % rel. humidity, non condensing

Dimensions and weight

Dimensions:	Wall/pipe mounted version 126x136x78 mm (WxHxD) Panel mounted version 35 mm, 30 mm (D _i , D _o)*
Weight:	Wall mounted, 450 g Panel mounted, 300 g *D _i = depth inside, D _o = depth outside
Admissible cable diameters:	threaded connector: M 20 x 1.5: Terminal area Ø 2 ... Ø 7 mm (SW 22) M 16 x 1.5: Terminal area Ø 5 ... Ø 10 mm (SW 19) reducers: M 20: Terminal area Ø 4 ... Ø 13 mm M 16: Terminal area Ø 3 ... Ø 9 mm
Admissible lead cross sections:	0.14 ... 0.75 mm ²
Admissible screen diameters:	Ø 2 ... Ø 5 mm

Material information

Housing:	PPE-GF10
Wall/pipe bracket:	PPE-GF20
Keypad:	Silicon
Housing seal:	Silicon

13 Spare parts and accessories

Assembly kit for wall/pipe mounting	Order no. 1003205
Pipe clamps for pipe mounting	Order no. 1002777
Plug-in power supply 90-264 V AC/24 V DC	Order no. 1006100
Probes	See product catalogue
Probe cable	See product catalogue

NOTE

Please give the identity code when ordering electronic component kits.

EC Declaration of Conformity

We,

**ProMinent Dosiertechnik GmbH
Im Schuhmachergewann 5 - 11
D - 69123 Heidelberg**

hereby declare that, on the basis of its functional concept and design and in the version brought into circulation by us, the product specified in the following complies with the relevant, fundamental safety and health stipulations laid down by EC directives.

Any modification to the product not approved by us will invalidate this declaration.

Product description : *Dulcometer transducer*

Product type : *DMTa*

Serial number : *see type identification plate on device*

Relevant EC regulations : *EC - EMC - regulation (89/336/EEC subsequently 92/31 EEC)*

Harmonised standards used,
in particular : *DIN EN 50081-1/2, DIN EN 50082-1/2
DIN EN 55011*

National standards and other
technical specifications used,
in particular :

Date/manufacturer's signature : *October 11, 1999*

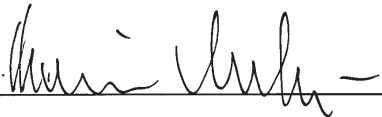

The undersigned :

Dr. Rainer V. Dulger, Executive Vice President R&D and Production

Terminal connection plan pH/redox/temperature

Inputs, connection variations

Output

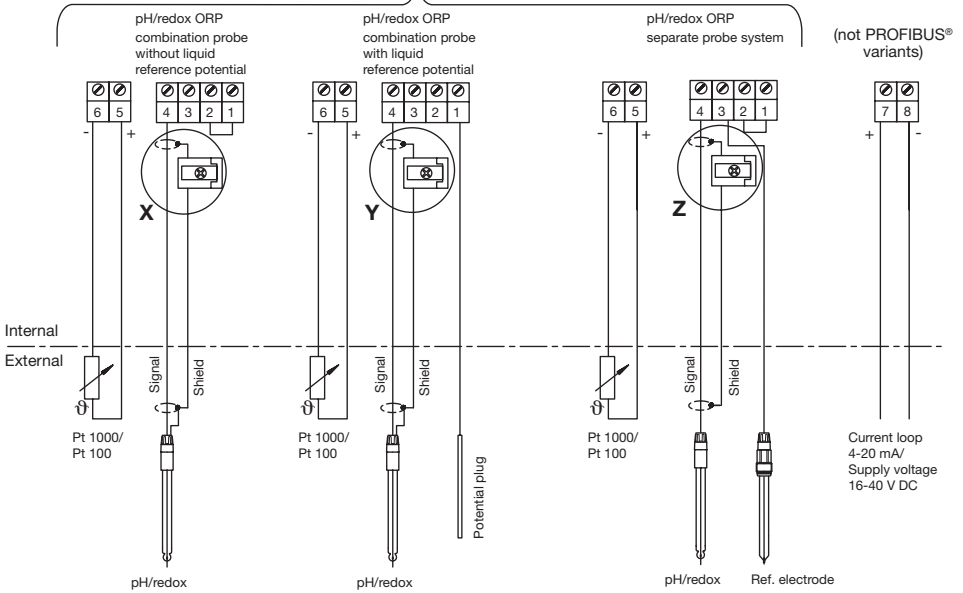

Detail X

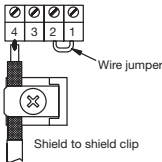

Detail Y

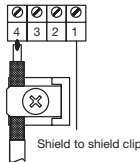

Detail Z

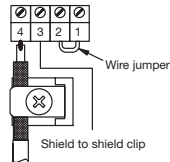

Connection variant temperature

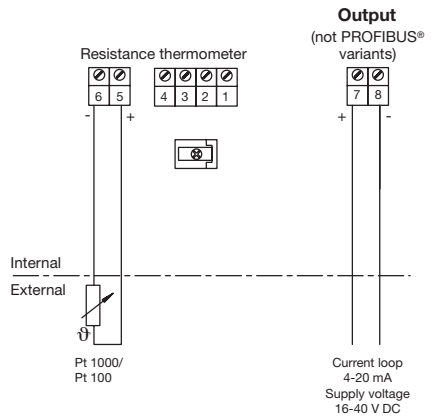

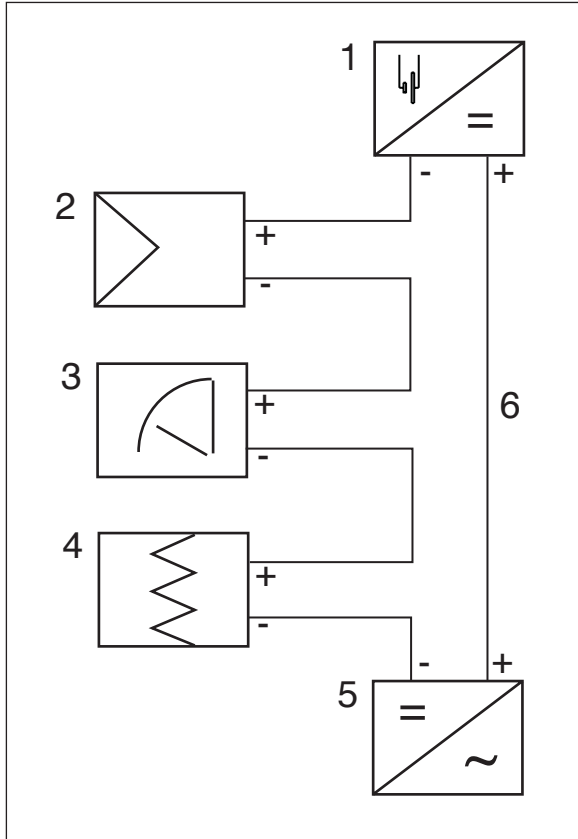

- 1 DMT transducer
- 2 Controller
- 3 Meter
- 4 Recorder
- 5 24 V DC (16...30 V DC/40 V DC) power supply unit
- 6 4-20 mA current loop



IMPORTANT

- *The signal inputs of all devices in the current loop must be electrically isolated from the current output.*
- *Take into account the sum of the ohmic resistances of all devices in the current loop (excluding power supply). The input voltage of the transducer must never drop below 16 V during operation. The measured value will otherwise be wrong.*

PROFIBUS®-DMT power supply

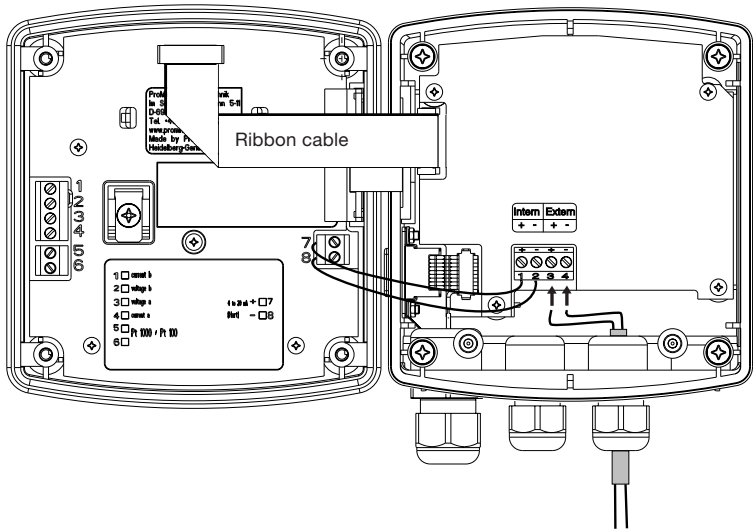

Supply voltage
16-30 V DC

NOTE

To operate the PROFIBUS®-DMT temporarily without the PROFIBUS®, unplug the ribbon cable (see fig.) and briefly disconnect from the power supply.

To operate the PROFIBUS®-DMT with the PROFIBUS® again, plug the ribbon cable back in (plug in the connector on the side of the PROFIBUS® circuit board with the red edge of the ribbon cable facing upwards (see fig.)). Briefly disconnect from the power supply.

A

Access code 32

B

Buffer detection 39, 41
 General settings 31

C

Calibration
 fault messages 44
 pH meter 39
 Pt 100 28
Calibration menu 40
 menu overview 40
Conformity declaration 48
Control elements 17
Check ORP probe 25

D

Device type 31

F

Fault message
 during operation 43
 during calibration 44

G

General settings 31
 changing 31

I

Identity code
 measured variable pH 5
 measured variable redox 6
 measured variable temperature 7
Info display 20, 21
Installation 13

K

Key functions 19

L

Language
 general settings 31
LC display
 brightness 39

M

Menu option 21
Menu overview
 calibration menu 40
 measured variable pH 23
 measured variable redox 24
 measured variable temperature 33
 tabular 22
Mounting 10

O

Operating 38
Operating menu 20
 schematic 19
Output

 General settings 31, 32, 36
 parameters 28, 34

P

Parameters
 output 28, 34
 measurement 25
 temperature 26, 34
Permanent display 38
Probe check (pH) 25
Probe condition (pH) 38
Probe type (temperature)
 general settings 36
PROFIBUS® 16, 50

S

Settings 22
Slope 25, 42

T

Temperature measurement
 parameters 26, 34
Temperature gauge
 general settings 31, 32, 36
Terminal connection plan 49
 Troubleshooting 43
2-wire system 51
Typical wiring for a 2-wire system 51

Z

Zero point 25, 42

Drilling template for DMT

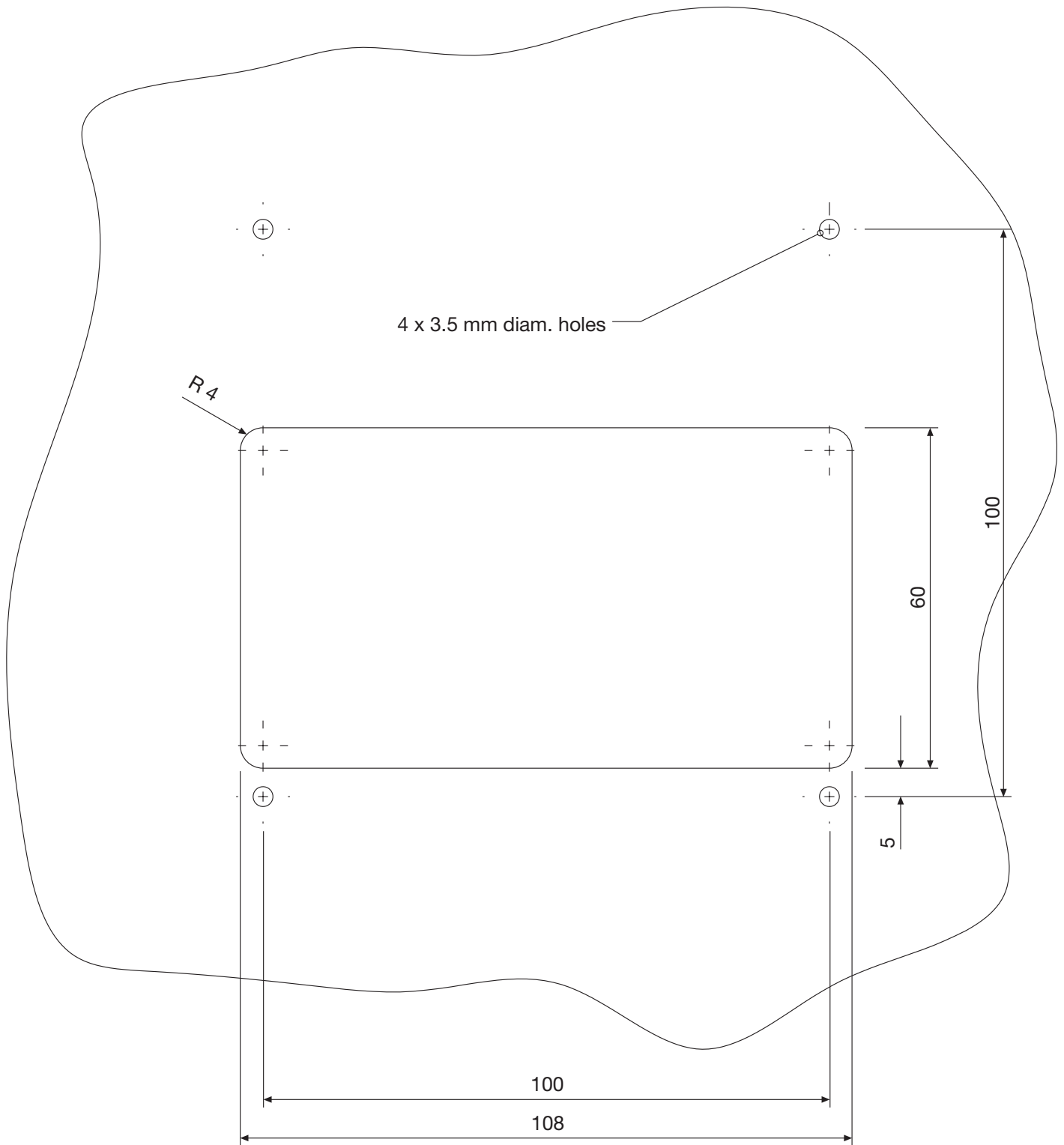

3460-4.1

ATTENTION: Photocopying the template can change the scale!

**Addresses and delivery information
from the manufacturer:**

ProMinent Dosiertechnik GmbH
Im Schuhmachergewann 5-11
69123 Heidelberg
Germany

Telephone: +49 6221 842-0
Fax: +49 6221 842-419
info@prominent.com
www.prominent.com