

Operating instructions

Solenoid Metering Pump

gamma/ XL, GXLa

EN



Target group: at least "instructed personnel" unless otherwise required.

**Please carefully read these operating instructions before use. · Do not discard.
The operator shall be liable for any damage caused by installation or operating errors.
The latest version of the operating instructions are available on our homepage.**

Supplementary information



Fig. 1: Please read!

Read the following supplementary information in its entirety! You will benefit more from the operating instructions should you already know this information.

The following are highlighted separately in the document:

- Enumerated lists

- Instructions
 - ⇒ Outcome of the instructions

🔗 *'State the identity code and serial number' on page 2:* Links to points in this chapter

- refer to ... : References to points in this document or another document

[Keys]

'Menu level 1 → Menu level 2 → Menu level ...': Menu paths

'Software interface texts'

Information



This provides important information relating to the correct operation of the unit or is intended to make your work easier.

Safety information

Safety information is identified by pictograms - see "Safety Chapter".

State the identity code and serial number

Please state the identity code and serial number, which you can find on the nameplate or in the menu under *'Setting / Menu → Information'* when you contact us or order spare parts. This enables us to clearly identify the unit type and material version.

General non-discriminatory approach

In order to make it easier to read, this document uses the male form in grammatical structures but with an implied neutral sense. It is aimed equally at both men and women. We kindly ask female readers for their understanding in this simplification of the text.

Table of contents

1	Identity code	6
2	About This Pump	9
3	Safety chapter	10
	3.1 Labels.....	10
	3.2 Intended use.....	11
	3.3 Safety information.....	11
	3.4 Information in the event of an emergency.....	14
	3.5 Personnel qualification.....	14
4	Storage, Transport and Unpacking	16
5	Overview of equipment and control elements	17
	5.1 Overview of equipment.....	17
	5.2 Control elements.....	18
	5.2.1 Control elements.....	18
	5.2.2 Key functions.....	21
6	Functional description	23
	6.1 Liquid End.....	23
	6.2 Drive unit.....	23
	6.3 Dosing rate.....	25
	6.4 Self-degassing.....	25
	6.5 Operating modes.....	25
	6.6 Functions.....	26
	6.7 Relays (options).....	26
	6.8 LED displays.....	27
	6.9 Hierarchy of operating modes, functions and fault statuses.....	27
7	Assembly	29
8	Installation, hydraulic	30
	8.1 Installing hose lines.....	31
	8.1.1 Installation with metering pumps without degassing.....	31
	8.1.2 Installation with metering pumps with degassing.....	33
	8.2 Basic installation notes.....	33
9	Installation, electrical	35
	9.1 Supply voltage connector - power supply.....	36
	9.2 HMI operating unit.....	37
	9.3 Description of the terminals.....	37
	9.3.1 "Config I/O" terminal.....	37
	9.3.2 "External control" terminal.....	38
	9.3.3 "Level switch" terminal.....	40
	9.3.4 "Metering monitor" terminal.....	41
	9.3.5 "Diaphragm rupture indicator" terminal.....	41
	9.3.6 Relays.....	42
10	Basic set-up principles	46
	10.1 Basic principles for setting up the control.....	46
	10.2 Checking adjustable variables.....	48
	10.3 Changing to Setting mode.....	48
11	Set up / 'Menu'	49
	11.1 'Information'.....	49

11.2	<i>'Settings'</i>	49
11.2.1	<i>'Operating mode'</i>	50
11.2.2	<i>'Automatic'</i>	55
11.2.3	<i>'Stroke length'</i>	55
11.2.4	Metering.....	56
11.2.5	Concentration.....	60
11.2.6	Calibrate.....	67
11.2.7	System.....	68
11.2.8	Inputs/outputs.....	70
11.2.9	Config-I/Os.....	76
11.2.10	Bleeding.....	76
11.2.11	<i>'Priming time'</i>	77
11.2.12	<i>'Set time'</i>	78
11.2.13	<i>'Date'</i>	78
11.3	Timer.....	78
11.3.1	Activation / deactivation.....	79
11.3.2	Setting the timer.....	79
11.3.3	Clear all.....	87
11.3.4	Examples.....	87
11.3.5	Timer information.....	91
11.3.6	Typical pitfalls Timer functional faults.....	91
11.3.7	Brief explanation of selected functions.....	92
11.4	<i>'Service'</i>	93
11.4.1	<i>'Access protection'</i>	93
11.4.2	<i>'Password'</i>	94
11.4.3	<i>'Clear counters'</i>	94
11.4.4	<i>'Error log book'</i>	94
11.4.5	<i>'Diaphragm replacement'</i>	95
11.4.6	<i>'Display'</i>	95
11.4.7	<i>'Factory settings'</i>	95
11.4.8	Diaphragm part number: XXXXXXXX.....	95
11.4.9	Spare parts kit part number: XXXXXXXX.....	95
11.5	<i>'Language'</i>	96
12	Operation.....	97
12.1	Manual operation.....	97
13	Maintenance.....	99
14	Repair.....	101
14.1	Replacing the diaphragm.....	102
14.1.1	Replacing the vPTFE diaphragm.....	103
14.2	Cleaning the diaphragm rupture indicator.....	104
14.3	Cleaning valves.....	104
15	Troubleshooting.....	105
15.1	Faults without a fault message.....	105
15.2	Faults with error message.....	106
15.2.1	Fault messages on the LCD screen.....	106
15.2.2	Warning messages on the LCD screen.....	108
15.2.3	All other faults.....	109
15.3	Log book.....	109
15.3.1	Fault messages in the log book.....	109
15.3.2	Warning messages in the log book.....	110
15.3.3	Event messages in the log book.....	111

	15.3.4 Log book entry - Detailed view.....	112
16	Decommissioning and disposal.....	113
17	Technical data.....	115
	17.1 Performance data.....	115
	17.1.1 Performance data with vPTFE diaphragm.....	116
	17.2 Accuracy.....	116
	17.2.1 Standard Liquid End.....	116
	17.2.2 Self-Bleeding Liquid End.....	116
	17.3 Viscosity.....	117
	17.4 Material specifications.....	117
	17.5 Electrical data.....	118
	17.6 Temperatures.....	118
	17.7 Climate.....	118
	17.8 Altitude of site	119
	17.9 Degree of protection and safety requirements.....	119
	17.10 Compatibility.....	119
	17.11 Weight.....	119
	17.12 Sound pressure level.....	119
18	Exploded drawings of the gamma/ XL.....	120
19	Dimensional drawings.....	135
20	Declaration of Conformity for Machinery.....	141
21	UK Declaration of Conformity	142
22	Operating / set-up overview gamma/ XL.....	143
23	gamma/ XL operating menu, overall.....	145
24	Continuous displays and secondary displays.....	152
25	Installation instructions: Retrofitting, relays.....	154
26	Index.....	155

1 Identity code



Product identification

This identity code serves to identify the product.

Use the identity code from the Product Catalogue for orders.

Product range gamma/ XL

GXLa	Type	
	----	Performance data and type - see nameplate
		Dosing head material
	NP	Clear acrylic
	PV	PVDF
	SS	Stainless steel
		Seal material
	T	PTFE
	F	PTFE, FDA-compliant
		Dosing head version
	0	without bleed valve, without valve spring
	1	without bleed valve, with valve spring
	2	with bleed valve, without valve spring
	3	with bleed valve, with valve spring
	4	without bleed valve, with valve spring for more high-viscosity media (HV)
	7	self-bleeding with groove (SER)
		Hydraulic connector
	0	Standard connector in line with technical data
	5	Connector for 12/6 hose, suction side standard
	F	Connector on discharge side for 8/4 hose, standard on suction side
		Diaphragm rupture indicator
	0	without diaphragm rupture indicator
	1	with diaphragm rupture indicator, optical sensor, electrical signal
		Design
	0	Housing RAL5003 / Hood RAL2003
		Logo
	0	with ProMinent logo
	2	without ProMinent logo
		Electrical connection
	U	100-230 V ± 10%, 50/60 Hz
		Cable and plug

Product range gamma/ XL

A	2 m European	
B	2 m Swiss	
C	2 m Australian	
D	2 m USA / 115 V	
1	2 m open end	
..	...	
Relay, pre-set to ...		
0	no relay	-
1	1 x changeover contact 230 V AC – 6 A	Fault indicating relay (N/C)
4	1 x N/O 24 V DC – 1 A 1 x N/O 24 V DC – 100 mA	as 1 + pacing relay
C	1 x N/O 24 V DC – 100 mA, and 1 x 4-20 mA output	As 1 + 4-20 mA output
F	with automatic bleed valve	230 V AC
G	with automatic bleed valve and relay output	24 V DC
..	...	
Accessories		
0	no accessories	
1	with foot and injection valve, 2 m suction line, 5 m metering line	
2	as 0 + measuring cup	
3	as 1 + measuring cup	
Control version		
0	Manual + external contact with pulse control	
3	Manual + external contact with pulse control + analogue 0/4-20mA	
C	As 3 + CANopen	
P	As 3 + PROFINET®	
M	As 3 + Modbus RTU	
R	As 3 + PROFIBUS® interface, M12	
Communication		
0	without interface	
B	with Bluetooth	
W	with Wi-Fi	
Language		
EN	Deutsch	
EN	English	

2 About This Pump

About This Pump

Pumps in the gamma/ XL product range are microprocessor-controlled solenoid metering pumps with the following characteristics:

- Simple adjustment of the capacity directly in l/h
- Integrated pressure measurement and display for greater safety during commissioning and in the process
- Bluetooth and Wi-Fi connection for the simple configuration and call-up of process data (optional)
- Capacity adjustment range 1:40,000
- Direct input of the required final concentration with volume-proportional metering tasks in concentration mode
- Virtually wear-free solenoid drive, overload-proof and economical
- Suitable for continuous micro-metering from approx. 5 ml/h, thanks to the regulated solenoid drive
- Detection of hydraulic malfunctions, such as gas in the dosing head, and no or too high back pressure, ensures smooth processes
- External control via potential-free contacts with pulse step-up and step-down
- External control via 0/4-20 mA standard signal, scalable
- Integrated 1-week/1-month timer
- Guaranteed metering by means of automatic bleeding
- Connection to process control systems via a BUS interface, such as PROFIBUS®, PROFINET®, CAN bus or Wi-Fi
- Automatic mode – volume settings only (l/h, ml/contact etc.)
- Non-automatic mode – settings via stroke length and stroke rate

3 Safety chapter



Cessation of statutory warranty claims

Do not open the unit! We would advise that the unit may only be opened by qualified personnel authorised by ProMinent to avoid damage to the unit and guarantee the seamless and safe operation of the unit. All warranty claims will be invalidated if the unit is opened by unauthorised persons. You forfeit warranty claims and claims for damages against ProMinent for damage caused by unauthorised persons opening the unit.

3.1 Labels

Identification of safety notes

The following signal words are used in these operating instructions to denote different severities of danger:

Signal word	Meaning
WARNING	Denotes a possibly dangerous situation. If this is disregarded, you are in a life-threatening situation and this can result in serious injuries.
CAUTION	Denotes a possibly dangerous situation. If this is disregarded, it could result in slight or minor injuries or material damage.

Warning signs denoting different types of danger

The following warning signs are used in these operating instructions to denote different types of danger:

Warning signs	Type of danger
	Warning – automatic start-up.
	Warning – high-voltage.
	Warning – danger zone.

3.2 Intended use



NOTICE!

Wear caused by "Pump ON/OFF" using the mains connection

Frequent switching of the pump on and off (>2 times each day) using the supply voltage leads to increased wear in the pump. The pump is not technically designed for this.

If necessary, use the "Pause" function to switch the pump to standby mode. Do not switch the pump on and off using the supply voltage to spare a pause input.

- Only use the pump to meter liquid feed chemicals.
- Only use the pump once it has been correctly installed and started up in accordance with the technical data and specifications contained in the operating instructions.
- Observe the general limitations with regard to viscosity limits, chemical resistance and density - see also the ProMinent Resistance List in the Product Catalogue or at www.prominent.com.
- All other uses or modifications are prohibited.
- The pump is not designed to meter gaseous media and solids.
- The pump is not designed to meter flammable media.
- The pump is not designed to meter explosive media.
- The pump is not intended for operation in areas at risk from explosion.
- The pump is not designed for use outdoors without appropriate protective measures.
- Only allow the pump to be operated by trained and authorised personnel, see the following "Qualifications" table.
- You have a duty to observe the information contained in the operating instructions during the different phases of the unit's service life.

3.3 Safety information



WARNING!

Warning about personal and material damage

The pump can start to pump, as soon as it is connected to the mains voltage.

- Install an emergency cut-off switch in the pump power supply line or integrate the pump in the emergency cut-off management of the system.



WARNING!

Warning of personal injury and material damage

The pump can start pumping as soon as it has cooled down after the error '*temperature*'.

- Take this into account with the pump and your installation.



WARNING!

Danger of electric shock

Supply voltage may be present inside the pump housing.

- Safely and quickly disconnect the pump from the mains/power supply if the pump housing has been damaged.
Only return the pump to operation after an authorised repair.



WARNING!

Warning of hazardous feed chemical

Should a dangerous feed chemical be used: it may escape from the hydraulic components when working on the pump, material failure or incorrect handling of the pump.

- Take appropriate protective measures before working on the pump (e.g. safety glasses, safety gloves, ...). Adhere to the material safety data sheet for the feed chemical.
- Drain and flush the liquid end before working on the pump.



WARNING!

Danger from hazardous substances!

Possible consequence: Fatal or very serious injuries.

Please ensure when handling hazardous substances that you have read the latest safety data sheets provided by the manufacture of the hazardous substance. The actions required are described in the safety data sheet. Check the safety data sheet regularly and replace, if necessary, as the hazard potential of a substance can be re-evaluated at any time based on new findings.

The system operator is responsible for ensuring that these safety data sheets are available and that they are kept up to date, as well as for producing an associated hazard assessment for the workstations affected.



CAUTION!

Warning of feed chemical spraying around

Feed chemical may spray out of the hydraulic components if they are tampered with or opened due to pressure in the liquid end and adjacent parts of the system.

- Disconnect the pump from the mains power supply and ensure that it cannot be switched on again by unauthorised persons.
- Ensure that the system is at atmospheric pressure before commencing any work on hydraulic parts of the system.

Warning of feed chemical spraying around

- The metering pump may generate a multiple of its nominal pressure. Hydraulic parts may rupture if a pressure line is blocked.
- Install a relief valve in the pressure line downstream of the metering pump.

**CAUTION!****Warning of feed chemical spraying around**

An unsuitable feed chemical can damage the parts of the pump that come into contact with the chemical.

- Take into account the resistance of the wetted materials and the ProMinent Resistance List when selecting the feed chemical - see the ProMinent Product Catalogue or visit ProMinent.

**CAUTION!****Danger of injury to personnel and material damage**

The use of untested third party components can result in injury to personnel and material damage.

- Only fit parts to metering pumps that have been tested and recommended by ProMinent.

**CAUTION!****Danger from incorrectly operated or inadequately maintained pumps**

Danger can arise from a poorly accessible pump due to incorrect operation and poor maintenance.

- Ensure that the pump is accessible at all times.
- Adhere to the maintenance intervals.

Danger from incorrect dosing

- The metering behaviour of the pump changes if a different liquid end size is fitted.
- Reprogram the pump in the *'Menu / Information → Settings → System → Replace head type'* menu.

**CAUTION!****Warning against illegal operation**

Observe the regulations that apply where the device is installed.

Isolating protective equipment

- Cover of the slot for relays and optional modules - see the chapter entitled "Overview of equipment and control elements"

Customers should only remove the cover of the slot for relays and optional modules and/or a relay or optional module in line with the supplementary instructions for the relays and optional modules.

Customers should only remove the dosing head in accordance with the "Repair" chapter.

Only the ProMinent service department is authorised to open the housing and hood (housing the control elements).

Sound pressure level

Sound pressure level $L_{pA} < 70$ dB according to EN ISO 20361 at maximum stroke length, maximum stroke rate, maximum back pressure (water)

3.4 Information in the event of an emergency

Information in the event of an emergency

In an emergency, either disconnect the mains plug, press  [Start/Stop] or press the Emergency Stop switch installed on the customer's side or disconnect the pump from the mains/power supply in line with the Emergency Stop management guidelines for your system.

If feed chemical escapes, ensure that the pump's hydraulic environment is also at atmospheric pressure. Adhere to the material safety data sheet for the feed chemical.

3.5 Personnel qualification

Qualification of personnel

Task	Qualification
Storage, transport, unpacking	Instructed person
Assembly	Technical personnel, service
Planning the hydraulic installation	Qualified personnel who have a thorough knowledge of metering pumps
Hydraulic installation	Technical personnel, service
Installation, electrical	Electrical technician
Operation	Instructed person
Maintenance, repair	Technical personnel, service
Decommissioning, disposal	Technical personnel, service
Troubleshooting	Technical personnel, electrical technician, instructed person, service

Explanation of the table:

Qualified personnel

A qualified employee is deemed to be a person who is able to assess the tasks assigned to him and recognise possible dangers based on his/her technical training, knowledge and experience, as well as knowledge of pertinent regulations.

Note:

A qualification of equal validity to a technical qualification can also be gained by several years of employment in the relevant field of work.

Electrical technician

An electrical technician is able to complete work on electrical systems and recognise and avoid possible dangers independently based on his/her technical training and experience, as well as knowledge of pertinent standards and regulations.

The electrical technician should be specifically trained for the working environment in which he is employed and know the relevant standards and regulations.

An electrical technician must comply with the provisions of the applicable statutory directives on accident prevention.

Instructed person

An instructed person is deemed to be a person who has been instructed and, if required, trained in the tasks assigned to him/her and possible dangers that could result from improper behaviour, as well as having been instructed in the required protective equipment and protective measures.

Service

The Service department refers to service technicians, who have received proven training and have been authorised by ProMinent to work on the system.

4 Storage, Transport and Unpacking

Safety Information



WARNING!

Only return metering pumps for repair in a cleaned state and with a flushed liquid end - refer to "Decommissioning!"

Only return metering pumps with a completed Decontamination Declaration form. The Decontamination Declaration constitutes an integral part of an inspection / repair order. A unit can only be inspected or repaired when a Declaration of Decontamination Form is submitted that has been completed correctly and in full by an authorised and qualified person on behalf of the pump operator.

The "Decontamination Declaration Form" can be found on our homepage.



CAUTION!

Danger of material damage

The device can be damaged by incorrect or improper storage or transportation!

- The unit should only be stored or transported in a well packaged state - preferably in its original packaging.
- The packaged unit should also only be stored or transported in accordance with the stipulated storage conditions.
- The packaged unit should be protected from moisture and the ingress of chemicals.

Ambient conditions

Ambient conditions - refer to "Technical Data" chapter.

Scope of delivery

Compare the delivery note with the scope of delivery:

- Metering pump with mains cable
- Connector kit for hose/pipe connection (optional)
- Product-specific operating instructions with EC Declaration of Conformity
- Optional accessories

5 Overview of equipment and control elements

5.1 Overview of equipment

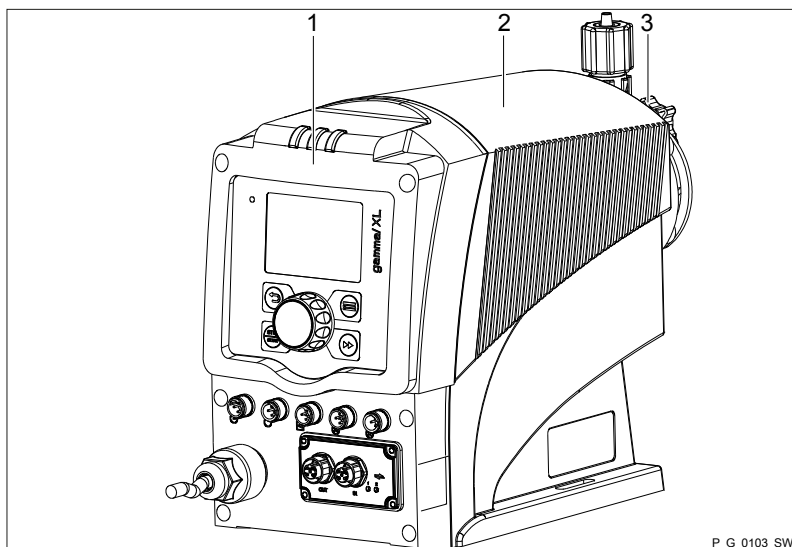

Fig. 2: Overview of equipment, complete

- 1 Control unit
- 2 Drive unit
- 3 Liquid end

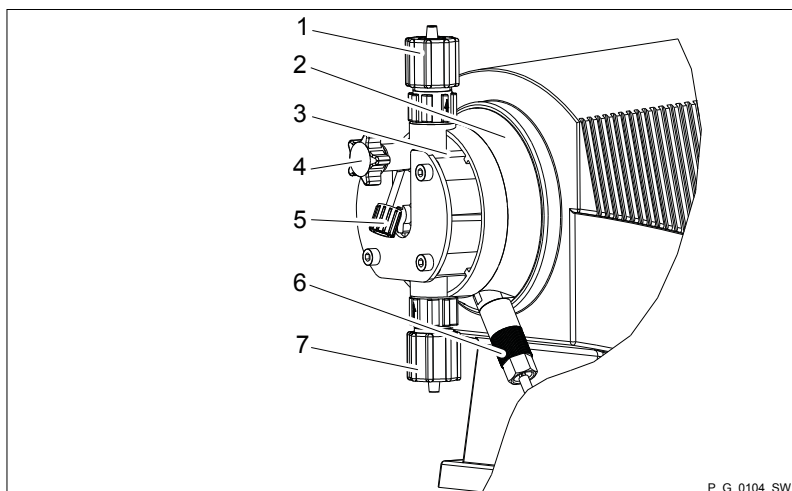

Fig. 3: Liquid end with PV bleed valve

- 1 Discharge valve
- 2 Backplate
- 3 Dosing head
- 4 Bleed valve
- 5 Bypass hose sleeve
- 6 Diaphragm rupture indicator (optional)
- 7 Suction valve



Self-bleeding liquid ends (SER)

Externally self-bleeding liquid ends with groove (SER) look identical to liquid ends with bleed valve.

5.2 Control elements

Control elements, overview

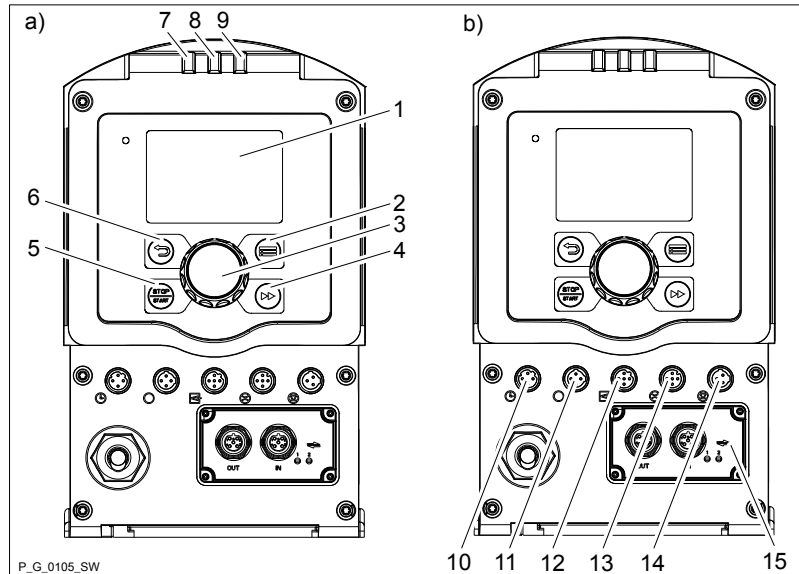

Fig. 4

- 1 LCD screen
- 2 [Menu] key
- 3 Clickwheel
- 4 [Priming] key
- 5 [STOP/START] key
- 6 [Back] key
- 7 Fault indicator (red)
- 8 Warning indicator (yellow)
- 9 Operating indicator (green)
- 10 "Config I/O" terminal
- 11 "Diaphragm rupture indicator" terminal
- 12 "External control" terminal
- 13 "Metering monitor" terminal
- 14 "Level switch" terminal
- 15 Slot for relays and optional modules

5.2.1 Control elements



Use this overview to familiarise yourself with the keys and the other control elements on the pump!

Pressure display, identifier and fault displays on the LCD screen

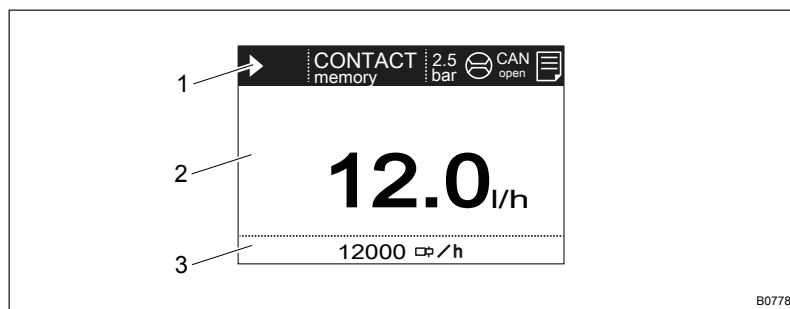

Fig. 5: Construction of continuous display

- 1 Status bar
- 2 Continuous display, central area
- 3 Secondary display

Refer to the chapter entitled "Main displays and secondary displays" in the Appendix for the different main displays and secondary displays.

The LCD screen supports the operation and adjustment of the pump by providing different information and identifiers:

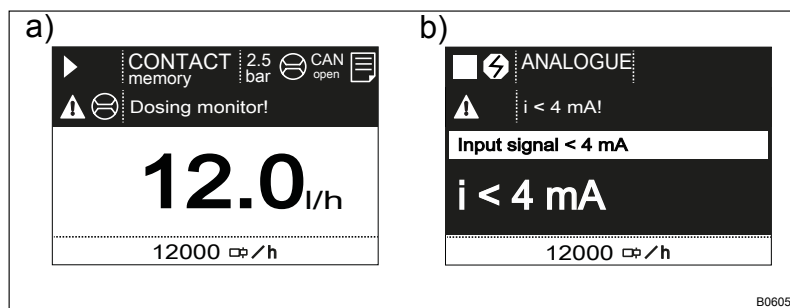

Fig. 6: a) Continuous display with warning message; b) Continuous display with fault message. Explanation of the symbols in the following tables.















The above Figure, Part a) shows that:







- The pump is in operation
- Is in 'Contact' operating mode with "memory" stroke memory
- The average system pressure is 2.5 bar
- A metering monitor is connected
- A CAN module is being used
- A log entry has been made
- A warning message for the 'metering monitor' is pending
- The capacity of 12.0 l/h has been set
- The stroke rate is 12,000 strokes / h

Tab. 1: Pressure display

Display	Meaning
2.5 bar	Displays the average system pressure

Tab. 2: Identifier and error displays:

Identifier	Meaning
	The pump is working or waiting for a starting signal.
	The pump was manually stopped using the  [STOP/START] key.
	The pump was remotely stopped (Pause) - via the "External" socket.
	The pump was stopped by an error.
	Only with cyclical batch metering: the pump is waiting for the next cycle.
	Only with 'Access. protect': the pump software is locked.
'AUX'	The pump is currently pumping at auxiliary capacity and/or auxiliary frequency.
'memory'	Only in 'CONTACT' and 'BATCH' operating modes: The "Stroke memory" auxiliary function has been set.
	The pump is in 'ANALOGUE' operating mode. The 'Curve → linear' type of processing is set.
	The pump is in 'ANALOGUE' operating mode. The 'Curve → Upper side band' type of processing is set.
	'Metering → Discharge stroke → optimum' metering profile has been set.
	'Metering → Discharge stroke → fast' metering profile has been set.
	'Metering → Discharge stroke → sine mode' metering profile has been set.
	'Metering → Discharge stroke → continuous' metering profile has been set.
	'Metering → Discharge stroke → DFMa' metering profile has been set.
	'Metering → Discharge stroke → normal' metering profile has been set.

Identifier	Meaning
	'Metering → Discharge stroke → HV1' metering profile has been set.
	'Metering → Suction stroke → HV2' metering profile has been set.
	'Metering → Suction stroke → HV3' metering profile has been set.
	A "Flow Control" metering monitor is connected.
	A diaphragm rupture indicator is connected.
	The pump has created a log about the operation.
	The pump is in the 'Menu' (Set up).







Further explanations can be found in the "Trouble-shooting" chapter.





The pump only shows the metering volume and the capacity in the calibrated state in l or l/h or in gal or gal/h.

5.2.2 Key functions

Key	Application	In the continuous displays	In the menu
 [Back]	press	-	Move back to the previous menu point (or a continuous display) - without saving
 [STOP/START]	press	Stop pump,	Stop pump,
		Start pump	Start pump
 [Menu]	press	Move to the menu	Move back to a continuous display
 [Priming]	press	Priming *	Priming *

Overview of equipment and control elements

Key	Application	In the continuous displays	In the menu
 [Clickwheel]	press	Start batch (only in 'Batch' operating mode), Acknowledge errors	Move to next menu option (or a continuous display) Confirm entry and save
 [Clickwheel]	turn	Switch between the continuous displays	Change figure or change selection



** When priming the pump does not run at maximum stroke rate.*



Refer to the "Set-up basics" chapter to adjust figures

6 Functional description

6.1 Liquid End

The dosing process is performed as follows: The diaphragm is pressed into the dosing head; the pressure in the dosing head closes the suction valve and the feed chemical flows through the discharge valve out of the dosing head. The diaphragm is now drawn out of the dosing head; the discharge valve closes due to the negative pressure in the dosing head and fresh feed chemical flows through the suction valve into the dosing head. One cycle is completed.

6.2 Drive unit

The diaphragm is driven by an electromagnet, controlled by an electronic control.

Drive technology

The drive technology on the gamma/ XL enables the timed progress of the flow to be precisely matched to the requirements of the particular application.

This ensures that the user can set the optimum **discharge stroke** for their application, as required:

Pos.*	Discharge stroke	Application
A.	<i>'optimum'</i>	For maximum precision when metering and the very best results with internal pressure measurement and special functions.
B.	<i>'fast'</i>	For a fast discharge stroke.
C.	<i>'sine mode'</i>	For a long, sine-shaped discharge stroke.
D.	<i>'continuous'</i>	For a continuous discharge stroke e.g. for continuous metering of smaller volumes. The duration of the discharge stroke is dependent on the stroke rate.
E.	<i>'DFMa'</i>	For optimum operation with a flow meter DulcoFlow® DFMa.

* see following drawing.

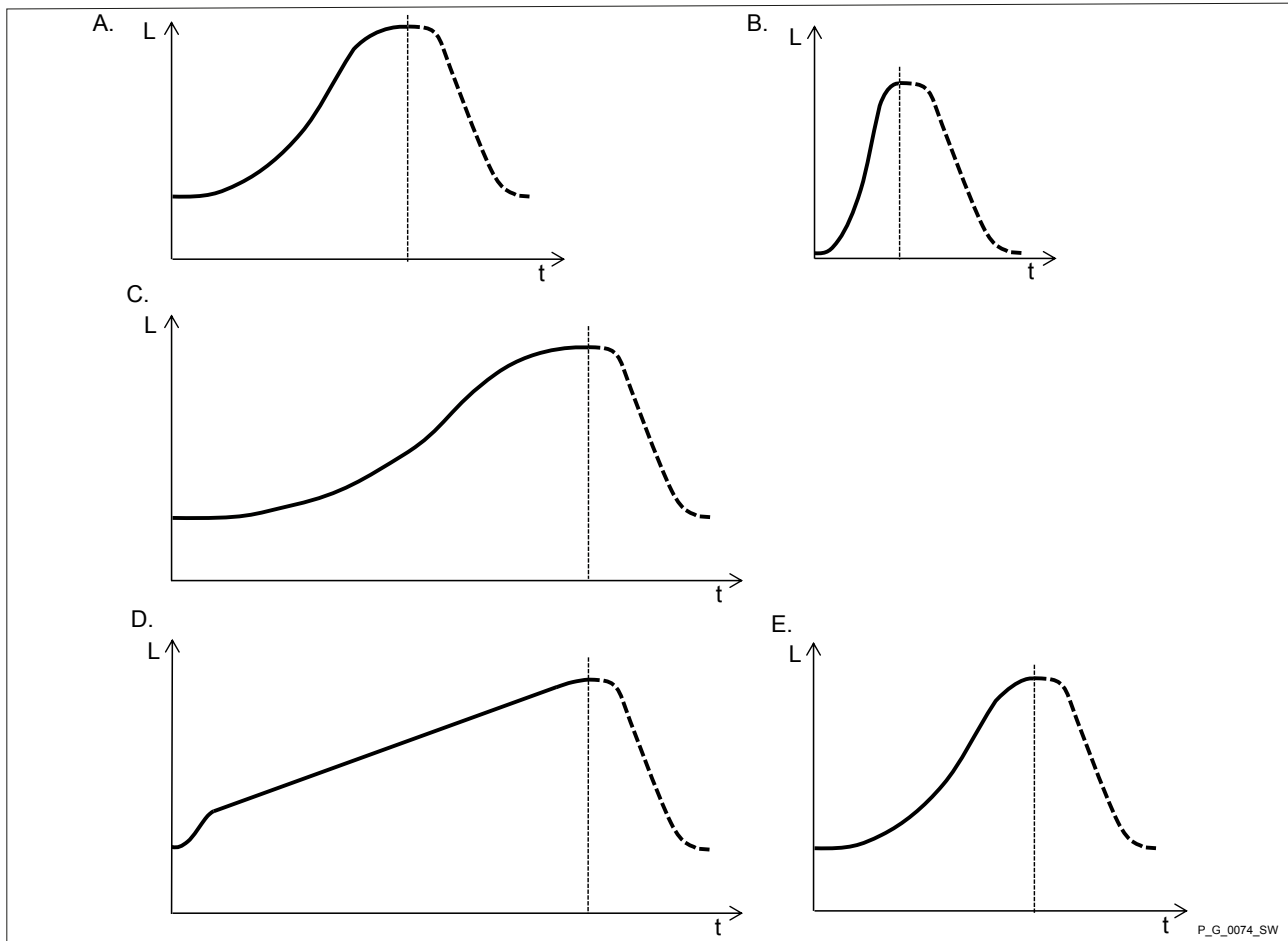

Fig. 7: Discharge stroke metering profiles with stroke L and time t (suction stroke shown as a dotted line)

It is possible to selectively also slow the **suction stroke** with all these metering profiles for the discharge stroke - see . In this way, it is possible to prevent the main cause of inaccurate metering with high viscosity feed chemicals, namely the incomplete filling of the liquid end. With gaseous feed chemicals, the slow suction stroke prevents cavitation and consequently increases dosing precision.

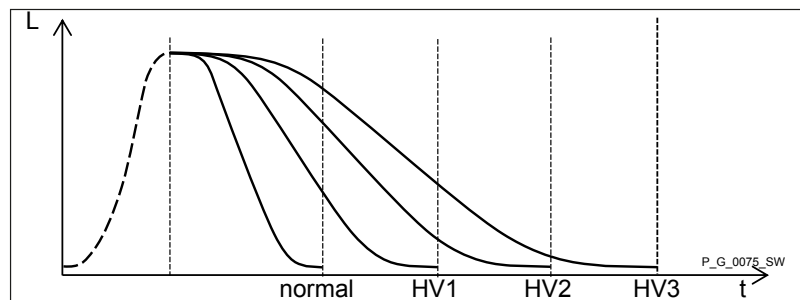

Fig. 8: Suction stroke metering profiles with stroke L and time t

- Normal Normal suction stroke
- HV1 Suction stroke for viscous feed chemical
- HV2 Suction stroke for average viscosity feed chemical
- HV3 Suction stroke for high-viscosity feed chemical

Back pressure oscillations in the dosing line, which could lead to undesirable variations in the metering volume, are automatically compensated for by the drive. This results in a **dosing precision** that could otherwise only be achieved with complex control circuits.

6.3 Dosing rate

The pump itself regulates the dosing rate that has been set in '*Automatic*' ON mode.

By contrast, in conventional mode ('*Automatic*'-OFF), the stroke length and stroke rate determine the dosing rate. The stroke length can be adjusted between 0 and 100% via the continuous display or the menu. Only a metering volume of between 30 to 100% is reproduced as being technically sensible! The stroke rate can be set via the menu (not in "Analog" operating mode) within a range of 0 - 12,000 strokes/h.

6.4 Self-degassing

SER types

Self-degassing liquid ends without bypass are capable of independent priming when a pressure line is connected and pumping any air locks present into the pressure line. During operation, they are also capable of conveying away gases that are produced, independently of the operating pressure in the system.

6.5 Operating modes

Operating modes are selected via the "Operating modes" menu.

Refer to the "Hierarchy of Operating Modes, Functions and Fault Statuses" for the order of the various operating modes, functions and fault statuses.

"Manual" operating mode

'Manual' operating mode permits you to operate the pump manually.

"Contact" operating mode

This operating mode provides the option of controlling the pump externally by means of potential-free contacts (e.g. by means of a contact water meter). The "Pulse Control" option allows you to pre-select the number of strokes (a step-down or step-up factor of 0.01 to 99.99) in the '*Settings*' menu.

"Batch" operating mode

This operating mode provides the option of working with large step-up factors (up to 99,999). Metering can be triggered either by pressing the *[Clickwheel]* or by a pulse received via the "External control" terminal by a contact or a semiconductor switching element. It is possible to pre-select a metering volume (batch) or a number of strokes using the *[Clickwheel]* in the '*Settings*' menu.

"Analog" operating mode

The dosing rate and/or stroke rate is controlled by an analogue current signal via the "External control" terminal. The processing of the current signal can be preselected using the control unit.

6.6 Functions

Refer to the "Hierarchy of Operating Modes, Functions and Fault Statuses" for the order of the various operating modes, functions and fault statuses.

The following functions can be selected using the '*Settings*' menu:

"Calibrate" function

The pump can also be operated in a calibrated state in all operating modes if it is to meter extremely precisely. Calibration should take place at the operating point and be retained over the entire stroke rate range and over a stroke length range of 0 - 100%.

"Auxiliary dosing rate" / "Auxiliary frequency" function

This facilitates the switch-over to a fixed dosing rate / stroke rate adjustable in the '*menu*' via the "External control" terminal.

"Degassing" function

It permits the pump to pump the gas bubbles out of the liquid end even without a vent valve (solenoid valve) – depending on the back pressure.

"Timer" function

This permits a simple timer program to be set up without the need for an additional timer module.

The following functions are available as standard:

"Flow monitor" function

It monitors whether a stroke has led to a pressure surge if a metering monitor is connected and if '*Fast*' is set under '*Settings* → *Metering* → *Discharge stroke*' or '*DFMa*' (for the DulcoFlow®). The number of defective strokes, after which the pump is switched off, can be set in the '*Settings*' menu.

"Level switch" function

Information about the liquid level in the dosing tank is reported to the pump. A two-stage level switch has to be fitted for this purpose, which is connected to the "Level switch" terminal. It is possible to connect a suction lance with continuous level measurement to pumps from 2019 onwards.

"Pause" function

The pump can be remotely stopped via the "External control" terminal.

"Stop" function

The pump can be stopped without disconnecting it from the mains/power supply by pressing  [*STOP/START*].

"Priming" function

Priming can be triggered by pressing  [*Priming*].

6.7 Relays (options)

The pump has several connecting options available:

"Fault indicating relay" option

The relay can close a connected power circuit (e.g. for an alarm horn) in the event of warnings or fault messages (e.g. *'Level warning'*).

The function of the relay can be programmed via the menu.

The relay can be retrofitted through the slot in the front of the pump – refer to the installation instructions for "Retrofitting relays".

"Fault indicating and pacing relay" option

This combined relay can generate a contact with each stroke via its pacing relay in addition to functioning as a fault indicating relay.

The function of the relay can be programmed via the menu.

The option can be retrofitted through the slot in the front of the pump – refer to the installation instructions for "Retrofitting relays".

"Automatic degassing" option

The "Automatic degassing" option is used for the controlled degassing of the liquid end. This option can be retrofitted through the slot in the front of the pump and conversion of the dosing head.

There are two versions:

- Version with 1 relay – to control the electric vent valve in the dosing head (identity code characteristic F, degassing module 3-pin, 230 V)
- Version with 2 relays – one relay to control the electric vent valve in the dosing head and one relay freely available (identity code characteristic G, degassing module 4-pin with relay, 24 V)

"mA-output" option

The current output signal I indicates the pump's actual calculated metering volume. The relay can be retrofitted through the slot in the front of the pump.

The option also always includes a relay.

6.8 LED displays

Fault indicator (red)

LED display	Colour	lit	briefly goes out	flashes
Fault indicator	red	A fault message is pending	-	undefined operating status
Warning indicator	yellow	A warning message is pending	-	-
Operating display	green	The pump is ready for operation	With each stroke	Stroke rate below 30 strokes / min.

6.9 Hierarchy of operating modes, functions and fault statuses

The different operating modes, functions and fault statuses have a different impact on whether and how the pump reacts.

The following list shows the order:

1. - Priming
2. - Stop
3. - Error, Pause
4. - Auxiliary dosing rate / Auxiliary frequency
5. - Manual, Analog, Contact, Batch, Fieldbus

Comments:

- re 1. - "Priming" can take place in any pump mode (providing it is working).
- re 2. - "Stop" stops everything apart from "Priming".
- re 3. - "Error", and "Pause" stop everything apart from "Priming".
- re 4. - "Auxiliary dosing rate" and/or "Auxiliary frequency" always have priority over the dosing rate / stroke rate specified by an operating mode listed under 5 or the fieldbus.

7 Assembly



Refer to the correct dimensional drawings for the pump from the online version of the operating instructions from our website. www.prominent.com



Compare the dimensions on the dimensional drawing with those of the pump.



CAUTION!

Danger from incorrectly operated or inadequately maintained pumps

Danger can arise from a poorly accessible pump due to incorrect operation and poor maintenance.

- Ensure that the pump is accessible at all times.
- Adhere to the maintenance intervals.



Capacity too low

The liquid end valves can be disturbed by vibrations.

- *Secure the metering pump so that no vibrations can occur.*



Capacity too low

If the valves of the liquid end are not vertical, they cannot close correctly.

- *Ensure that the suction and discharge valve are upright.*

8 Installation, hydraulic

Safety information



CAUTION!

Warning of feed chemical spraying around

An unsuitable feed chemical can damage the parts of the pump that come into contact with the chemical.

- Take into account the resistance of the wetted materials and the ProMinent Resistance List when selecting the feed chemical - see the ProMinent Product Catalogue or visit ProMinent.



CAUTION!

Warning of feed chemical spraying around

Pumps which are not fully installed hydraulically can eject feed chemicals from the outlet openings of the discharge valves as soon as they are connected to the mains.

- The pump must first be hydraulically installed and then electrically.
- In the event that you have failed to do so, press the *[STOP/START]* button or press the emergency-stop switch.



CAUTION!

Warning of feed chemical spraying around

Feed chemical may spray out of the hydraulic components if they are tampered with or opened due to pressure in the liquid end and adjacent parts of the system.

- Disconnect the pump from the mains power supply and ensure that it cannot be switched on again by unauthorised persons.
- Ensure that the system is at atmospheric pressure before commencing any work on hydraulic parts of the system.



CAUTION!

Danger from rupturing hydraulic components

Peak loads during the dosing stroke can cause the maximum permissible operating pressure of the system and pump to be exceeded.

- The discharge lines are to be properly designed.



CAUTION!

Danger of injury to personnel and material damage

The use of untested third party components can result in injury to personnel and material damage.

- Only fit parts to metering pumps that have been tested and recommended by ProMinent.

8.1 Installing hose lines

8.1.1 Installation with metering pumps without degassing

Safety information

**CAUTION!****Warning of feed chemical spraying around**

The lines can become loose or rupture if they are not installed correctly.

- Route all hose lines so they are free from mechanical stresses and kinks.
- Only use original hoses with the specified hose dimensions and wall thicknesses.
- Only use clamp rings and hose sleeves intended for the respective hose diameter to ensure the long service life of the connections.

**CAUTION!****Danger from rupturing hydraulic components**

Hydraulic components can rupture if the maximum permissible operating pressure of the hydraulic parts is exceeded.

- Adhere to the maximum permissible operating pressure of all hydraulic components - please refer to the product-specific operating instructions and system documentation.
- Never allow the metering pump to run against a closed shut-off device.
- Install a relief valve.

**CAUTION!****Hazardous feed chemicals can escape**

Hazardous feed chemical can leak out when using conventional degassing procedures with metering pumps.

- Install a degassing line with a return line into the supply tank.

**CAUTION!****Hazardous feed chemicals can escape**

Feed chemicals can escape outside in the event that the metering pump is removed from the installation.

- Install a shut-off valve on the discharge and suction side of the metering pump.

**CAUTION!****Uncontrolled flow of feed chemical**

Feed chemical may press through a stopped metering pump if there is back pressure.

- Use an injection valve or a vacuum breaker.



CAUTION!

Uncontrolled flow of feed chemical

The feed chemical can leak through the metering pump in an uncontrolled manner in the event of excessive priming pressure.

- Do not exceed the maximum permissible priming pressure for the metering pump.

INFORMATION: Align the lines so that the metering pump and the liquid end can simply be removed from the side if necessary.

Installing hose lines - NPT, PVT designs

1. ➤ Cut off the ends of the hoses at right angles.
2. ➤ Pull the union nut (2) and clamp ring (3) over the hose (1) - see Fig. 9.
3. ➤ Push the hose end (1) up to the stop over the nozzle (4) and widen, if necessary.

INFORMATION: Ensure that the O-ring or the flat seal (5) is sitting properly in the valve (6).

INFORMATION: Never re-use used PTFE seals. An installation sealed in this way is not leak-tight. This type of seal is permanently distorted when subjected to pressure.

4. ➤ Place the hose (1) with the nozzle (4) onto the valve (6).
5. ➤ Clamp the hose connector: tighten the union nut (2) while simultaneously pressing on the hose (1).
6. ➤ Re-tighten the hose connector: pull briefly on the hose line (1), which is fastened to the dosing head and then re-tighten the union nut (2).

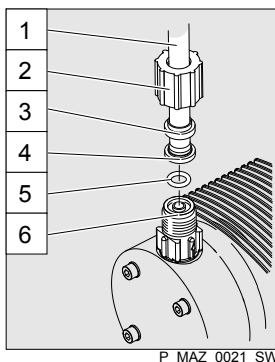

- 1 Hose
- 2 Union nut
- 3 Clamp ring
- 4 Nozzle
- 5 O-ring or flat seal
- 6 Valve

Fig. 9: NPT, PVT designs

Installing stainless steel pipes - SST design

1. ➤ Push the union nut (2) and clamp rings (3, 4) over the pipe (1) with approx. 10 mm overhang - see Fig. 10.
2. ➤ Insert the pipe (1) up to the stop in the valve (5) and then withdraw 1...2 mm.
3. ➤ Tighten the union nut (2).

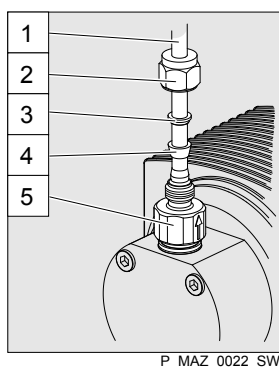

- 1 Pipe
- 2 Union nut
- 3 Rear clamp ring
- 4 Front clamp ring
- 5 Valve

Fig. 10: SST designs

Installing hose lines - SST design



CAUTION!

Warning of feed chemical spraying around

Connections can come loose in the event that hose lines are installed incorrectly on stainless steel valves.

- Only use PE or PTFE hose lines.
- In addition, insert a stainless steel support insert into the hose line.

8.1.2 Installation with metering pumps with degassing

Installation of the return line

All the installation and safety information for metering pumps without degassing also applies.

A return line is also connected in addition to the suction and pressure line.

1. ➤ Attach the hose line to the return hose sleeve or to the liquid end vent valve. PVC hose, soft, 6x4 mm is recommended.
2. ➤ Feed the free end of the return line into the supply tank.
3. ➤ Shorten the return line so that it is not immersed in the feed chemical in the supply tank.

8.2 Basic installation notes

Safety notes



CAUTION!

Danger resulting from rupturing hydraulic components

Hydraulic components can rupture if the maximum permissible operating pressure is exceeded.

- Never allow the metering pump to run against a closed shut-off device.
- With metering pumps without integral relief valve: Install a relief valve in the discharge line.



CAUTION!

Hazardous feed chemicals can escape

With hazardous feed chemicals: Hazardous feed chemical can leak out when using conventional bleeding procedures with metering pumps.

- Install a bleed line with a return into the storage tank.

→ Shorten the return line so that it does not dip into the feed chemical in the storage tank.

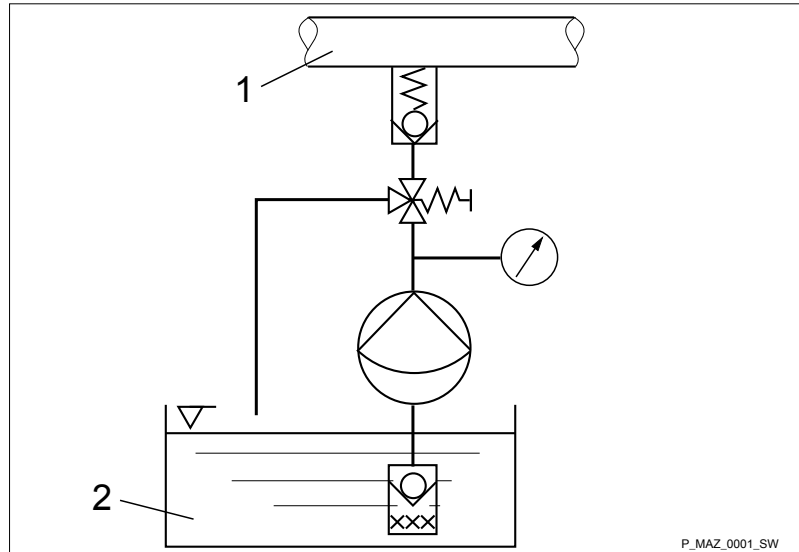

Fig. 11: Standard installation

- 1 Main line
- 2 Storage tank

Legend for hydraulic diagram

Symbol	Explanation	Symbol	Explanation
	Metering pump		Foot valve with filter meshes
	Injection valve		Level switch
	Multifunctional valve		Manometer

9 Installation, electrical

**WARNING!****Danger of electric shock**

A mains voltage may exist inside the device.

- Before any work, disconnect the device's mains cable from the mains.

**WARNING!****Risk of electric shock**

In the event of an electrical accident, the pump must be quickly disconnected from the mains.

- Install an emergency cut-off switch in the pump power supply line or
- Integrate the pump in the emergency cut-off management of the system and inform personnel of the isolating option.

**WARNING!****Danger of electric shock**

Incompletely installed electrical options can allow moisture into the inside of the housing.

- Fit appropriate modules into the slot on the front of the pump or use the original blank cover to seal it in a leak-tight manner.

**WARNING!****Danger of electric shock**

Supply voltage may be present inside the pump housing.

- Safely and quickly disconnect the pump from the mains/power supply if the pump housing has been damaged.
Only return the pump to operation after an authorised repair.

**CAUTION!****Risk of short circuiting caused by moist pins**

No moisture must reach the pins of the PROFIBUS® jack.

- A suitable PROFIBUS® plug or protective cap must be screwed onto the PROFIBUS® jack.



CAUTION!

Material damage possible due to power surges

Should the pump be connected to the mains power supply in parallel to inductive consumers (such as solenoid valves, motors), inductive power surges can damage the control when it is switched off.

- Provide the pump with its own contacts (Phase) and supply with voltage via a contactor relay or relay.
- Should this not be possible, then switch a varistor (part no. 710912) or an RC gate (0.22 μ F/220 Ω , part no. 710802) in parallel.



CAUTION!

Bonding of the contacts of your switching relay

The high starting current can cause the contacts of the on-site switching relay to bond together if the mains voltage switches a solenoid metering pump on and off in a process.

- Use the switching options offered by the external socket to control the pump (functions: Pause, Auxiliary frequency or Operating modes: Contact, Batch, Analogue).
- Use a starting current limiter if it is impossible to avoid switching the pump on and off via a relay.

→ Install the pump in line with best working practice and in accordance with the operating instructions and applicable regulations.

9.1 Supply voltage connector - power supply



WARNING!

Unexpected start-up is possible

The pump can start pumping and consequently feed chemical may escape as soon as the pump is connected to the mains/power supply.

- Avoid the escape of feed chemical.
- If you have not done so, immediately press *[STOP/START]* or disconnect the pump from the mains voltage e.g. using an Emergency Stop switch.
- Refer to the material safety data sheet for your feed chemical.



CAUTION!

If the pump is integrated into a system: Design the system so that potential hazardous situations are avoided by pumps starting up automatically subsequent to unintended power interruptions.

Connect the pump to the power supply using the mains cable.

9.2 HMI operating unit

Connect the HMI to the CAN socket above the LEDs of the pump base if the pump is operated with HMI.

If the pump is operated without HMI, then plug the sealing cap supplied into the CAN socket above the LEDs of the pump base.



CAUTION!

Risk of short circuiting

A short circuit may occur in the pump if liquid penetrates into the CAN socket.

- Always plug a CAN plug or the sealing cap supplied into the CAN socket.



CAUTION!

Danger of malfunction

Incorrect operation via the CAN bus will lead to malfunctions.

- Do not connect any other control (e.g. DXCa) to the CAN socket when operating with HMI connected.

9.3 Description of the terminals

9.3.1 "Config I/O" terminal

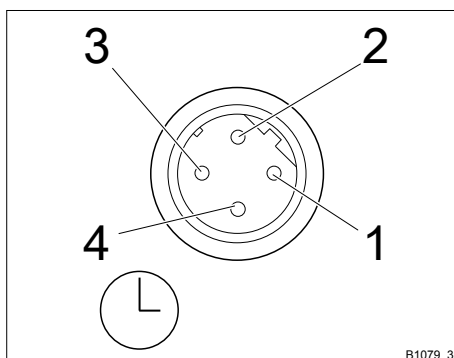

There is an option to transmit the signals of 3 potential-free contacts as inputs I: to the pump via the "Config I/O" terminal or issue contact signals as Outputs O:.

Fig. 12: "Config I/O" terminal, pin assignment

Tab. 3: Pin assignment

Pin	Assignment	4-wire cable
1	Config I/O 1	brown
2	Config I/O 2	white
3	Config I/O 3	blue
4	GND	black

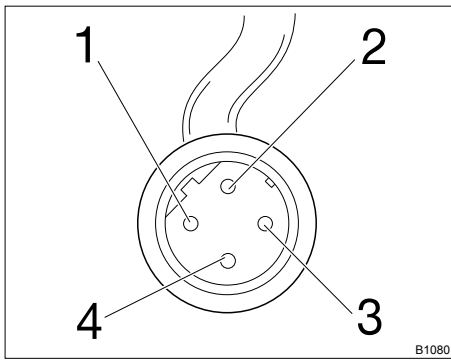

Fig. 13: Plug to "Config I/O" terminal, pin assignment

Configured as an input

Parameter	Value
Voltage with open contacts	5 V
Input resistance	10 kΩ
Max. pulse frequency	50 pulses/s
Min. pulse duration	10 ms

Tab. 4: Control via:

Switching element	Specification
Potential-free contact	Load: 0.5 mA at 5 V
Semiconductor switch	Residual voltage < 2 V

Configured as an output

Parameter	Value
Max. pulse frequency	50 pulses/s
Min. pulse duration	10 ms

Tab. 5: .

Switching element	Specification
NPN output (Open Drain)	30 V max. voltage and 300 mA max. current load per pin

No protection provided for inductive loads.

- Provide a free-running diode when controlling a relay.

9.3.2 "External control" terminal

The "External control" terminal is a 5-pin panel terminal. It is compatible with 2- and 4-pin cables.

Only use a 5-pin cable with the "Auxiliary capacity" / "Auxiliary frequency" functions.

Only use a 4-pin or a 5-pin cable with the "mA input" function.

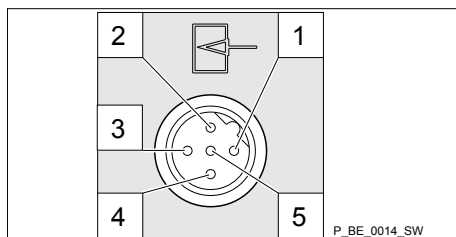

Fig. 14: Assignment on the pump

Electrical interface for pin 1 "Pause" - pin 2 "External contact" - pin 5 "Auxiliary capacity / Auxiliary frequency"

Data	Value	Unit
Voltage with open contacts	5	V
Input resistance	10	kΩ
Max. pulse frequency	25	pulse/s
Min. pulse duration	20	ms

Control via:

- potential-free contact (load: 0.5 mA at 5 V) or
- semiconductor switch (residual voltage < 0.7 V)

Electrical interface for pin 3 "mA input" (with identity code characteristic "Control version": 2 and 3)¹

Data	Value	Unit
Input load, approx.	120	Ω

¹ At 0.0 .. 0.4 mA (4.4 mA) the metering pump performs its first metering stroke and at 19.6 ... 20.0 mA the pump reaches maximum frequency.

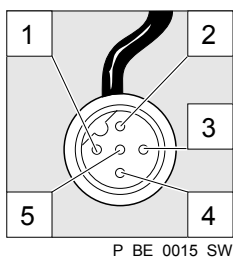

Fig. 15: Assignment on the cable

Pin	Function	5-wire cable	2-wire cable
1	Pause	brown	bridged at pin 4
2	External contact	white	brown
3	mA input*	blue	-
4	Earth GND	black	white
5	Auxiliary capacity / Auxiliary frequency	grey	-

* with identity code characteristic "Control version": 3



Refer to the functional description for the sequence of functions and operating modes.

"Pause" function

The pump works if:

- pin 1 and pin 4 are connected to each other and the cable is connected.
- no cable is connected.

The pump does not work if:

- pin 1 and pin 4 are open and the cable is connected.



Acknowledge fault with 'Pause'

Certain errors requiring acknowledgement can also be acknowledged using 'Pause' instead of using the [P] key. These are errors like: 'Flow', 'Air lock', 'p-' (as soon as the conditions are in order).

"External contact" operating mode

The pump performs one or more strokes if:

- Pin 2 and pin 4 are connected to each other for at least 20 ms. At the same time, pin 1 and pin 4 must also be connected to each other.

"Analog" operating mode

The pump capacity and/or stroke rate can be controlled by a current signal. The current signal is connected between pin 3 and pin 4.

Pin 1 and pin 4 must also be connected.

"Auxiliary capacity" / "Auxiliary frequency" operating mode

The pump works at a pre-set capacity / stroke rate if:

- Pin 5 and pin 4 are connected to each other. At the same time, pin 1 and pin 4 must also be connected to each other. The auxiliary capacity / auxiliary frequency is factory-preset to maximum capacity / stroke rate.

9.3.3 "Level switch" terminal

There is a connecting option for a 2-stage level switch with pre-warning and limit stop or a suction lance with continuous level measurement.

9.3.3.1 Suction lance with 2-stage level switch

Electrical interface

Data	Value	Unit
Voltage with open contacts	5	V
Input resistance	10	kΩ

Control via:

- potential-free contact (load: 0.5 mA at 5 V) or
- semiconductor switch (residual voltage < 0.7 V)

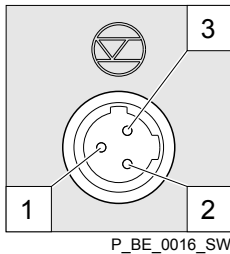

Fig. 16: Assignment on the pump

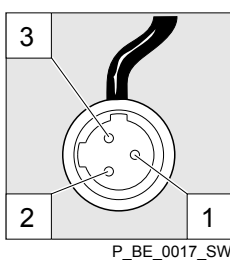

Fig. 17: Assignment on the cable

Pin	Function	3-wire cable
1	Earth GND	black
2	Minimum pre-warning	blue
3	Minimum limit stop	brown

9.3.3.2 Suction lance with continuous level measurement

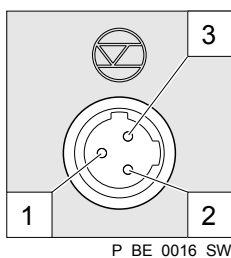

Fig. 18: Assignment on the pump

Electrical interface

Pin	Designation	Function
3	5 V supply TX to sensor	5 V (4.85 V...5.25 V DC) feed to the sensor and TX communication interface (from the point of view of the pump).
1	GND	Reference potential
2	RX from sensor	RX communication interface (from the point of view of the pump)

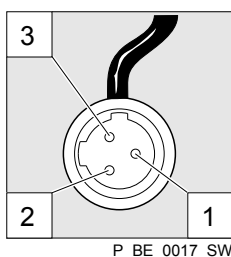

Fig. 19: Assignment on the cable

Pin	Designation
1	5 V supply Sensor + RX
2	GND
3	Sensor TX

9.3.4 "Metering monitor" terminal

There is a connecting option for a metering monitor.

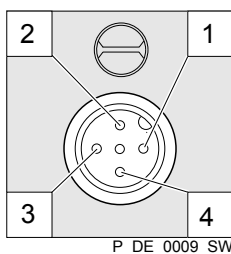

Fig. 20: Assignment on the pump

Electrical interface

Data	Value	Unit
Voltage with open contacts	5	V
Input resistance	10	kΩ

Control via:

- potential-free contact (load: 0.5 mA at 5 V) or

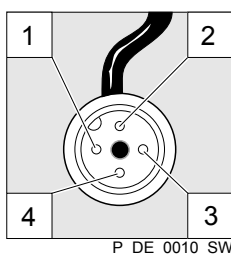

Fig. 21: Assignment on the cable

Pin	Function	4-wire cable
1	Power supply (5 V)	brown
2	Coding	white
3	Feedback	blue
4	Earth GND	black

9.3.5 "Diaphragm rupture indicator" terminal

There is a connecting options for a diaphragm rupture indicator.

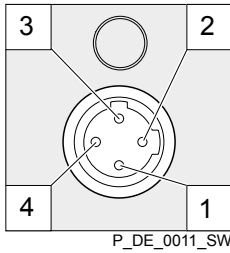

Fig. 22: Assignment on the pump

Electrical interface

Specification	Value
Supply voltage, approx.:	+5 V, can be loaded to 20 mA (current limitation 150 mA)
Power consumption:	min. 10 mA, max. 20 mA (sensor presence detection)
Sensor signal:	potential-free contact (load: 0.5 mA at +5 V) or semiconductor switch (residual voltage < 0.3 V)

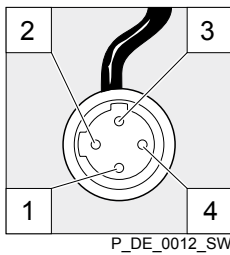

Fig. 23: Assignment on the cable

Pin	Function	4-wire cable
1	Power supply (5 V)	brown
2	not assigned	white
3	Sensor signal	blue
4	Earth GND	black

9.3.6 Relays

9.3.6.1 Relay functions

Tab. 6: gamma/ XL GXLa

Identity code	Designation	Type	Maximum voltage	Maximum current	Operational life-time Min. switching operations
0	no relay	-	-	-	-
1	Fault indicating relay, N/C	Changeover contact	230 V AC	6 A	50 000
4	Fault indicating relay, N/C	N/C	24 V DC	1 A	50 000
	Pacing relay, normally open	N/O	24 V DC	100 mA	unlimited
C	4-20 mA current output	-	-	-	-
	Fault indicating relay, N/C	N/C	24 V DC	100 mA	unlimited
F	Automatic bleeding	Changeover contact	230 V AC	6 A	50 000
G	Automatic bleeding	N/O	24 V DC	1 A	50 000
	Fault indicating relay, N/C	N/C	24 V DC	100 mA	unlimited

Relay type

You can reprogram the relays to these types:

Menu setting	Effect
Timer	The relay switches when requested by the timer.
Fault	The relay switches in the event of an error message (red LED*).
Warning	The relay switches in the event of a warning message (yellow LED*).
Warning + error (fault indicating relay)	The relay switches in the event of a warning message (yellow LED*) or an error message (red LED*).
Warning + error + stop	The relay switches in the event of a warning message (yellow LED*), when stopped by <i>[Start/Stop]</i> or in the event of a fault message (red LED*).
Pump active	The relay switches as soon as the pump is in standby and not stopped and not in a state like <i>'Pause'</i> or if an error is pending. In the opposite case, the relay switches back again.
Stroke rate** (pacing relay)	The relay switches with every stroke.
Cycle quantity** (pacing relay)	The relay always switches when the set cycle quantity has been reached.
Metering / Batch	The relay changes its state as soon as a batch has been processed.
Degassing***	The relay opens an optionally installed bleed valve as soon as the control activates it.

* see the "Troubleshooting" chapter

** only use *'Relay 2'* for this relay type (semiconductor relay).

*** only use *'Relay 1'* for this relay type.

Relay polarity

You can set here how a relay is to switch.

Menu setting	Effect
Break contact N/C	The relay is closed in normal mode and opens with a triggering event. (N/C)
Make contact N/O	The relay is open in normal mode and closes with a triggering event. (N/O)

9.3.6.2 "Fault indicating relay" output (identity code 1)

A fault indicating relay can be ordered as an option - refer to ordering information in the appendix. It is used to emit a signal when there is a fault with the pump and for the "Liquid level low, 1st stage" warning message and "Liquid level low 2nd stage" fault message.

The fault indicating relay can be retrofitted and is operational once attached to the relay board - refer to "Retrofitting relays" supplementary operating instructions.

The behaviour is factory-programmed. If another switching function is wished, the pump can be reprogrammed in the *'Relay'* menu.

The relay can be retrofitted and is operational once it has been plugged into the relay board.

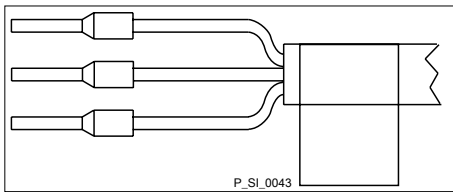

Fig. 24: Assignment on the cable

Identity code 1

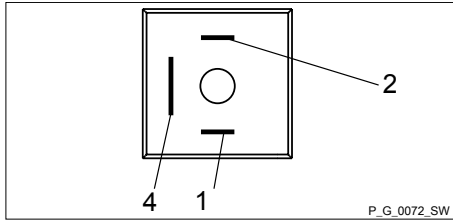

Fig. 25: Assignment on the pump

To pin	VDE cable	Contact	CSA cable
1	white	N/O (normally open)	white
2	Green	N/C (normally closed)	red
4	brown	C (common)	black

9.3.6.3 Output for other relays (identity code 4)

A fault indicating and a pacing relay can be ordered as options - refer to ordering information in the appendix. The pacing output is electrically isolated by means of an optocoupler with a semiconductor switch. The second switch is a relay (also electrically isolated).

The behaviour is factory-programmed. If another switching function is wished, the pump can be reprogrammed in the 'Relay' menu.

The fault indicating/pacing relay can be retrofitted and is operational once attached to the relay board - refer to the "Retrofitting relays" supplementary instructions.

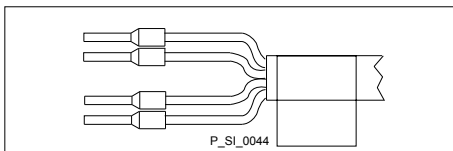

Fig. 26: Assignment on the cable

Electrical interface

for semiconductor switch pacing relay:

Data	Value	Unit
Max. residual voltage at $I_{off\ max} = 1\ \mu A$	0.4	V
Pacing pulse duration, approx.	100	ms

Identity code 4

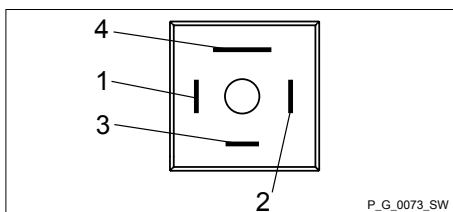

Fig. 27: Assignment on the pump

To pin	VDE cable	Contact	Relay
1	yellow	N/O (normally open)	Relay 1
4	Green	C (common)	Relay 1
3	white	N/O (normally open)	Relay 2
2	brown	C (common)	Relay 2

9.3.6.4 "Current output plus relay" output (identity code C)

A relay combined with a current output can be ordered as an option. The relay either switches as a fault indicating relay in the event of a fault on the pump and with "Liquid level low 1st stage" warning message and "Liquid level low 2nd stage" fault messages or is used as a pacing relay.

The behaviour is factory-programmed. If another switching function is wished, the pump can be reprogrammed in the 'Relay' menu.

The variable to be signalled for the current output can be selected in the 'ANALOGUE OUTPUT' menu.

The current output plus relay can be retrofitted and operates once it is plugged into the board.

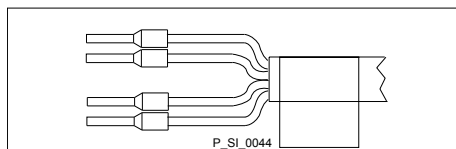

Fig. 28: Assignment on the cable

Electrical interface
for current output

Data	Value	Unit
Open circuit voltage:	8	V
Current range:	4 ... 20	mA
Ripple, max.:	80	μ A ss
Load, max.:	250	Ω

for semiconductor switch ("relay"):

Data	Value	Unit
Max. residual voltage at $I_{off\ max} = 1\ \mu$ A	0.4	V
Pacing pulse duration, approx.	100	ms

Identity code c

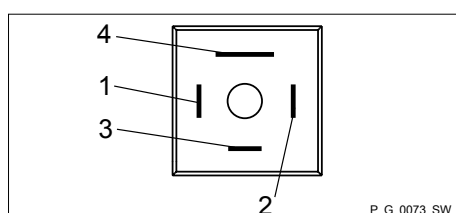

Fig. 29: Assignment on the pump

To pin	VDE cable	Contact	Relay
1	yellow	"+"	Current output
4	Green	"-"	Current output
3	white	N/C (normally closed) or N/O (normally open)	Relay
2	brown	C (common)	Relay

10 Basic set-up principles



- Please also refer to all the overviews covering "Operating/set-up overview" and "Operating menu for gamma/ XL, complete" in the appendix and the "Overview of equipment and control elements" and "Control elements" chapters.
- The pump exits the menu and returns to a continuous display if [Menu] is pressed or no key is pressed for 60 seconds.

10.1 Basic principles for setting up the control



Fig. 30: Please read

Fig. 31 shows using the "Language" example how to set up something - in turn:

- Sequence of displays
- The path derived from this
- The path as presented in the operating instructions

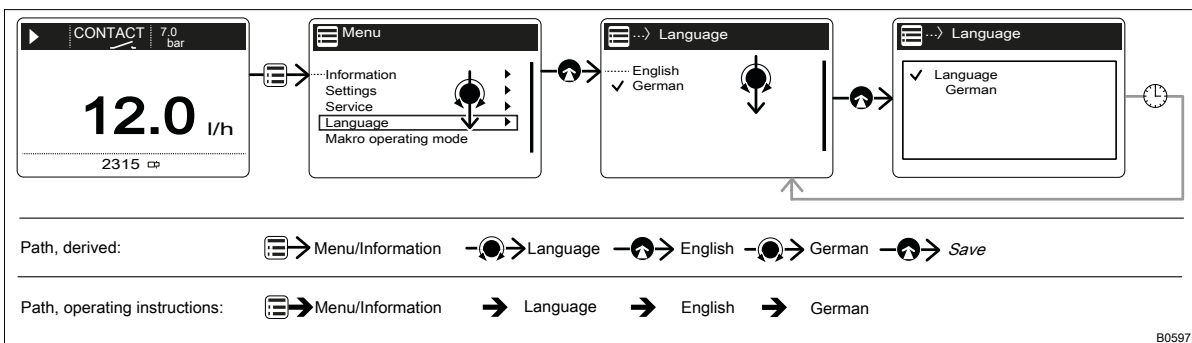

Fig. 31: "Setting up the language": As an example of set-up and path displays

Tab. 7: Legend:

Symbol	Explanation
	Press [Menu]
	Turn the [Clickwheel]
	Press the [Clickwheel]

"Setting up the language" in detail

1. To access the 'Menu': press the [Menu] key.
⇒ The cursor immediately points to 'Information'.
2. To switch from 'Information' to 'Language': turn the [Clickwheel].
3. To return to the 'Language' menu: press the [Clickwheel].
⇒ The cursor points to a language.
4. To switch to 'Deutsch': turn the [Clickwheel].
5. To save: press the [Clickwheel].
⇒ The software shows a display by way of confirmation.
After 2 seconds, it returns to the higher-level 'Menu'.

6. ➔ To complete the setting: press  [Menu].

Alternatively: wait 60 seconds or exit the 'Menu' via the  [Menu] key or using 'End'.

Confirming an entry

➔ Briefly press the [Clickwheel].

⇒ The software switches to the next menu point or back to the menu and saves the entry.

Exiting a menu option without confirming it

➔ Press  [Back].

⇒ The software switches to the next menu point or back to the menu without saving anything.

Returning to a continuous display

➔ Press  [Menu].

⇒ The software cancels the entry and switches to a continuous display without saving anything.

Changing adjustable variables

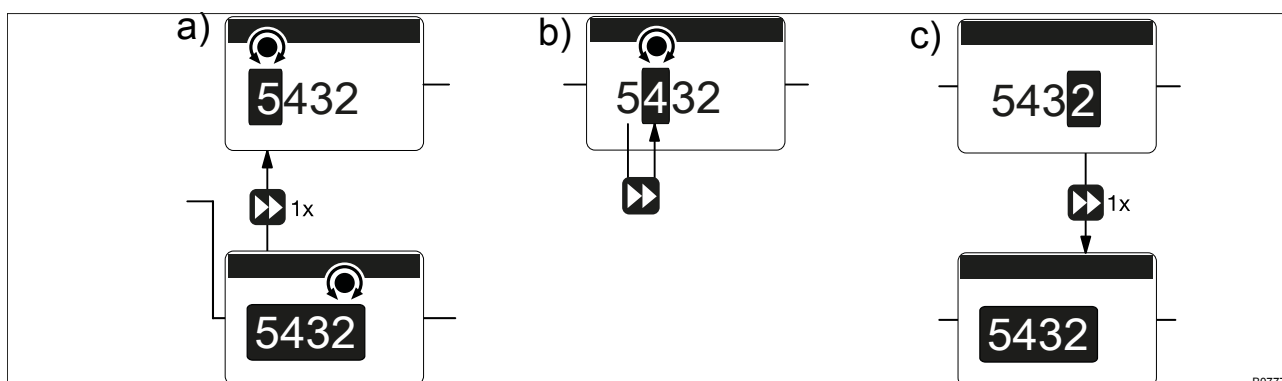



Fig. 32: a) Changing from one figure to its initial figures; b) Changing the figure; c) Returning from the last figure to the (complete) figure (to correct a wrong figure, for example).

Changing a (complete) number

➔ Turn the [Clickwheel].

⇒ The value of the figure highlighted is raised or lowered.

Changing figures

1. ➔ To adjust the value of a figure digit-by-digit, press  [Priming].

⇒ The first figure is highlighted - see Figure above, point a)

2. ➔ To adjust the value of a figure, turn the [Clickwheel].

3. ➔ To move to the next figure, press  [Priming] - see above Figure, point b).

- ▶ To run through the figures again, if necessary (possibly because of an incorrect figure), when you get to the last figure press  [Priming] again - see above Figure, point c).
⇒ Now you can start from the beginning again.

Confirming adjustable variables

- ▶ Press the [Clickwheel] 1x.
⇒ The software saves the entry.

10.2 Checking adjustable variables

Continuous displays

Before adjusting the pump, you can check the current settings of the adjustable variables:

- ▶ Simply turn the [Clickwheel] if the pump is showing a continuous display.
⇒ Each time the [Clickwheel] engages when you turn it, you will see a different continuous display.



The number of continuous displays depends on the identity code, the selected operating mode and the connected additional devices – see overview of "Continuous displays" in the appendix.

Secondary displays

The lowest line of a continuous display shows different information (which cannot be adjusted in the secondary display) - see "Continuous displays and secondary displays" overview in the appendix.

You can access secondary displays via any continuous display as follows:

- ▶ Press the [Clickwheel] for 3 seconds.
⇒ A frame appears around the secondary display.
- ▶ Providing there is a frame, you will see a different secondary display each time the [Clickwheel] engages when turned.
When you reach the secondary display you wish, leave the [Clickwheel] and wait briefly.

10.3 Changing to Setting mode

In a continuous display, if you press  'Menu', the pump in Setting mode changes to 'Menu'. For more information refer to the following chapter entitled "Set up / Menu".

If under 'Access protect.' only 'Menu' or 'All' has been set up (top right  lock symbol), then after pressing the [Clickwheel], first enter the 'Password'.

11 Set up / 'Menu'



- Refer to the overviews covering "Operating/set up overview" and "Operating menu gamma/XL, complete" in the appendix and in the "Overview of equipment" - "Control elements" chapters by way of supplementary information.
- The pump exits the menu and returns to a continuous display if  [Menu] is pressed or if no key is pressed for 60 seconds.

The 'Menu' is sub-divided as follows:

- 1 - 'Information'
- 2 - 'Settings'
- 3 - 'Timer'
- 4 - 'Service'
- 5 - 'Language'

11.1 'Information'

 → 'Menu / Information → ...'

The 'Information' provides information on your pump and certain parameters and counters. The number and type can depend on the pump settings.

11.2 'Settings'

 → 'Menu / Information → Settings → ...'

The 'Settings' menu generally includes these setting menus:

- 1 - 'Operating mode'
- 2 - 'Automatic'
- 3 - 'Stroke length'
- 4 - 'Metering'
- 5 - 'Concentration'
- 6 - 'Calibrate'
- 7 - 'System'
- 8 - 'Inputs/outputs'
- 9 - 'Config I/O'
- 10 - 'Degassing'
- 11 - 'Priming time'
- 12 - 'Set time'
- 13 - 'Date'

11.2.1 'Operating mode'

 → 'Menu / Information' → Settings → Operating mode → ...'

11.2.1.1 'Manual'

 → 'Menu / Information' → Settings → Operating mode
→ Manual'

'Manual' operating mode lets you operate the pump manually.

The capacity and/or stroke rate and stroke length can be set in the continuous displays in this operating mode.

11.2.1.2 'Contact'

 → 'Menu / Information' → Settings → Operating mode
→ Contact → ...'

'Contact' operating mode allows you to trigger individual strokes or a series of strokes.

You can trigger the strokes via a pulse sent via the "External control" terminal.

The purpose of this operating mode is to convert the incoming pulses into strokes with a step-down (fractions) or small step-up or also 1:1.



CAUTION!

The pump maintains the stroke rate when changing over from 'Manual' operating mode to 'Contact' operating mode.



The maximum stroke rate can be set in 'Contact' operating mode. It should normally be set to 12,000 strokes/hour.

Contact - adaptive

If the gaps between the pulses (e.g. from a contact water meter) slowly change, you can set the pump to 'Adaptive → On' - the pump will then meter more evenly.

Memory - Pulses not yet processed

You can also activate the 'Memory' function extension ("memory" identifier). When 'Memory' is activated, the pump adds up the remaining strokes, which could not be processed, up to the maximum capacity of the stroke memory of 999,999 strokes. If this maximum capacity is exceeded, the pump goes into fault mode.



CAUTION!

- Only with 'Memory' - 'off': If you press  [STOP/START] or empty the contact memory ('Menu / Information → Service → Clear counters) or the "Pause" function is activated, the 'Memory' is cleared.

('Automatic' 'Off') factor

The number of strokes per pulse depends on the factor which you can input. By using a factor you can multiply incoming pulses by a factor between 1.01 to 99.99 or reduce them by a factor of 0.01 to 0.99:

Number of strokes executed = factor x number of incoming pulses

Table of examples

	Factor	Pulse (sequence)	Number of strokes (sequence)
Step-up*			
	1	1	1
	2	1	2
	25	1	25
	99.99	1	99.99
	1.50	1	1.50 (1 / 2)
	1.25	1	1.25 (1 / 1 / 1 / 2)
Step-down**			
	1	1	1
	0.50	2	1
	0.10	10	1
	0.01	100	1
	0.25	4	1
	0.40	2.5 (3 / 2)	(1 / 1)
	0.75	1.33 (2 / 1 / 1)	(1 / 1 / 1)

*Tab. 8: * Explanation of step-up*

With a factor of 1	... 1 stroke is executed per 1 pulse
With a factor of 2	... 2 strokes are executed per 1 pulse
With a factor of 25	... 25 strokes are executed per 1 pulse

*Tab. 9: ** Explanation of step-down*

With a factor of 1	... 1 stroke is executed per 1 pulse.
With a factor of 0.5	...1 stroke is executed after 2 pulses.
With a factor of 0.1	...1 stroke is executed after 10 pulses.
With a factor of 0.75	...1 stroke is executed once after 2 pulses, then 1 stroke is executed twice after 1 pulse, and then again 1 stroke after 2 pulses etc.



If a remainder is obtained when dividing by the factor, then the unit adds the remainders together. As soon as this sum reaches or exceeds "1", the pump executes an additional stroke. Therefore on average during the metering operation, the resultant number of strokes precisely matches the factor.

Metering volume ('Automatic' 'On')

The same applies to the 'Metering volume' as to the 'Factor'.

Contact water meter

Using "Pulse control" you can ideally adapt the pump to the relevant process, for example in conjunction with contact water meters.

11.2.1.3 'Batch'

 → 'Menu / Information' → Settings → Operating mode → Batch → ...'

The 'Batch' operating mode enables you to pre-select large metering volumes.

You can only select whole numbers but no fractions as the number of strokes (figures 1 to 99,999).

You can trigger the strokes using the [Clickwheel] if you have already switched to the 'Push' continuous display. You can also trigger them via a pulse using the "External control" terminal.



The stroke rate can be set in 'Batch' operating mode. It should normally be set to 12,000 strokes/hour.



The maximum batch time that can be set is 10 000 s.



The maximum possible batch in automatic mode is the feed rate (in litres or gallons) that the metering pump can meter in 10,000 seconds at maximum capacity.

Memory - remaining strokes not yet processed

You can also activate the 'Memory' function extension ("memory" identifier). When 'Memory' is activated, the pump adds up the remaining strokes, which could not be processed, up to the maximum capacity of the stroke memory of 999,999 strokes. If this maximum capacity is exceeded, the pump goes into fault mode.

**CAUTION!**

- The pump maintains its stroke rate when changing over from 'Manual' operating mode to 'Batch' operating mode.
- When you press  [STOP/START] or the "Pause" function is activated, the 'Memory' is cleared.



In operation, the batch size can be changed more easily by using the "Batch size" continuous display.

11.2.1.4 'Analog' (option)

 → 'Menu / Information → Settings → Operating mode → Analog → ...'

The secondary display "Signal current" indicates the incoming current.

You can select 5 types of current signal processing:

- '0 - 20 mA'
- '4 - 20 mA'
- 'Linear curve'
- 'Lower side band'
- 'Upper side band'

'0 - 20 mA'

At 0 mA the pump is stationary –

At 20 mA the pump works at maximum stroke rate.

'4 - 20 mA'

At 4 mA the pump is stationary –

At 20 mA the pump works at maximum stroke rate.

With current signals of less than 3.8 mA, an error message appears and the pump stops (e.g. if a cable has broken).

'Linear curve'

The "Linear curve" symbol appears on the LCD screen. You can enter any pump stroke rate behaviour proportional to the current signal. For this purpose, enter any two points P1 (I1, F1) and P2 (I2, F2) (F1 is the stroke rate at which the pump is to operate at current I1, F2 is the stroke rate at which the pump is to operate at current I2...); this defines a straight line and thus the behaviour is specified:

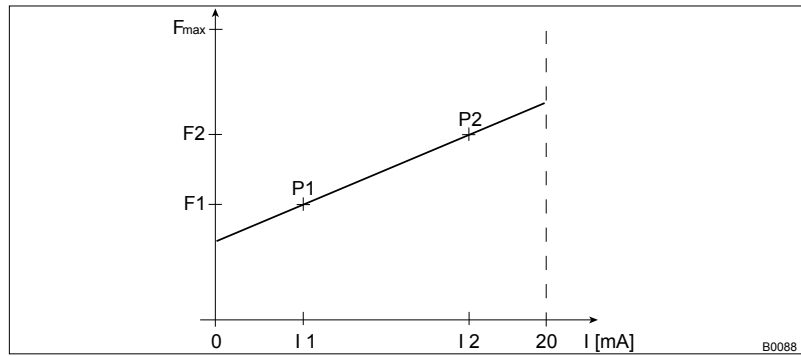

Fig. 33: Frequency-current diagram for "Linear curve"



Plot a diagram similar to the one above – with values for (I_1, F_1) and (I_2, F_2) – so that you can set the pump as desired!



The smallest processable difference between I_1 and I_2 is 4 mA ($\|I_1 - I_2\| \geq 4$ mA).

Error processing

In the 'Error message' menu item, you can activate error processing for these types of processing.

'Lower side band'

Using this type of processing, you can control a metering pump using the current signal as shown in the diagram below.

However, you can also control two metering pumps for different feed chemicals via a current signal (e.g. one acid pump and one alkali pump using the signal of a pH sensor). To do this, connect the pumps electrically in series.

Error processing

In the 'Error message' menu item, you can activate error processing for these types of processing.

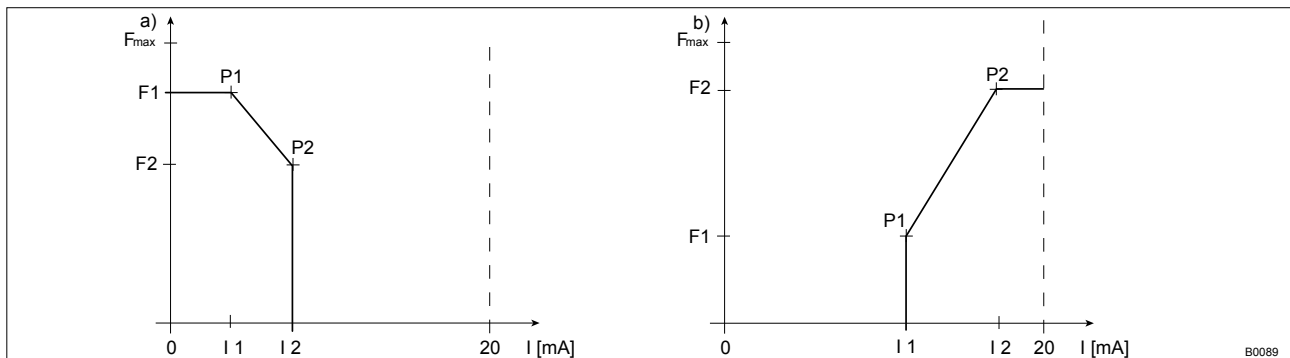



Fig. 34: Frequency-current diagram for a) Lower side band, b) Upper side band

'Upper side band'

Using this processing type, you can control a metering pump using the current signal as shown in the diagram above.

Everything functions according to the 'Lower side band' type of processing.

11.2.2 'Automatic'

 → 'Menu / Information → Settings → Automatic → ...'

The 'Automatic' menu lets you set whether the unit is to meter automatically or conventionally.

'Automatic' - 'on' lets you set direct values, such as capacity, metering volume or dosing time, instead of stroke length and stroke rate. Other selection points then appear in the operating menu - refer to the chapter "Operating menu gamma/ XL, complete" (in the appendix) for the selection points highlighted with a "*1".

In 'Automatic' - 'on' metering mode, the gamma/ X specifies the stroke length and the stroke rate according to the conditions determined in order to meter the set capacity.



'Automatic' - 'on' and 'Automatic' - 'off' metering modes are completely independent of each other. That is to say that 'Automatic' - 'off' metering mode does not carry over settings from 'Automatic' - 'on'.

Tab. 10: Setting ranges

	'Automatic' - 'on'	'Automatic' - 'off'
Manual, continuous	1:2,000	1:2,000
Manual, discontinuous	1:40,000	1:40,000

11.2.3 'Stroke length'

 → 'Menu / Information → Settings → Stroke length → ...'

The menu does not appear with 'Automatic' 'on'!

In the 'Stroke length' menu, you can enter the stroke length manually.



In operation, the stroke length can be changed more easily via the "Stroke length" continuous display:

- Turn the [Clickwheel] to return to the "Stroke length" continuous display.
- Press the [Clickwheel] and then turn it to set the stroke length.
- Press the [Clickwheel] to save the stroke length.

11.2.4 Metering

☰ → 'Menu / Information → Settings → Metering → ...'

11.2.4.1 'Discharge stroke'

☰ → 'Menu / Information → Settings → Metering
→ Discharge stroke → ...'

In the 'Settings' - 'Discharge stroke' sub-menu, you can precisely match the pump metering flow over time to the requirements of the particular application.

This ensures that users can set the optimum discharge stroke for their application, as required:

Pos.*	Discharge stroke	Application
A.	'optimum'	For maximum precision when metering and the very best results with internal pressure measurement and special functions.
B.	'fast'	For a fast discharge stroke.
C.	'very fast'	For a super-fast discharge stroke.
D.	'sine mode'	The duration of the discharge stroke is dependent on the stroke rate for a long, sine-shaped discharge stroke.
E.	'continuous'	For a continuous discharge stroke e.g. for bottling processes. The duration of the discharge stroke is dependent on the stroke rate.
F.	'DFMa'	For optimum operation with a flow meter DulcoFlow® DFMa.

* see following drawing.

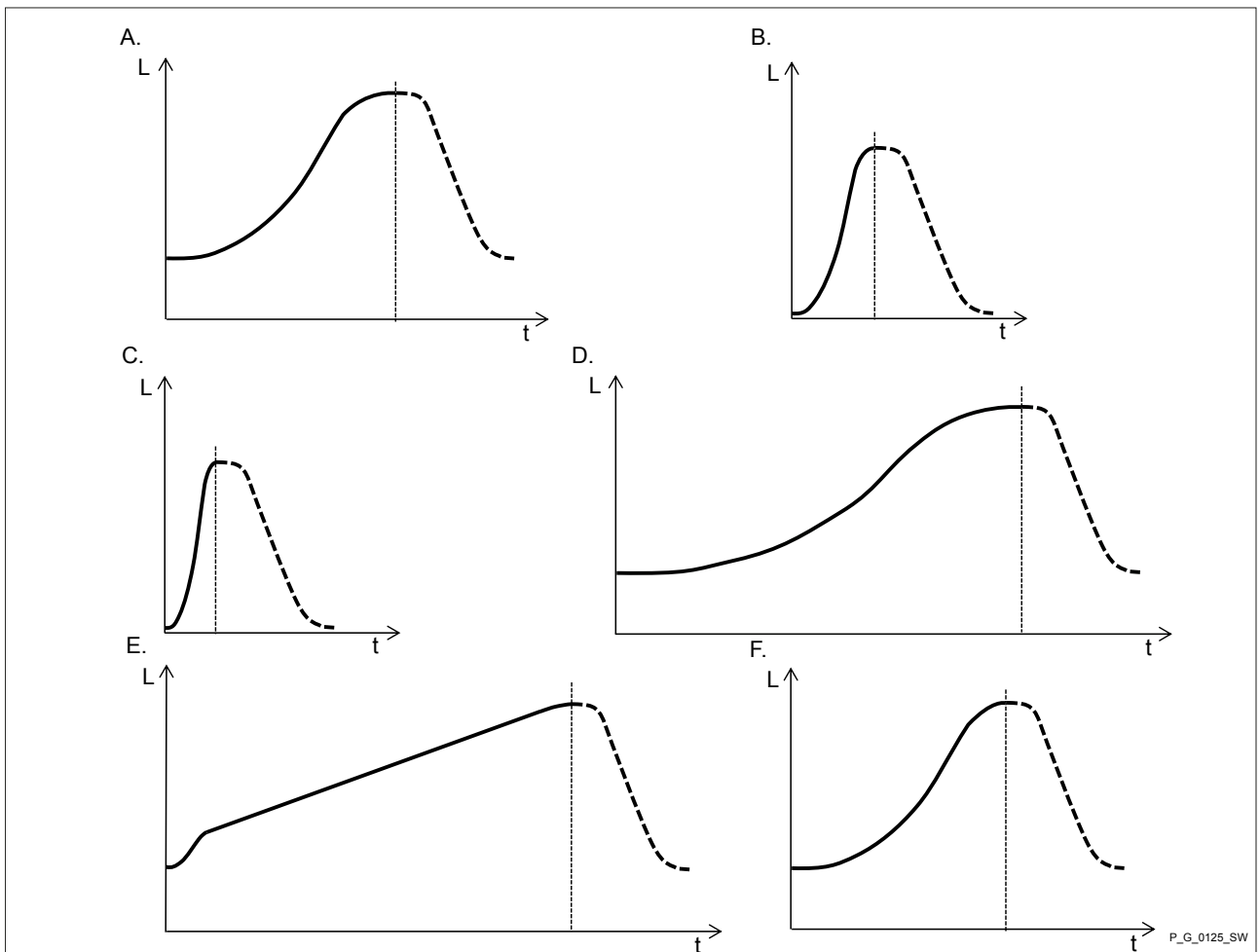

Fig. 35: Discharge stroke metering profiles with stroke L and time t (suction stroke shown as a dotted line)

11.2.4.2 'Suction stroke'

☰ → 'Menu / Information → Settings → Metering
→ Suction stroke → ...'

It is possible to selectively also slow the **suction stroke** with all these metering profiles for the discharge stroke - see . In this way, it is possible to prevent the main cause of inaccurate metering with high viscosity feed chemicals, namely the incomplete filling of the liquid end. With gaseous feed chemicals, the slow suction stroke prevents cavitation and consequently increases dosing precision.

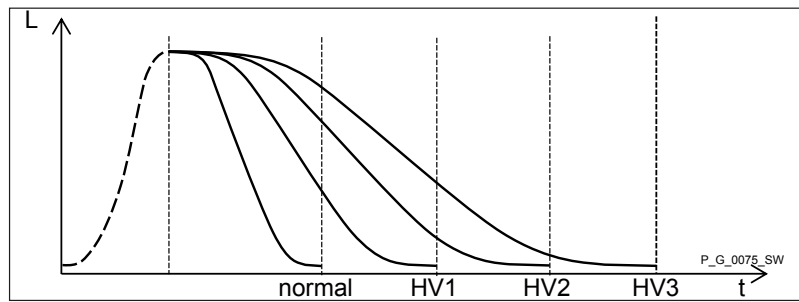

Fig. 36: Suction stroke metering profiles with stroke L and time t

- Normal Normal suction stroke
- HV1 Suction stroke for viscous feed chemical
- HV2 Suction stroke for average viscosity feed chemical
- HV3 Suction stroke for high-viscosity feed chemical



– Slowing down the suction stroke leads to a lower stroke rate and thus to a lower capacity.

'Suction stroke' setting	Maximum stroke rate Strokes/min.
Normal	200
HV1	160
HV2	120
HV3	80

11.2.4.3 'Pressure rating'

☰ → 'Menu / Information → Settings → Metering → Pressure rating → ...'

You can use the programmable 'Pressure rating' function to reduce the nominal pressure of the pump, thereby minimising the risk of lines rupturing.

The switch-off pressure of the permanently active overpressure monitoring falls at the same time as the pressure rating - see .

Tab. 11: Nominal pressures depending on the size of the liquid ends and the pressure ratings

Pressure rating /	4	7	10	16	25
Size of liquid end					
2508	X	X	X	-	X
1608	X	X	X	X	-
1612	X	X	X	X	-

Pressure rating /	4	7	10	16	25
Size of liquid end					
1020	X	X	X	-	-
0730	X	X	-	-	-
0450	X	-	-	-	-

Switch-off pressure

Switch-off pressure: Pressure above which the unit is switched off for the medium term in the event of excess pressure = Pressure rating plus 10 ... 20%.

11.2.4.4 'Monitoring'

 → 'Menu / Information → Settings → Metering → Monitor → ...'

11.2.4.4.1 'Air lock'

 → 'Menu / Information → Settings → Metering → Monitor → Air lock → ...'

Should a message and the "Air lock" symbol  appear, this may mean that there is gas in the liquid end (if 'Warning' or 'Error' was set in the 'Air lock' sub-menu).

11.2.4.4.2 'Sensitivity air detect'

 → 'Menu / Information → Settings → Metering → Monitor → Sensitivity air detect → ...'

Using the 'Sensitivity air detect' programmable function, you can adjust the sensitivity of air detection a little to receive as few incorrect alarms as possible.

Tab. 12: There are 3 levels of sensitivity:

normal	maximum sensitivity
medium	average sensitivity
weak	lowest sensitivity. Only use at pressures of < 2 bar.

11.2.4.4.3 Message with overpressure

You can have the pump output a message in the event of overpressure using the programmable 'Message with overpressure' function.

11.2.4.4.4 Message when no pressure

You can have the pump output a message in the event of no pressure using the programmable 'Message when no pressure' function.

11.2.4.4.5 Cavitation

You can have the pump output a message in the event that it identifies cavitation using the programmable 'Cavitation' function.

11.2.4.5 Compensation

Only with 'Automatic' OFF operating mode: Using the 'Compensation' programmable function, you can minimise the influence of back pressure oscillations and thus achieve a high level of dosing precision.



With difficult hydraulic conditions, it may be better to switch off the 'Compensation' function.

11.2.5 Concentration

☰ → 'Menu / Information' → Settings → Concentration → ...'

The desired mass concentration of feed chemical that will subsequently be required in the dissolving medium (e.g. the main flow) can be entered directly in the "Concentration" continuous display.

The principle of entering the concentration:

1. ▶ Select the operating mode.
2. ▶ Set the data for the feed chemical and dissolving medium in the 'Set up'- 'Concentration' menu.
3. ▶ Set the desired concentration in the "Concentration" continuous display.



- The "Concentration" continuous display only appears, if:
 - the pump is calibrated.
 - the 'Concentration' menu was run through in the operating mode used.
 - and 'Concentration control' was switched to 'active' - in the operating mode being used.
- The "Concentration" continuous display switches to the display mode "%" at concentrations above 999.99 ppm.
- When changing between operating modes, the pump saves the settings for each operating mode - providing it is connected to supply voltage.
- If the pump is to display the concentration as a volume concentration, enter "1.00" kg/l for the density of the feed chemical.

11.2.5.1 'Manual' operating mode (settings for the 'Concentration' function)

☰ → 'Menu / Information' → Settings → Concentration
 → Concentration control → Flow of main medium → ...'

The "Concentration input" in 'Manual' operating mode is intended for metering a substance into pipework containing a medium flowing at a constant rate ('main flow') in such a way that it has a specific mass concentration in the flow.



CAUTION!

Danger of too high concentrations

The metering pump can continue to meter if the flow falls or stops entirely.

- Take system-based precautions to prevent the metering pump from continuing to meter in these circumstances.

The prerequisites are that:

- the flowing medium has the same density as water (1 kg/l $\hat{=}$ g/cm³)
- the mass concentration of the feed chemical is known - see the feed chemical safety data sheet (e.g. with 35% sulphuric acid: 35 %)
- the density of the feed chemical is known - see the feed chemical safety data sheet (e.g. with 35% sulphuric acid: 1.26 kg/l $\hat{=}$ g/cm³)
- The measurement unit for the liquid volume is set in the 'System → Volume unit' menu.

Procedure

**CAUTION!**

The precision of the concentration is strongly dependent on:

- the precision of the metering pump calibration.
- the precision of the inputs.

1. ▶ Calibrate the metering pump if it is not yet calibrated - see chapter 'Settings'- 'Calibration' chapter.
2. ▶ Check whether the metering pump is set to 'Automatic' - 'on' metering mode.
3. ▶ Select 'Manual' - 'Operating mode' (possible settings from other operating modes remain saved.).
4. ▶ Select 'Concentration' in the 'Set up' menu.
5. ▶ Set 'active' in the 'Concentration control' menu item and press the [Clickwheel].
6. ▶ Set the 'Main medium flow' (in the pipework) and then press the [Clickwheel].
7. ▶ Set the 'Feed chemical mass concentration' and press the [Clickwheel].
8. ▶ Set the (mass) 'Feed chemical density' and press the [Clickwheel].
 - ⇒ The 'Concentration' menu appears.
9. ▶ Press [Menu] (☰).
 - ⇒ A continuous display appears.
10. ▶ Press the [Clickwheel] to go to the "Concentration" continuous display (ppm or %).
11. ▶ Enter the required mass concentration of the feed chemical in the main flow by pressing and turning the [Clickwheel].

Tab. 13: Possible values of adjustable variables

Adjustable variable	Lower value	Upper value	Increment
Flow in m ³ /h	0000.1	9999.9	0000.1
Mass concentration in %	000.01	100.00	000.01
Mass density in kg/l	0.50	2.00	0.01

11.2.5.2 'Contact' operating mode (settings on the 'Concentration' function)

☰ → 'Menu / Information' → Settings → Concentration
 → Concentration control → Contact gap → ...'

The "Concentration input" in 'CONTACT' operating mode is intended for metering a substance into pipework containing a medium flowing at a variable rate in such a way that it has a specific mass concentration in the flow.

**CAUTION!****Danger of too high concentrations**

The metering pump can continue to meter if the flow falls or stops entirely.

- Take system-based precautions to prevent the metering pump from continuing to meter in these circumstances.

The prerequisites are that:

- the flowing medium has the same density as water ($1 \text{ kg/l} \pm \text{g/cm}^3$)
- the mass concentration of the feed chemical is known - see the feed chemical safety data sheet (e.g. with 35% sulphuric acid: 35 %)
- the density of the feed chemical is known - see the feed chemical safety data sheet (e.g. with 35% sulphuric acid: $1.26 \text{ kg/l} \pm \text{g/cm}^3$)
- a contact water meter is hydraulically installed and connected to the external input of the metering pump.
- The measurement unit for the liquid volume is set in the 'System → Volume unit' menu.

Procedure**CAUTION!**

The precision of the concentration is strongly dependent on:

- the precision of the metering pump calibration.
- the precision of the inputs.

1. ➤ Calibrate the metering pump if it is not yet calibrated - see chapter 'Settings' - 'Calibration' chapter.
2. ➤ Check whether the metering pump is set to 'Automatic' - 'on' metering mode.
3. ➤ Select 'Contact' - 'Operating mode' and simply confirm the associated menu items with the [Clickwheel] (possible settings from other operating modes remain saved.)
4. ➤ Select 'Concentration' in the 'Set up' menu.
5. ➤ Set 'active' in the 'Concentration control' menu item and press the [Clickwheel].
6. ➤ Set the 'Contact gap' and press the [Clickwheel].
7. ➤ Set the (mass) 'Feed chemical concentration' and press the [Clickwheel].
8. ➤ Set the (mass) 'Feed chemical density' and press the [Clickwheel].
 - ⇒ The 'Concentration' menu appears.
9. ➤ Press [Menu] .
 - ⇒ A continuous display appears.
10. ➤ Press the [Clickwheel] to go to the "Concentration" continuous display (ppm or %).
11. ➤ You can enter the desired mass concentration using the [Clickwheel].

Tab. 14: Possible values of adjustable variables

Adjustable variable	Lower value	Upper value	Increment
Contact gap in l/contact	000.10	999.99	000.01
Mass concentration in %	000.01	100.00	000.01
Mass density in kg/l	0.50	2.00	0.01

11.2.5.3 'Batch' operating mode (settings for the 'Concentration' function)

☰ → 'Menu / Information' → Settings → Concentration
 → Concentration control → Volume of main medium → ...'

The "Concentration input" in 'Batch' operating mode, is intended for metering a substance into the medium in a storage tank so that it then has a defined mass concentration in the storage tank (when batching a solution – do not forget to stir!).

The prerequisites are that:

- the medium in the storage tank has the same mass density as water ($1 \text{ kg/l} \triangleq \text{g/cm}^3$)
- the mass concentration of the feed chemical is known - see the feed chemical safety data sheet (e.g. with 35% sulphuric acid: 35 %)
- the density of the feed chemical is known - see the feed chemical safety data sheet (e.g. with 35% sulphuric acid: $1.26 \text{ kg/l} \triangleq \text{g/cm}^3$)
- The measurement unit for the liquid volume is set in the 'System → Volume unit' menu.

Procedure





CAUTION!

The precision of the concentration is strongly dependent on:

- the precision of the metering pump calibration.
- the precision of the inputs.

1. ▶ Calibrate the metering pump if it is not yet calibrated - see 'Set up' - 'Calibration' chapter.
2. ▶ Check whether the metering pump is set to 'Automatic' - 'on' metering mode.
3. ▶ Select 'Batch' - 'Operating mode' and simply confirm the associated menu items with the [Clickwheel] (possible settings from other operating modes remain saved.)
4. ▶ Select 'Concentration' in the 'Set up' menu.
5. ▶ Set 'active' in the 'Concentration control' menu item and press the [Clickwheel].
6. ▶ Set the 'Main medium volume' of the medium in the storage tank and press the [Clickwheel].
7. ▶ Set the (mass) 'Feed chemical concentration' and press the [Clickwheel].
8. ▶ Set the (mass) 'Feed chemical density' and press the [Clickwheel].
 ⇒ The 'Concentration' menu appears.

9.  Press [Menu].
⇒ A continuous display appears.
10.  Press the [Clickwheel] to go to the "Concentration" continuous display (ppm or %).
11.  You can enter the desired mass concentration using the [Clickwheel].

Tab. 15: Possible values of adjustable variables

Adjustable variable	Lower value	Upper value	Increment
Volume in l	0000.1	9999.9	0000.1
Mass concentration in %	000.01	100.00	000.01
Mass density in kg/l	0.50	2.00	0.01

11.2.5.4 'Analogue' operating mode (settings on the 'Concentration' function)

 → 'Menu / Information' → Settings → Concentration
→ Concentration control → Max. flow of main medium → ...'

The "Concentration input" in 'Analogue' operating mode is intended for metering a substance into pipework containing a medium flowing at a variable rate in such a way that it has a specific mass concentration in the flow.



CAUTION!

Risk of incorrect concentrations

- After adjusting, check whether the concentration at various flows corresponds to the required result.

The prerequisites are that:

- the flowing medium has the same density as water (1 kg/l $\hat{=}$ g/cm³)
- the mass concentration of the feed chemical is known - see the feed chemical safety data sheet (e.g. with 35% sulphuric acid: 35 %)
- the density of the feed chemical is known - see the feed chemical safety data sheet (e.g. with 35% sulphuric acid: 1.26 kg/l $\hat{=}$ g/cm³)
- a flow meter with analogue output is hydraulically installed and connected to the external input of the metering pump.
- The measurement unit for the liquid volume is set in the 'System → Volume unit' menu.

Procedure



CAUTION!

The precision of the concentration is strongly dependent on:

- the precision of the metering pump calibration.
- the precision of the inputs.

1. ▶ Calibrate the metering pump if it is not yet calibrated - see chapter 'Settings' - 'Calibration' chapter.
2. ▶ Check whether the metering pump is set to 'Automatic' - 'on' metering mode.
3. ▶ Select 'Analogue' operating mode and confirm with the [Clickwheel].
4. ▶ Set '0...20 mA' or '4..20 mA' in the 'Select analogue' menu item and press the [Clickwheel].
5. ▶ Select 'Concentration' in the 'Set up' menu.
6. ▶ Set 'active' in the 'Concentration control' menu item and press the [Clickwheel].
7. ▶ Set the 'Max. main medium flow' (in the pipework) and press the [Clickwheel]. (It is then assigned to the current value of 20 mA).
8. ▶ Set the (mass) 'Feed chemical concentration' and press the [Clickwheel].
9. ▶ Set the (mass) 'Feed chemical density' and press the [Clickwheel].
 - ⇒ The 'Concentration' menu appears.
10. ▶ Press [Menu] .
 - ⇒ A continuous display appears.
11. ▶ Press the [Clickwheel] to go to the "Concentration" continuous display (ppm or %).
12. ▶ You can enter the desired mass concentration using the [Clickwheel].



CAUTION!

- Note the decimal point.
- The mass concentration is affected by changes in the stroke rate and the stroke length.
- The pump limits the upper value of the mass concentration, because otherwise the incremental jumps when adjusting would be unacceptably large. Adjust the stroke length as necessary - do not set it under 30%.



The least significant figures of the value in the continuous display cannot be changed at will using the [Arrow keys], rather only in incremental jumps resulting from the input data.

As necessary, change the stroke length and adjust the concentration; in doing so the pump compensates via the stroke rate.

Tab. 16: Possible values of adjustable variables

Adjustable variable	Lower value	Upper value	Increment
Max. flow in m ³ /h	0000.1	9999.9	0000.1
Mass concentration in %	000.01	100.00	000.01
Mass density in kg/l	0.50	2.00	0.01

11.2.6 Calibrate

 → 'Menu / Information' → Settings → Calibrate → ...'



Calibration - precision

Normally the pump does not have to be calibrated.

However, the pump should be calibrated for precise metering.

With individual pumps in the product range, the capacity can systematically deviate by -5% to +10% from the specified capacity. A reproducibility of ±2% from the specified capacity remains as a deviation after calibration.



Calibration influences the menu

In 'Auto' - 'off' dosing mode: Some menus only appear if the pump has been calibrated.

Calibrate using Calibr. factor

If you already know what calibration factor is needed for the pump to achieve the desired accuracy, go to 'Calibrate'- 'Calibr. factor' and enter the appropriate calibration factor as a %.

Calibrating using a calibration procedure

If you do not know which calibration factor you need, use this calibration procedure.



WARNING!

If the feed chemical is hazardous, take appropriate safety precautions when performing the following calibration instructions. Observe the material safety data sheet for the feed chemical!



Please only calibrate using the suction hose – as shown here.

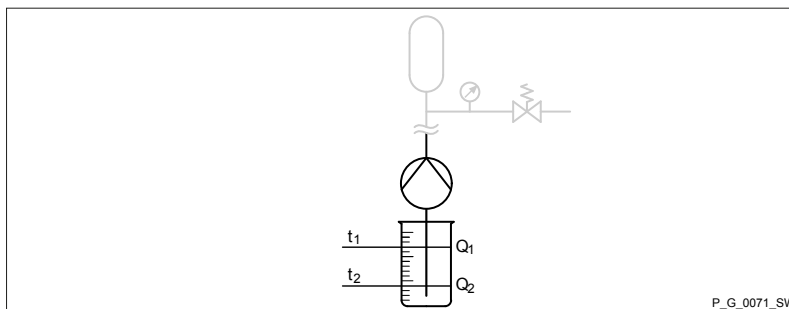

Preparation

1. Use the [Clickwheel] to scroll through the continuous displays to check whether litres or gallons have been selected.
2. If the incorrect volume unit has been selected, correct it in the 'Menu / Information → Settings → System → Volume unit' menu.
3. Check whether the capacity in the continuous display is not too low for calibration.
4. Lead the suction hose into a measuring cylinder containing the feed chemical – make sure that the pressure tube is permanently installed (operating pressure, ...!).
5. Prime the feed chemical (press [Priming]) if the suction hose is empty.

Calibration procedure

1. Record the level in the measuring cylinder.
2. Select the 'Menu / Information → Settings → Calibrate → Calibrate' menu and press the [Clickwheel].
 - ⇒ The 'Start calibration' (PUSH) menu item appears.
3. To start calibration, press the [Clickwheel].
 - ⇒ The 'Calibrate ...' menu item appears, the pump starts to pump and indicates the number of strokes.
4. After a reasonable number of strokes (a minimum of 200), use the [Clickwheel] to stop the pump.
 - ⇒ The 'Calibrate ended' menu item appears. It asks you to enter the calibration volume.
5. Determine the required metering volume (difference between initial volume - remaining volume in the measuring cylinder).
6. Use the [Clickwheel] to enter this volume in the 'Calibrate ended' menu item and close.
 - ⇒ The pump switches to the 'Calibration result' menu item - the pump is calibrated.
7. Press the [Clickwheel].
 - ⇒ The pump returns to the 'Menu / Information → Settings' menu.

11.2.7 System

→ 'Menu / Information → Settings → System → ...'

The 'System' menu splits into the following sub-menus:

- 1 - 'Dosing head'
- 2 - 'Volume unit'
- 3 - 'Pressure unit'
- 4 - 'Pressure adjustment'
- 5 - 'Start behaviour'

11.2.7.1 'Dosing head'

 → 'Menu / Information → Settings → System → Dosing head → ...'



CAUTION!

- Should a different liquid end size be fitted, then the pump must be reprogrammed in the 'Dosing head' sub-menu.
- Reprogram the pump to 'No dosing head' for demonstration purposes or if operating without feed chemical.

11.2.7.2 Volume unit

 → 'Menu / Information → Settings → System → Volume unit → ...'

You can select another unit for the volume in the 'Volume unit' sub-menu.

11.2.7.3 Pressure unit

 → 'Menu / Information → Settings → System → Pressure unit → ...'

In the 'Pressure unit' sub-menu, you can select another unit for the pressure.

11.2.7.4 Pressure adjustment

 → 'Menu / Information → Settings → System → Pressure adjustment → ...'

You can adjust the pressure value, which the pump displays in the 'Pressure adjustment' sub-menu, if it is to differ from the pressure in the discharge line.



There is no 'Pressure adjustment' sub-menu with pumps with SER dosing heads.



Requirements:

- A manometer is installed in the discharge line.
 - Everything is set on the pump.
1. ➤ Shift to the 'Pressure adjustment' sub-menu.
 - ⇒ The 'Start pump' menu item appears.
 2. ➤ Use the [Clickwheel] to confirm 'Yes'.
 - ⇒ The pump starts up.
 - The 'Calibration pressure' menu item appears.
 3. ➤ The 'Calibration pressure' menu item shows at the top the pressure value that the pump is missing. Below that it displays an adjustable pressure value.
 4. ➤ Use the [Clickwheel] to enter the pressure value from the manometer as soon as the pressure value is stable.
 5. ➤ Use the [Clickwheel] to confirm this pressure value.
 - ⇒ The pump stops.
 - 'Pressure adjustment' is now complete.

11.2.7.5 Start behaviour

☰ ➔ 'Menu / Information ➔ Settings ➔ System
➔ Start behaviour ➔ ...'

You can specify the start behaviour of the pump once the supply voltage has been switched on in the 'Start behaviour' sub-menu.

Start behaviour	Description
'always STOP'	The pump always wakes up in "Manual stop via the  [STOP/START] key" mode. It can only be started by pressing  [STOP/START].
'always on'	The pump always starts immediately.
'last status'	The pump always adopts the last status it had before the supply voltage was switched off.

11.2.8 Inputs/outputs

☰ ➔ 'Menu / Information ➔ Settings ➔ Inputs/outputs ➔ ...'

The 'Inputs/outputs' menu is split into the following sub-menus:

- 1 - 'Auxiliary capacity' / 'Auxiliary frequency'
- 2 - 'Relay1' (optional)
- 3 - 'Relay2' (optional)
- 4 - 'Flow monitor' (only if connected)
- 5 - 'Diaphragm rupture' (only if connected)
- 6 - 'Pause input' (optional)
- 7 - 'Niveau monitoring'

11.2.8.1 'Auxiliary capacity' / 'Auxiliary frequency'

 → 'Menu / Information' → Settings → Inputs/Outputs
→ Auxiliary capacity / Auxiliary frequency → ...'

The programmable 'Auxiliary capacity' / 'Auxiliary frequency' function enables switch-over to an additional capacity / stroke rate that can be fixed in the 'Auxiliary capacity' / 'Auxiliary frequency' menu.

It can be activated via the "External control" terminal. If 'Auxiliary capacity' / 'Auxiliary frequency' is being used, then the identifier "AUX" appears on the LCD screen.

Refer to the "Hierarchy of operating modes, functions and fault statuses" for the order of the various operating modes, functions and fault statuses.

11.2.8.2 'Relay1 (optional)'

 → 'Menu / Information' → Settings → Inputs/outputs → Relay1
→ ...'



The setting options for the 'Relay' function are only available if a relay is fitted.

gamma/ XL, GXLa

Tab. 17: Relay, physical and pre-set to ...

Identity code specification	Relay, physical	Pre-set to ...
1	1 x changeover contact 230 V – 8 A	Fault indicating relay, N/C
4	2 x N/O 24 V – 100 mA	Fault indicating relay, N/C, and pacing relay

Relay type

You can reprogram the relays to these types:

Menu setting	Effect
Timer	The relay switches when requested by the timer.
Error	The relay switches in the event of a fault message (red LED*).
Warning	The relay switches in the event of a warning message (yellow LED*).
Warning + error	The relay switches in the event of a warning message (yellow LED*) or a fault message (red LED*).
Warning, error + stop	The relay switches in the event of a warning message (yellow LED*), when stopped by  [Start/Stop] or in the event of a fault message (red LED*).
Pump active	The relay switches as soon as the pump is in standby and not stopped and not in a status like 'Pause' or if an error is pending. In the opposite case, the relay switches back again.
Stroke rate**	The relay switches with every stroke.
Cycle quantity	The relay always switches when the set metering volume is exceeded.
Metering / Batch	The relay changes its status as soon as a batch has been processed.
Bleeding	The relay opens an optionally installed bleed valve as soon as the control activates it.

* see the "Troubleshooting" chapter

** only use 'Relay 2' for this relay type (semiconductor relay).

You can set in the associated menu for certain events whether they are to be signalled as an error or warning (or not) (level, metering stroke, cavitation, ...).

The relays can also switch with programmed errors - refer to the "Troubleshooting" chapter.

Relay polarity

You can set here how a relay is to switch.

Menu setting	Effect
N/C	The relay is closed in normal mode and opens with a triggering event. (N/C)
N/O	The relay is open in normal mode and closes with a triggering event. (N/O)

11.2.8.3 'Relay2 (optional)'

 → 'Menu / Information → Settings → Inputs/outputs → Relay2 → ...'

Relay cycle quantity

You can set the metering volume for which the pacing relay is to switch once here.

For more information on 'Relay2' - see  Chapter 11.2.8 'Inputs/outputs' on page 70.





11.2.8.4 mA output

 → 'Menu / Information → Settings → Inputs/outputs
→ mA-Output → ...'

You can enter here which signal is to be output similar to the pump capacity and as an mA signal and how the pump is to respond. The following can be selected one after the other - Table display:

1. 'mA-Output'	2. 'Select the analogue signal'	3. 'Capacity at 20 mA'	4. 'Behaviour, mA output'	5. 'Behaviour 23 mA'	6. 'Behaviour 3.6 mA'
'0...20 mA' '4...20 mA'	'Strokes / hour'	-	'No change'	-	-
			'Behaviour, mA output'	'Passive' 'Error' 'Warning' 'Warning + error' 'Warning + error + stop' 'Bleeding'	'Passive' 'Error' 'Warning' 'Warning + error' 'Warning + error + stop' 'Bleeding'
	'Litre / hour at 20 mA'	'xx.xx l/h'			

The following can be selected one after the other - Displayed as instructions:

1.  Select the current range in the 'mA-Output' display.
2.  In the 'Select the analogue signal' display, select which of the pump's capacity parameters is to be signalled by the mA output.
3.  Only with 'Litre/Hour at 20mA': Select the capacity (Litre / hour) in the 'Capacity at 20 mA' display, which is to be used for 20 mA (thereby scaling your mA range).
4.  In the 'Behavior mA output' display, select whether the mA output is to signal something or not ('No change').
5.  In the 'Behavior 23 mA' display, select which pump behaviour the mA output is to signal by 23 mA. 'Behavior 3.6 mA' acts in a similar way.



The behaviour selected under 'Behavior 23 mA' has a higher priority when signalling than the one selected under 'Behavior 3.6 mA'.

11.2.8.5 'Flow control'

 → 'Menu / Information → Settings → Inputs/outputs
→ Flow control → ...'



The setting options for the 'Flow control' function are only available if a flow control is electrically installed. The symbol for flow control appears: .

A metering monitor, such as a Flow Control (also DulcoFlow®), can register the individual pressure impacts of the pump and report them back to the pump.

The pump switches to fault mode if this feedback is missing in a sequence, as set under 'Error tolerance'.

It is possible to switch the function on and off under 'Activation'.

Under 'at Auxiliary', it is possible to set whether the function is to be deactivated with auxiliary frequency.

11.2.8.6 'Diaphragm rupture'

 → 'Menu / Information → Settings → Inputs/outputs → Diaphragm rupture → ...'



The setting options for the 'Diaphragm rupture' function are only available if a diaphragm rupture indicator is electrically installed. The symbol for diaphragm appears .

In the 'Diaphragm rupture' sub-menu you can select whether the pump generates a warning message or an error message in the event of a diaphragm rupture.

11.2.8.7 'Pause input'

 → 'Settings → Inputs/outputs → Pause → ...'

In the 'Pause' menu you can select whether the pump switches to 'Pause' with an "Energizing (N/O)" or "Releasing (N/C)" input contact signal.

11.2.8.8 'Niveau monitoring'

 → 'Settings → Inputs/outputs → Niveau monitoring → ...'

Select in the which measuring principle is to be used for level monitoring in the 'Niveau monitoring' menu:

- '2-stage'
- 'continuous'

11.2.8.8.1 2-stage

In the 'Level warning' sub-menu, you can select for a two-stage level switch whether the pump switches to 'Level warning' with a 'Break contact' or 'Make contact' input contact signal.

In the 'Level error' sub-menu, you can select for a two-stage level switch whether the pump switches to 'Error' with a 'Break contact' or 'Make contact' input contact signal.







11.2.8.8.2 Continuous Calibrate

The ProMinent suction lance with continuous level measurement can measure the liquid level in a 30-litre canister with 5 % precision. The relevant secondary display of the gamma/ XL indicates the liquid level, or the liquid level can be reported to the control panel by bus.

You can calibrate continuous level measurement in the 'Calibrate' sub-menu.





Electrodes

You can calibrate the 'electrodes' in this sub-menu – this is a step that is not normally necessary. If the feed chemical has a dielectric constant ϵ_r below 30, you can try to get level measurement running.

1.  Select 'Electrodes' under 'Calibrate'.
⇒ The 'Calibration "Air"' display appears.
2.  Remove the level gauge from the feed chemical.
3.  Press the [dial].
⇒ The 'Calibration "Medium"' display appears.
4.  Immerse the level measurement in the feed chemical up to the holding claws.
5.  Press the [dial].
⇒ The calibration process is completed.
6.  Check whether the level measurement is working as expected.



Perc. liquid level

Use 'Percent level' in this sub-menu to recalibrate the level measurement if you wish to work with another maximum liquid level.

1.  Select 'Percent level' under 'Calibrate'.
⇒ The 'Calib. "Liquid level"' display appears.
2.  Immerse the level measurement in the feed chemical.
3.  Use the [dial] to set the required percentage for this level and press the [dial].
⇒ The application switches back to the Start menu.
4.  Check whether the level measurement is working as expected.

Configuration

You need to enter the warning thresholds for continuous level measurement and the required unit in the 'Configure' sub-menu.

1.  Enter the 'Warning Level Niveau' as a % and press the [dial].
2.  Enter the 'Fault Level Niveau' as a % and press the [dial].

3. → Select the 'Unit Level' for the "continuous level" secondary display: select 'Percent' or 'Liter' and press the [dial].

11.2.9 Config-I/Os

☰ → 'Menu / Information → Settings → Config I/Os → ...'

The 'Config I/Os' menu is used to assign functions to the "Config I/O" (- ☞ 'Control elements, overview' on page 18) socket pins.

Config I/O input

You can configure the pins as an input – for the timer.

Config I/O output

The pins can be configured as outputs (timer, warning, error, auxiliary,...).

It is also possible to use 'Selective errors' or 'Selective warning' to issue very specific errors or warnings (Diaphragm rupture, Defective stroke met., Air in dosing head, ...).

11.2.10 Bleeding

☰ → 'Menu / Information → Settings → Bleeding → ...'

The 'Bleeding' function is used for controlled bleeding of the liquid end.

The software solution is always in the pump control. The pump calls up the 'Priming' function for bleeding. The pump can therefore pump the gas bubbles out of the liquid end even without a bleed valve (solenoid valve) – depending on the back pressure.

If the pump has "Automatic bleed" via the "relay identity code" option (retrofitable), the pump can be bled via a bleed relay.

There are 2 hardware options for automatically bleeding the discharge side:

- via ProMinent's bleed module in the liquid end.
- via a customer implemented bleed facility in the discharge line.



The relay - "Relay" – "with automatic bleed" - changes its switching status for the period during which the pump is priming.

The 'Bleed' function can be triggered in 4 ways:

- 1 - Not ('Off').
- 2 - 'Periodically' by an internal signal - defined by 'Cycle' and 'Duration'.
- 3 - By the 'Air lock' internal signal
- 4 - If one of the two signals occurs ('Both').

Detailed explanation:

- 1 - If 'Off' has been selected in the menu, this function is deactivated.
- 2 - If 'Periodic' was selected in the menu, then the control unit periodically triggers the bleed procedure with an adjustable 'cycle' (10 ... 1440 min = 24 h) and an adjustable 'duration' (5 ... 300 s = 5 min).

Bleeding is always triggered at the start of a period. A bleed process is also started by  [STOP/START] or by connecting the pump to mains voltage.











- 3 - If 'Air lock' has been selected in the menu, the 'Air lock' internal signal triggers the bleed procedure.

If the signal appears again within 8 minutes of the bleed procedure being carried out, the control unit repeats the bleed procedure up to a maximum of 3 times. However if the signal still appears, then an error message is generated, which has to be acknowledged via the [dial].

In the event of an 'Air lock' the option of a direct error or warning message disappears for the 'Air lock' signal. The corresponding menu branch in the 'Settings' menu is also hidden. The signal is only available for the 'Bleed' function.

- 4 - If 'Both' has been selected in the menu, then each trigger can trigger a bleed process.

Sequence of the bleed procedure (automatic):

1.  The pump control stops the normal metering operation - the  "Stop Pause" symbol appears on the LCD screen.
2.  Only with bleed relay: After 1 s, the pump control opens the bleed valve on the liquid end (via the bleed relay and the solenoid valve).
3.  1 s later, the pump starts to run at a high stroke rate (like during priming) - the "Air lock" symbol  appears on the LCD screen instead of the "Stop Pause" symbol.
4.  The pump operates in this way for the total set time.
5.  Once the set time has elapsed, the pump stops – the "Stop Pause" symbol  appears on the LCD screen again.
6.  Only with bleed relay: After 1 s the pump control closes the liquid end bleed valve.
7.  After 1 s the "Stop Pause" symbol  disappears and the pump recommences normal operation.

If the pump was in the "Stop" state at the time of triggering ( [STOP/START], Pause, Error), the start of the bleed procedure is delayed - until this state has been cleared.

If the pump switched to "Stop" state during the bleed procedure, the pump control jumps immediately to phases 5 and 6. - see above. This definitely cancels the bleed procedure. As soon as the "Stop" state is cleared, the bleed procedure starts from the beginning.

11.2.11 'Priming time'

 → 'Menu / Information' → Settings → Priming time → ...'

In the 'Priming time' menu, you can select how long the metering pump is to prime once  [Priming] has been pressed.





In operation, the stroke length can be changed more easily using the "Priming time" display:

- Press  [Priming] - the pump starts to prime.
- Turn the [Clickwheel] to set the priming time.
- Press the [Clickwheel] to save the priming time.

11.2.12 'Set time'

 → 'Menu / Information → Settings → Set time → ...'

You can set the time in the 'Set time' menu.

1.  Use the dial to adjust a figure.
2.  Use  [Priming] to move to the next figure.

Under 'Auto. Summertime' you can select whether you wish to change over to 'Summertime'.

You can also state when the pump is to change to and from 'Summertime'.

Check under 'Location' whether the pump is also set to your 'hemisphere' of the world.

11.2.13 'Date'

 → 'Menu / Information → Settings → Date → ...'

You can set the date in the 'Date' menu.

11.3 Timer

 → 'Menu / Information → Timer → ...'



- *Please first read this chapter completely to gain an overview. You will then understand the timer better when working through the chapter.*

The timer gamma/ XL can do the following at predefined times and intervals or event-dependent:

- open / close the relays
- switch the level of a Config I/O output
- be triggered by the level at a Config I/O input
- start a delayer
- switch operating mode
- operate the pump work at a defined capacity or stroke rate / stroke length

- stop / start the pump
- trigger a batch ('Batch (time)')

11.3.1 Activation / deactivation

☰ → 'Menu / Information → Timer → Activation → ...'



You can only program the timer when 'Activation' is set to 'inactive'.

- ➔ To program the timer, set 'Activation' to 'inactive'.
 - ⇒ The first line of the timer menu 'Timer state' then shows 'inactive'.

- ➔ To activate the timer, set 'Activation' to 'active'.
 - ⇒ The first line of the timer menu 'Timer state' then displays 'active'.

The timer starts working - the timer identifier ⌚ is visible in the continuous display.



When 'Activation' is set to 'active', the timer software generates the status of the pump which the pump would have precisely had at this time if it had been set to 'active' without any interruption.

Delayed, linked actions are unaffected by this.

11.3.2 Setting the timer

☰ → 'Menu / Information → Timer → Set Timer → ...'

You can create commands (also known as "program lines") for a timer program in the 'Set Timer' menu.

You can create up to 99 commands (program lines).

Create the command as follows:

- 1 - Create a 'new' command (program line)
- 2 - Select the 'Triggering event' (trigger) and the time and/or interval if necessary
- 3 - Select 'Action' and a value, if necessary
- 4 - Check the command
- 5 - Create the next command – if necessary

The following administration functions are available to manage the commands (program lines):

- 1 - Reprogram program line ('New')
- 2 - Check program line ('Show')
- 3 - Change program line ('Change')
- 4 - Clear individual program line ('Clear')
- (5 - Clear the entire program ('Clear all' one level higher))



CAUTION!

The pump does not perform any plausibility check. Please ensure before using that the timer actually does what you expect of it. Please consider the consequences for your system.



CAUTION!

A program set up in 'Automatic' - 'on' metering mode will not function in 'Automatic' - 'off' metering mode and vice versa.



CAUTION!

If you wish to use automatic summer time adjustment ('Settings' - 'Time') avoid any triggering events between 02:00 a.m. and 03:00 a.m.



Restriction with day numbers

If you wish to start an action on a certain day of each month, note that the timer only permits days 01 - 28.



Using Config I/Os

If you wish to use Config I/Os as inputs or outputs, you first need to configure them as a 'Timer input' or 'Timer output' under 'Menu / Information → Settings → Config I/Os → ...'.

11.3.2.1 Reprogramming program line ('new')



CAUTION!

If the 'Timer state' is set to 'active', the pump can neither be set nor programmed!

To do so, set the 'Timer state' under 'Activation' to 'inactive'.

11.3.2.1.1 Principle construction of a program line

In principle, an (imaginary) program line / instruction is set up as follows:

Time event (trigger)		Action	
Workdays 1 (Mo-Fr)	Time of day 12:00	Manual	20.00 l/h

This corresponds to the following instruction:

WHEN triggering event, THEN action

The **time event (trigger)** defines what action or at what time an action is to take place.

The **action** defines which type of action is to take place.

The finished program line/ instruction looks like this:

Instruction 03/05
workdays 1 (Mo-Fr) 12:00
Manual 20.00 l/h

B1106

Example

Time event (trigger)		Action	
Workdays 1 (Mo-Fr)	Time of day 12:00	Manual	20.00 l/h

The example means:

When it is 12:00 on a workday, then the pump is to work in 'Manual' operating mode at 20.00 l/h.

Tab. 18: Time events (triggers)

Time events (triggers)	Description	Remark
Time	Switching time reached	For more information - see ↗ Chapter 11.3.2.1.3 'Selecting cyclic time events and switching point' on page 83
'Init'	Thus declared is started at the beginning of the program process	Defines starting conditions - see ↗ Chapter 11.3.2.1.2 'Init' Initial conditions' on page 83
'Delayer'	Delay time of delayer D: xx expired	-
'Config I/O' input	0/1 contact at input I: x	Socket pins on the very left of the pump *

*refer to "Overview of equipment" chapter

The 'Config I/O' inputs first need to be assigned to the timer under 'Menu / Information → Settings → Config I/Os → ...'.

You can select an action and also a value:

Tab. 19: Action

Action	Description	Value
'Manual'	Switch over in this operating mode	Litre/h ('Dos. capacity')
'Manual'	Switch over in this operating mode	Litre/h *1 ('Dos. capacity')
		Strokes/h *2 ('Metering rate') + 'Stroke length'
'Halt'	Stop pump	--
'Relay1 **'	Have the relay switch to status ...	open closed
'Relay2 **'	Have the relay switch to status ...	open closed
'Contact'	Switch over in this operating mode	--
'Batch (input)'	Switch over in this operating mode	--
'Analogue'	Switch over in this operating mode	--
' Start delayer'	Activate a delayer	
'Frequency *2'	The pump runs at this stroke rate	Strokes/h ('Metering rate')
'Config I/O 1'	Switch the level of the Config I/O 1 output to ...	open closed
'Config I/O 2'	Switch the level of the Config I/O 2 output to ...	open closed
'Config I/O 3'	Switch the level of the Config I/O 3 output to ...	open closed

*1: only available in 'Automatic' operating mode - see chapter 'Settings' - 'Automatic'

*2: only available, if metering is done traditionally/conventionally - see chapter 'Settings' - 'Automatic'

* refer to the "Overview of equipment" chapter and 'Menu / Information → Settings → Config I/Os → ...'

** Option; needs to be assigned to the 'Timer' (under 'Settings → Inputs/Outputs → Relay → Relay type' - refer to this chapter of the operating instructions under 'Settings')

Tab. 20: Selected value ranges

Designation	Value range
Line numbers	01 ... 99
Day (date)	01 ... 28
Time of day (hours)	00 ... 23
Seconds	0001 ... 9999
No. of delayer D:	01 ... 15

11.3.2.1.2 'Init' Initial conditions

The triggering event 'Init' can be used to set initial conditions at the beginning of a program sequence.

Example

triggering event (trigger)		Action	
Init	-	Relay 2	closed
Init	-	Contact	-

The example means:

As soon as the programme is started (via 'Timer → Activation → active' or power supply on), 'Init' sets 'Relay 2' to 'closed' and the 'Operating mode' to 'Contact'.

11.3.2.1.3 Selecting cyclic time events and switching point

The cyclic time events periodically trigger actions. That is why a program line consists of a cycle and a switching point:

The **cycle** specifies after which time the action is to be repeated.

The **switching time** specifies when the action is to take place.

Example

Time events (triggers)		Action
Cycle	Switching time	
Workdays 1 (Mo-Fr)	Time of day 12:00	Manual

Tab. 21: Cyclic time events

Cycle	Time
'hourly'	hourly at mm. Minute
'daily'	daily at the time mm.ss, Monday to Sunday
'Workdays 1 (Mo-Fr)'	daily at the time mm.ss, Monday to Friday
'workdays 2 (Mo-Sa)'	daily at the time mm.ss, Monday to Saturday
'Weekend (Sa+Su)'	daily at the time mm.ss, Saturday and Sunday
'weekly'	weekly at the time mm.ss on day xxxxxx.
'monthly'	monthly at the time mm.ss on the day dd. Day* of the month

* Value range is restricted to day 01 – 28

**CAUTION!**

If you wish to use automatic summer time adjustment ('Settings' - 'Time') avoid in principle any time events between 02:00 and 03:00.



A time event lets you trigger an action precisely to the minute.

If the action is to be triggered precisely to the second, then you need to set up your programming on a delayer.

11.3.2.1.4 Delayer

A delayer lets you delay an action with regard to a time event (trigger).

Delayers can be both time events and also actions.

Example of a program

No.	Time event (trigger)		Action	
01	Config I/O 1	close	Start Delayer 1	-
02	Config I/O 1	close	Start Delayer 2	-
03	Config I/O 1	close	Start Delayer 3	-
04	Init	-	Halt	-
05	Delayer 1	after 60 sec	Config I/O 2	close
06	Delayer 2	after 120 sec	Manual	100 strokes / min, 60 % stroke length
07	Delayer 3	after 180 sec	Halt	-
08	Delayer 3	after 180 sec	Config I/O 2	open

The example means:

A flank at 'Config I/O 1' means that ...:

- after 60 s output 'Config I/O 2' is closed,
- after a further 60 s, the pump pumps in 'Manual' operating mode at 100 strokes / min and 60% stroke length,
- stops after a further 60 s and output 'Config I/O 2' opens again.

A program line with a time event 'Delayer' X thus also includes the element 'Delay time'.

The 'Delay time' specifies by which time the start of the selected action is to be delayed (1 s ... 9,999 s = approx. 2 h 45 min).

The delayer itself must first have been called up by a time event as an action. You can use 15 different delayers.



- With the time event 'Delayer' X, you can trigger an action precisely to the second.
- The clock of the gamma/ XL has an accuracy of $\pm 1 \text{ s}/24 \text{ h}$.

11.3.2.1.5 Inputs

A 0/1 contact signal, for example at pin 1 of the 'Config I/O' socket can be a triggering event.

Example

Time events (triggers)	Action	
Config I/O 1	Relay 2	open

The example means:

If a 0/1 contact signal is closed between pin 1 of the 'Config I/O' socket and pin 4, then the 'Relay 2' should switch to 'open' status.

11.3.2.1.6 Outputs

The timer can output a 1/0 contact signal e.g. between pin 3 of the 'Config I/O' socket and pin 4.

Example

Time events (triggers)		Action
Cycle	Switching time	
Workdays 1 (Mo-Fr)	Time of day 12:00	Config I/O 3

The example means:

At 12:00 on workdays, the timer outputs a 1/0 contact signal between pin 3 of the 'Config I/O' socket and pin 4

11.3.2.2 1 time event - several actions

You can assign 1 time event to several actions. To do so, always use the same cycle and the same switching time! :

Example

No.	Time event (trigger)		Action	
01	Workdays 1 (Mo-Fr)	Time of day 12:00	Halt	-
02	Workdays 1 (Mo-Fr)	Time of day 12:00	Batch (input)	50 strokes
03	Workdays 1 (Mo-Fr)	Time of day 12:00	Relay 1	-closed
04	-	-



- For details on the sorting sequence of the program lines see ↗ 'Sorting sequence' on page 86.
- The timer program can have a maximum of 99 program lines.

11.3.2.3 Check program lines ('Show')

☰ → 'Menu / Information → Timer → Set timer → Show'

'Show' lets you check individual program lines / instructions.

1. ▶ Press the [Clickwheel] on a program line / instruction.

⇒ This display appears:

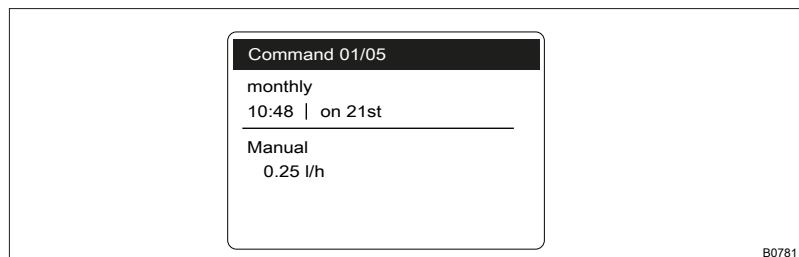

Above the line Time event (trigger) and possible value
Below the line Action and value, if required

2. ▶ Turn the [Clickwheel].

⇒ Scroll from instruction to instruction.

The number of the program line or instruction (and the number of the last program line or instruction) appears at the top in the dark bar.

3. ▶ Pressing the [Clickwheel] returns you to 'Set timer'.



As the timer software automatically sorts the program lines, the numbers of the program lines can change if you change something.

Sorting sequence

The timer software automatically sorts every newly programmed program line / instruction after completing it (press the [Clickwheel]) below the other program lines.

The 1st sorting criterion is the type of **time event (trigger)** (for the sequence refer to ↗ *Further information on page 81* and ↗ *Further information on page 83*).

Time-dependent program lines are ordered below each other initially after the **Switching point** (2nd sorting criterion)



then after the length of the **Cycle** (3rd sorting criterion).

The 4th sorting criterion is the type of **action** (see also the programming examples at the end of these instructions).

A purely time-controlled timer program will also run in this sequence.



11.3.2.4 Change program lines ('Change')

 → 'Menu / Information → Timer → Set timer → Change'

1.  Use the [Clickwheel] to select the required program line / instruction according to its number and press the [Clickwheel].
2.  Click through the instruction and change it.
 - ⇒ The timer software sorts a changed program line / instruction after completion with the [Clickwheel] possibly differently in between the other program lines (Rules - see  'Sorting sequence' on page 86).

11.3.2.5 Clear individual program lines ('Clear')

 → 'Menu / Information → Timer → Set timer → Clear'

1.  Use the [Clickwheel] to select the required program line / instruction according to its number.
2.  The program line will be cleared as soon as you press the [Clickwheel].
 - ⇒ The timer software re-sorts the remaining programme lines (Rules - see  'Sorting sequence' on page 86).



Clear all program lines

The option to clear all program lines is to be found one level higher in the menu:

 → 'Menu / Information → Timer → Clear all'

11.3.3 Clear all

 → 'Menu / Information → Timer → Clear all → ...'

Use the 'Clear all' menu to clear all instructions (the entire program).

11.3.4 Examples

Requirements:

- You have already worked with the pump type
- The time has been set (possibly set under 'Settings → Set time → Time'. Only possible with 'Timer state'- 'Inactive').

Example of "Weekday metering"

Task:

The pump is to meter 2 litres every half hour every weekday (Mon-Fri) between 8:00 and 11:00.

Solution:

As you define switching times with the timer, you need to first define the switching points at 08:30, 09:30 and 10:30.



To meter 2 litres, the pump needs to work in 'Manual' 'Mode' for 10 min at a 'Dos. capacity' of 12,000 l/h. A 'Dos. capacity' of 12,000 l/h is thereby added to the switching points.

You also need to define the switching times to stop the pump at 08:40, 09:40 and 10:40 - paired with the 'Halt' action.

Tab. 22: Program as program lines / instructions

No.	Time event	Action		Comment	
		Switching time	Capacity		
01	Workdays 1 (Mo-Fr)	08:30	Manual	12,000 l/h	Meter at 12,000 l/h
02	Workdays 1 (Mo-Fr)	08:40	Halt	-	Halt
03	Workdays 1 (Mo-Fr)	09:30	Manual	12,000 l/h	Meter at 12,000 l/h
04	Workdays 1 (Mo-Fr)	09:40	Halt	-	Halt
05	Workdays 1 (Mo-Fr)	10:30	Manual	12,000 l/h	Meter at 12,000 l/h
06	Workdays 1 (Mo-Fr)	10:40	Halt	-	Halt

How to enter the program lines / instructions:

1. ▶ To program the timer, set  → 'Menu / Information' → 'Timer' → 'Activation' to 'inactive'.
 - ⇒ The first line of the timer menu 'Timer state' then shows 'Inactive'.
2. ▶ Always enter the program / instructions from the table, above, into the newly created instruction under 'Timer' → 'Set timer' → 'new' → ... (Do not get irritated: the timer program automatically sorts the instructions).
3. ▶ To activate the timer, set 'Activation' to 'active'.
 - ⇒ The first line of the timer menu 'Timer state' then displays 'active'.
 - The timer starts working - the timer identifier  is visible in the continuous display.

4.  Test your programming!

The secondary display "Timer" can help with this as it shows the next instruction and the remaining time. (To access this secondary display, press the [Clickwheel] in a continuous display until a long series of small circles appears below - immediately turn the [Clickwheel] to navigate to the last circle and press the [Clickwheel].)

The continuous display itself shows information on the current status of the pump in the dark bar.

***If something has been entered incorrectly:***

- Either press  in the current program line and enter the correct values
- or search for the program line in 'CHANGE' (automatic sorting!). Now press the [Clickwheel], allow the program to run through the program lines again and enter the values correctly
- or use 'Clear' to select the program line and clear
- or clear everything using 'Clear all' (one level higher).

Example - to avoid errors

The example is intended to provide the programmer with a couple of "programming obstacles" that he might not immediately see:

Com-mand	Time event	Additional parameter	Action	Additional parameter	Comment
01	Config I/O 1	Input, reacts when closing	Start Delayer 1		When a contact closes between pins 1 and 4 at "Config I/O" socket, this starts delayer 1
02	Config I/O 1	Input, reacts when closing	Start Delayer 2		When a contact closes between pins 1 and 4 at "Config I/O" socket, this starts delayer 2
03	Config I/O 1	Input, reacts when closing	Start Delayer 3		When a contact closes between pins 1 and 4 at "Config I/O" socket, this starts delayer 3
04	Init		Halt		Pump stops as soon as the timer is activated
05	Delayer 1	after 60 sec	Close Config I/O 2		Pins 2 and 4 of the "Config I/O" socket act like a normally closed contact – enabling you to control a device
06	Delayer 2	after 120 sec	Manual	12,000 l/h and 80 % stroke length	Pump runs after 120 s at 12,000 strokes/h and 80 % stroke length
07	Delayer 3	after 180 sec	Halt		Pump stops after 180 s
08	Delayer 3	after 180 sec	Open Config I/O 2		Pins 2 and 4 of the "Config I/O" socket act like a normally open contact – enabling you to control a device

Explanations:

- If 1 time event (trigger) is to trigger 3 actions that are to have delays of different lengths, then you need to start 3 delayers and not just 1 - see instructions 01 to 03.
- If several actions are to be performed after the same delay time, then you need to write exactly as many instructions – with the same time event (instructions 07 and 08).

- If, for example, you are using '*Delayer 1*' - '*60 s*' and '*Delayer 1*' - '*120 s*', then the action is never performed after the second (longer) delay time because the delayer has been activated after the shorter delay time and becomes inactive.
- Without '*Init*' - '*Halt*' (instruction 04) it would remain unclear whether the pump alone runs by '*Activation*' of the timer. Activating the timer namely clears all causes for stop: If the pump has previously been manually stopped, for example in '*Manual*' operating mode at 12 l/h, then it suddenly pumps at 12 l/h when the timer is activated, which cannot be seen from the timer program.
- If a contact at '*Config I/O 1*' cannot start the program, then it may be due to the fact that the contact is not defined as a "Timer input" (in the '*Menu / Information*' → '*Settings*' → '*Inputs/Outputs*' → '...' menu).
In the same way, '*Config I/O 2*' (instruction 08) would have to be defined here as a "Timer output".

11.3.5 Timer information

"Config I/O" socket

There is an option to feed the signals of up to 3 external potential-free contacts as inputs to the pump via the "Config I/O" socket or issue up to 3 contact signals as outputs (total of inputs + outputs = 3).

Pin assignment - see chapter entitled "Installation, electrical" - "Description of the sockets".

The function of the pins must be assigned under '*Settings*' → '*Config I/Os*'.

Status as soon as the programmed pump is connected to the power supply:

The timer software now generates the status of the pump which the pump would have precisely had at this time if it had not been disconnected from the power supply.

This relates to linked or non-delayed actions.

Effective settings after switching between Timer '*active*' and '*inactive*':

The timer settings are saved and become effective again when '*inactive*' switches to '*active*'.

The operating mode settings are saved and become effective again when '*active*' is switched to '*inactive*'.

Storage period of your programming:

The pump stores your programming for up to 20 years.

(The calibration and timer data is maintained for up to 100 years).

The time is retained without power supply for approx. 2 years.

11.3.6 Typical pitfalls Timer functional faults

Problem	Possible cause of fault	Remedy
The pump starts pumping unexpectedly.	The timer clears every "Manual" stop when activated - see "Timer behaviour on start"	Enter an 'Init' instruction with 'Halt' action.
The timer does not react to a contact signal at the corresponding pin of the "Config I/O" socket.	Config I/O was not configured as "Config I/O" - "Input" in the 'Menu / Information → Settings → Inputs/Outputs → ...' menu.	Configure Config I/O as "Config I/O" - "Input" in the 'Menu / Information → Settings → Inputs/Outputs → ...' menu.
The timer does not set a Config I/O output.	Config I/O was not configured as "Timer" - "Input" in the 'Menu / Information → Settings → Inputs/Outputs → ...' menu.	Configure Config I/O as a "Timer" - "Input" in the 'Menu / Information → Settings → Inputs/Outputs → ...' menu.
A 'Delayer' does not trigger an 'Action'.	Different delay times have been defined for the same 'Delayer' but this delayer is stopped and becomes inactive after the shortest delay time.	Create a further 'Delayer' for the longer delay time.

11.3.7 Brief explanation of selected functions

Time event (trigger)

An event can be triggered either time-dependent or event-controlled.

- 1 - Time events (really time-dependent) are processed precisely to the minute.
- 2 - Initialisation ('Init') is executed at the start of the program ('Timer → Activation → active' or when the power supply is connected) to obtain a defined status of the system.
- 3 - "Config I/O" inputs can trigger something if the input potential changes from 1 to 0 or with a falling edge or if the potential-free contact is closed.
- 4 - Delayers can trigger an action as soon as their time has expired - precisely to the second.

Actions

These are the 'Actions' which the timer executes as soon as a 'time event' has occurred.

Initialisation

When 'Activation' is set to 'active', the timer software generates the status of the pump which the pump would have precisely had at this time if it had been set to 'active' without any interruption.

This does not relate to delayed, linked actions.

The initial commands ('Init') can be used to program a defined switch-on status. Initial commands have priority over time commands.

Outputs

Those relays which were connected with the relay option are designated as outputs. There can be up to 2 relays.

Pins 1 - 3 of the "Config I/O" socket can be inputs and outputs. That can be programmed.

Inputs

Pins 1 - 3 of the "Config I/O" socket can be inputs and outputs. That can be programmed.

Delayer

Delayers are started event- or time-controlled. On expiry of the delay time, the delayer itself can trigger any actions.

11.4 'Service'

 → 'Menu / Information → Service → ...'

11.4.1 'Access protection'

 → 'Menu / Information → Service → Access protection → ...'

You can lock parts of the setting options here.

The following locking options are available:

Selection	Point ①	Point ②
'None'	-	-
'Lock menu'	X	-
'Lock all'	X	X

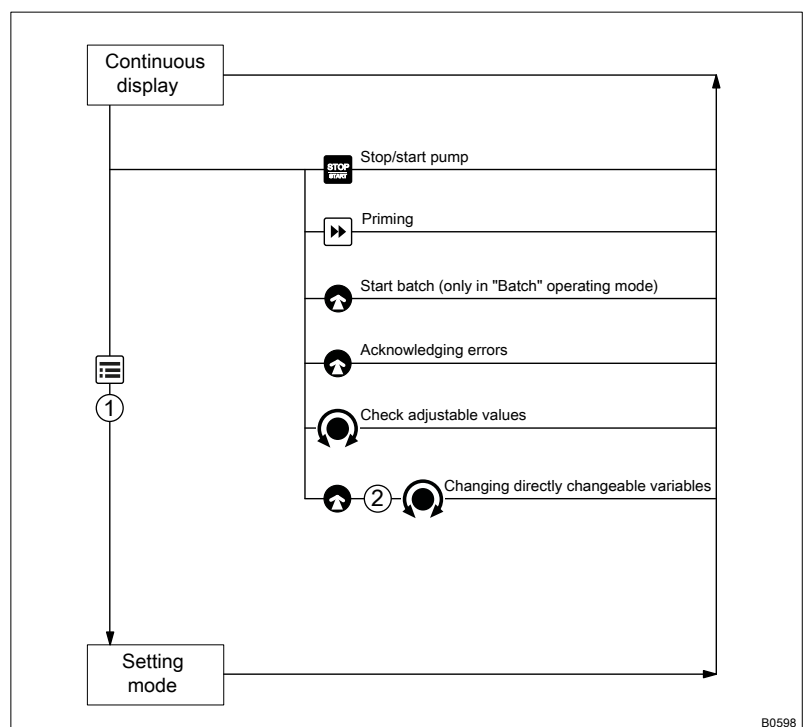



Fig. 37

If you have set a 'Password' - see below, then the identifier  will appear after 1 minute in the top left and the specified areas will be locked, if no key has been pressed in the meantime.

Both locks use the same 'Password'.

11.4.2 'Password'

 → 'Menu / Information → Service → Password → ...'

You can enter a password of your choice in the 'Change password' menu.

11.4.3 'Clear counters'

 → 'Menu / Information → Service → Clear counters → ...'

You can reset the counters to "0" in the 'Clear counters' menu:

- 'Stroke counter' (total number of strokes)
- 'Volume counter' (total litres)
- 'Contact memory'
- 'All'

➔ To clear: exit the menu by briefly pressing the [Clickwheel].

The values have increased since commissioning the pump, the last calibration or the last deletion.

11.4.4 'Error log book'

 → 'Menu / Information → Service → Error log book → ...'

You can view the list of 'Log book entries' here.

A 'filter' helps with the overview.



If you need more detailed log book entries:

The metering pump gamma/ XL with Bluetooth functionality can display a more extensive log file with pump-related events and e-mail it using a Bluetooth-compatible Android smart device and the "gamma/ XL" app.

11.4.4.1 Log book entry - Detailed view

Press the [Clickwheel] to obtain more information about a log book entry.

Tab. 23: Information on the detailed view

Line	Information
1	Date/time
2	Type of entry (fault, warning ...)
3	Total operating time, total number of strokes

Line	Information
4	Switching-on duration, stroke rate since switching on
5	Room temperature, status information on the error (for developers)

11.4.5 'Diaphragm replacement'

 → 'Menu / Information → Service → Diaphragm replacement → ...'

You can move the slide rod into the "replacement position" here with 'To change position' to enable the diaphragm to be replaced more easily.

11.4.6 'Display'

 → 'Menu / Information → Service → Display → ...'

You can set the 'Contrast' and the 'Brightness' of the LCD screen here.

11.4.7 'Factory settings'

 → 'Menu / Information → Service → Factory setting → ...'

You can reset the pump to its factory settings here by selecting 'Yes'.

The password is the last 4 digits of the serial number.

11.4.8 Diaphragm part number: XXXXXXXX

 → 'Menu / Information → Service → Diaphragm part number: XXXXXXXX → ...'

You can read off the part number (order number) of the correct diaphragm here.

11.4.9 Spare parts kit part number: XXXXXXXX

 → 'Menu / Information → Service → Spare parts kit part number: XXXXXXXX → ...'

You can read off the part number (order number) of the correct spare parts kit here.

11.5 *'Language'*

 → *'Menu / Information → Language → ...'*

You can select the desired operating language in the *'Language'* menu.

12 Operation

This chapter describes all the operating options in a continuous display (several symbols and the pressure display appear at the top in the black bar) for the person trained on the pump.



– Please also refer to the "Operating/Setting overview" and "Continuous displays and secondary displays" overviews at the end of the operating instructions and also the "Overview of equipment and control elements" chapter.

12.1 Manual operation

Stop/start pump

Stop the pump: Press  [STOP/START].

Start the pump: Press  [STOP/START] again.

Priming

Press  [Priming].

Turn the [Clickwheel] to lengthen or shorten the priming time during priming.

Start a batch

In 'Batch' operating mode: Press the [Clickwheel] in the 'Push' continuous display.

Acknowledging errors



Press the [Clickwheel] to acknowledge error messages that require acknowledgement.

Check adjustable variables

In a continuous display: Another continuous display appears each time the [Clickwheel] engages when turned. (The number depends on the configuration.)

Changing directly adjustable variables

Changing a variable in the relevant continuous display:

1.  Press the [Clickwheel].
⇒ The variable can be changed (highlighted).
2.  Turn the [Clickwheel].
⇒ The variable is changed.
3.  Press the [Clickwheel].
⇒ The variable is saved (the highlighting disappears).

If the "lock" - "lock all" has been set - see  'Set-up overview gamma/XL' on page 98, first enter the 'Password' after pressing the [Clickwheel].

List of directly changeable variables:

- Capacity
- Stroke rate
- Stroke length
- Factor

- Contact volume
- Batch dosing time
- Concentration

Set-up overview gamma/ XL

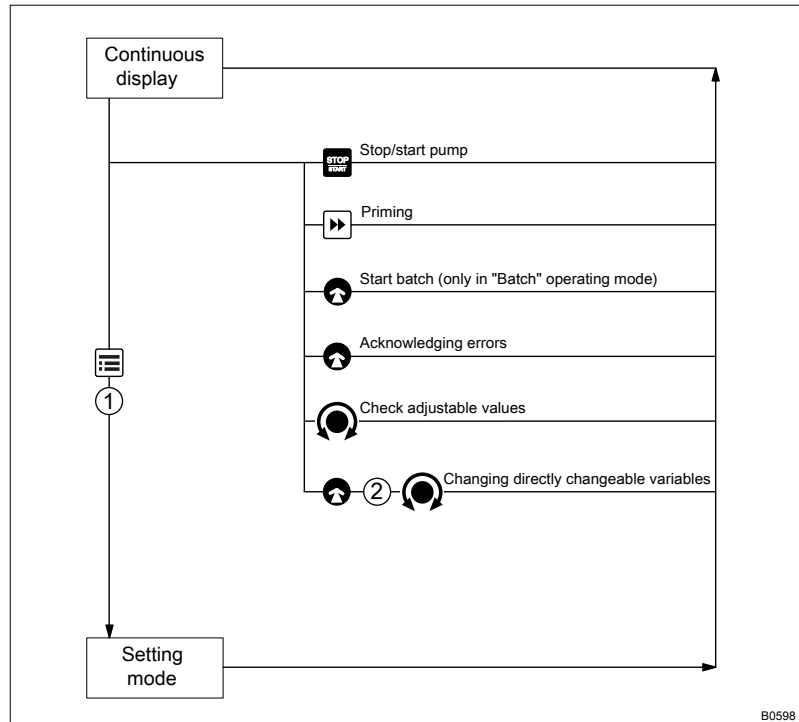

Fig. 38: Control options using keys and locking options

- ⏏ Press [Clickwheel]
- 🔄 Turn [Clickwheel]
- ① "Lock menu"
- ② "Lock all"

13 Maintenance



WARNING!

It is mandatory that you read the safety information and specifications in the "Storage, Transport and Unpacking" chapter prior to shipping the pump.



CAUTION!

Warning of feed chemical spraying around

Feed chemical may spray out of the hydraulic components if they are tampered with or opened due to pressure in the liquid end and adjacent parts of the system.

- Disconnect the pump from the mains power supply and ensure that it cannot be switched on again by unauthorised persons.
- Ensure that the system is at atmospheric pressure before commencing any work on hydraulic parts of the system.



Third-party spare parts for the pumps may result in problems when pumping.

- Only use original spare parts.
- Use the correct spare parts kits. In the event of doubt, refer to the exploded views and ordering information in the appendix.

Standard liquid ends:

Interval	Maintenance work	Personnel
Quarterly*	<ul style="list-style-type: none"> ■ Check that the hydraulic lines are fixed firmly to the liquid end. ■ Check that the discharge valve and suction valve are fitted tightly. ■ Check that the entire liquid end is leak-tight - particularly around the leakage hole - refer to Fig. 39. ■ Check that the flow is correct: Press  [Priming] to allow the pump to prime briefly. ■ Check that the electrical connectors are intact. ■ Check the integrity of the housing. ■ Check that the dosing head screws are tight. 	Technical personnel

* Under normal loading (approx. 30% of continuous operation).
Under heavy-duty loading (e.g. continuous operation): Shorter intervals.

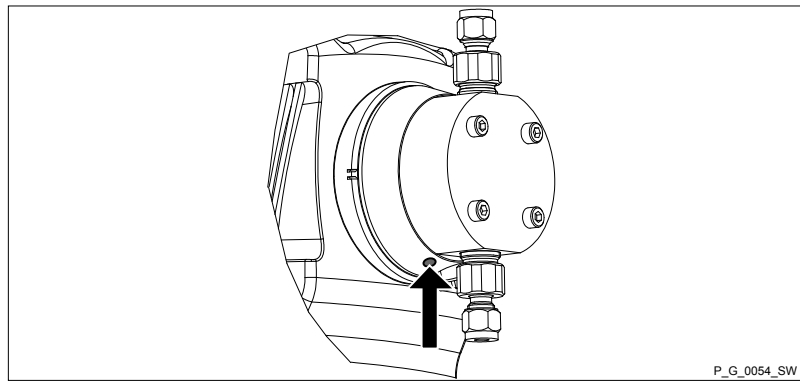

Fig. 39: The leakage hole

Interval	Maintenance work	Personnel
Annually*	<ul style="list-style-type: none"> ■ Check the diaphragm for damage - refer to "Repair" 	Technical personnel

* Under normal loading (approx. 30% of continuous operation).

Under heavy-duty loading (e.g. continuous operation): Shorter intervals.

Check the metering diaphragm more frequently or use a diaphragm rupture indicator with feed chemicals that put particular pressure on the diaphragm, e.g. those containing abrasive additives.

Liquid ends with bleed valve - additionally:

Interval	Maintenance work
Quarterly*	<ul style="list-style-type: none"> ■ Check that the bypass line is fixed firmly to the liquid end. ■ Check that the bleed valve is tight. ■ Check the discharge and bypass line for kinks. ■ Check that the bleed valve is operating correctly.

* Under normal loading (approx. 30% of continuous operation).

Under heavy loading (e.g. continuous operation): Shorter intervals.

Tightening torque

Data	Value	Unit
Tightening torque for screws:	4.5 ... 5.0	Nm

14 Repair

Safety information

- User qualification, mechanical repair: trained and qualified personnel.
- User qualification, electrical repair: electrical technician.



WARNING!

Danger from hazardous substances!

Possible consequence: Fatal or very serious injuries.

Please ensure when handling hazardous substances that you have read the latest safety data sheets provided by the manufacture of the hazardous substance. The actions required are described in the safety data sheet. Check the safety data sheet regularly and replace, if necessary, as the hazard potential of a substance can be re-evaluated at any time based on new findings.

The system operator is responsible for ensuring that these safety data sheets are available and that they are kept up to date, as well as for producing an associated hazard assessment for the workstations affected.

Prior to working on the system:

1. ➤ depressurise the pump.
2. ➤ Use a suitable flushing medium to flush the pump, referring to the material safety data sheet.

14.1 Replacing the diaphragm

The order no. (part number) of the appropriate diaphragm or the spare parts kit can be found at the end of the 'Service' menu.

- Take protective measures, if necessary.
 - Note the material safety data sheet for the feed chemical.
 - Prevent the escape of feed chemical.
 - Ensure that the system is at atmospheric pressure.
1. ➤ Empty the liquid end (turn the liquid end upside down and allow the feed chemical to run out; flush out with a suitable medium; flush the liquid end thoroughly when using hazardous feed chemicals!).
 2. ➤ Set up  → 'Service → Diaphragm replacement → To change position'
 - ⇒ The pump moves the diaphragm away from the backplate.

Now leave the pump connected to the mains/power supply so that this state is maintained.
 3. ➤ Unscrew the hydraulic connectors from the discharge and suction side.
 4. ➤ With types with coarse/fine degassing: Firstly remove the coarse/fine vent valve (grip), then lift off the cover of the liquid end with a screwdriver.

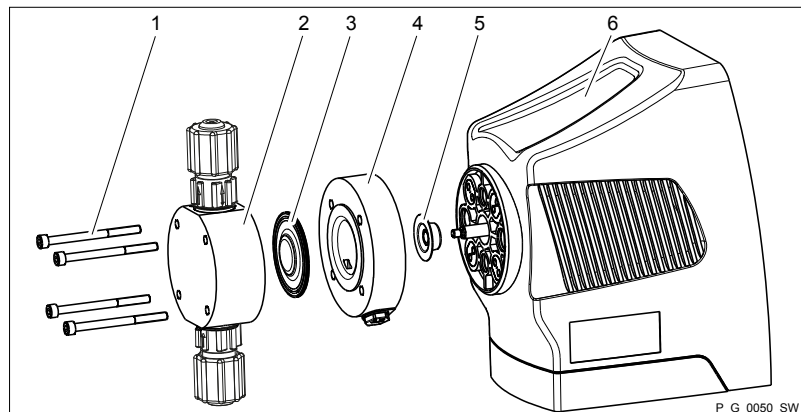



Fig. 40: Partially exploded view of the liquid end

- 1 Screws
 - 2 Dosing head
 - 3 Diaphragm
 - 4 Backplate
 - 5 Safety diaphragm
 - 6 Pump housing
5. ➤ Remove the screws (1).
 6. ➤ Remove the dosing head (2) plus screws (1) from the pump - see figure
 7. ➤ Loosen the diaphragm (3) from the drive axle with a gentle backwards turn in an anticlockwise direction.
 8. ➤ Fully unscrew the diaphragm (3) from the drive axle.
 9. ➤ Remove the backplate (4) from the pump housing (6).
 10. ➤ Check the condition of the safety diaphragm (5) and replace it if necessary.
 11. ➤ Push the safety diaphragm (5) onto the drive axle only until it lies flush with the pump housing (6).

- 12.▶ Tentatively screw the new diaphragm (3) onto the drive axle as far as the stop - ensure that this is successful, otherwise the pump will not subsequently meter precisely.
- 13.▶ Unscrew the diaphragm (3) again.
- 14.▶ Place the backplate (4) onto the pump housing (6).
 - Make sure that the leakage hole points downwards when the pump is in its subsequent fitting position - see figure in the "Maintenance" chapter.
 - Place the backplate (4) immediately into the correct position on the pump housing (6). Do not twist the backplate on the pump housing to ensure that the safety diaphragm (5) does not become warped.
- 15.▶ Place the diaphragm (3) into the backplate (4).
 - Do not over-turn the diaphragm (3) in the following step.
 - Ensure that the backplate (4) remains in its position so that the safety diaphragm does not become warped.
- 16.▶ Hold the backplate (4) firmly and screw the diaphragm (3) clockwise until it is sitting tightly.
- 17.▶ Place the dosing head (2) with the screws (1) onto the diaphragm (3) and the backplate (4) - ensure that the suction connector points downwards when the pump is in its subsequent fitting position.
- 18.▶ Set up  → 'Service → Diaphragm replacement → Back'
 - ⇒ The pump moves the diaphragm back to the backplate.
- 19.▶ Gently tighten the screws (1) and then tighten them cross-wise. See below for the tightening torque  'Tightening torque' on page 103.
- 20.▶ With types with coarse/fine degassing: Allow the cover of the liquid end to lock into the dosing head, then press the grip of the coarse/fine vent valve into the dosing head.

Check the tightening torque of the screws after 24 hours of operation.

Tightening torque

Data	Value	Unit
Tightening torque for screws:	4.5 ... 5.0	Nm

14.1.1 Replacing the vPTFE diaphragm

Spare parts for the vPTFE diaphragm

The vPTFE diaphragm (full PTFE diaphragm) is replaced in the same way as the standard diaphragm - see "Repair" chapter.



A fitted vPTFE diaphragm needs to be replaced once the dosing head screws have been loosened, as the pump will otherwise no longer be tight.

A spare parts kit contains:

- vPTFE diaphragms
- Suction valve
- Discharge valve
- Connector kit
- Seal

Pump type	2.0 diaphragm complete	2.0 spare parts kit PVM	2.0 spare parts kit PVN
1612	1117433	1119828	1119829
1020	1117354	1121492	1121491
0730	1117352	1118459	1118464
0450	1117353	1120526	

14.2 Cleaning the diaphragm rupture indicator

After the diaphragm rupture indicator has been triggered, any residue of feed chemical may affect its function.

- After the diaphragm rupture indicator has been triggered, clean and test it.

1. ➤ First replace the liquid end diaphragm - see above.
2. ➤ Unscrew the diaphragm rupture indicator using an AF 14 open-ended spanner.
3. ➤ Clean the diaphragm rupture indicator with suitable liquid - if possible using water (polysulphone material).
4. ➤ Test the connected diaphragm rupture indicator: fully immerse the tapered section at the front in water.
 - ⇒ The continuous display indicates a diaphragm rupture.
5. ➤ Thoroughly dry the diaphragm rupture indicator.
 - ⇒ The continuous display no longer indicates a diaphragm rupture.
6. ➤ Screw the clean and dry diaphragm rupture indicator into the hole until hand-tight and liquid-tight - without using tools.

14.3 Cleaning valves



Warning of faulty operation

Refer to the exploded drawings in the appendix when working on the unit.

The order no. (part number) of the appropriate spare parts kit can be found at the end of the 'Service' menu.

15 Troubleshooting

Safety information



WARNING!

Warning of hazardous feed chemical

Should a dangerous feed chemical be used: it may escape from the hydraulic components when working on the pump, material failure or incorrect handling of the pump.

- Take appropriate protective measures before working on the pump (e.g. safety glasses, safety gloves, ...). Adhere to the material safety data sheet for the feed chemical.
- Drain and flush the liquid end before working on the pump.



CAUTION!

Warning of feed chemical spraying around

Feed chemical may spray out of the hydraulic components if they are tampered with or opened due to pressure in the liquid end and adjacent parts of the system.

- Disconnect the pump from the mains power supply and ensure that it cannot be switched on again by unauthorised persons.
- Ensure that the system is at atmospheric pressure before commencing any work on hydraulic parts of the system.

15.1 Faults without a fault message

Faults without a fault message

Fault description	Cause	Remedy	Personnel
Pump does not prime in spite of full stroke motion and bleeding.	Minor crystalline deposits on the ball seat due to the valves drying out.	Take the suction hose out of the storage tank and thoroughly flush out the liquid end.	Technical personnel
	Serious crystalline deposits on the ball seat due to the valves drying out.	Dismantle the valves and clean them - refer to the "Repair" chapter.	Technical personnel
Fluid escapes from the backplate.	The screws in the dosing head are too loose.	Tighten the screws in the dosing head crosswise - refer to the "Repair" chapter for the tightening torque.	Instructed personnel
	The metering diaphragm is not leak-tight.	Replace the diaphragm - refer to the "Repair" chapter. If a diaphragm rupture has been indicated, clean the diaphragm rupture indicator - refer to the "Repair" chapter.	Technical personnel
Green LED display (operating indicator) not lighting up.	The wrong power supply or no power supply is connected.	The specified power supply as per the voltage specification can be found on the nameplate.	Electrician

15.2 Faults with error message



15.2.1 Fault messages on the LCD screen

In the event of a fault:

- the red LED display lights up.
- an identifier and a message appear on the LCD screen.
- the pump stops.

Fault description	Cause	Remedy	Personnel
No. 0: The identifier  appears followed by the message 'System error'.	System or EPROM error	Return the pump to ProMinent.	
No. 1: The identifier  appears followed by the message 'Input signal < 4 mA'.	The pump is in 'Analog' operating mode, a fault behaviour has been programmed in the 'Analog' menu and the control current has fallen below 4 mA.	Eliminate the cause of the low control current or Switch the programming of the fault behaviour to 'off' - see chapter "Set up"- "Settings"- "Operating mode"- "Analog".	Technical personnel
No. 2: The identifier  appears followed by the message 'Input signal > 20 mA'.	The pump is in 'Analog' operating mode, a fault behaviour has been programmed in the 'Analog' menu and the control current has risen above 20 mA.	Eliminate the cause of the high control current or Switch the programming of the fault behaviour to 'off' - see chapter "Set up"- "Settings"- "Operating mode"- "Analog".	Technical personnel
No. 3: The identifier  appears followed by the message 'Level error!'.	The fluid level in the storage tank has reached "Liquid level low 2nd stage".	Top up the storage tank.	Technical personnel
No. 4: The identifier  appears followed by the message 'Diaphragm rupture'.	The diaphragm is broken.	Replace the diaphragm and clean the diaphragm rupture indicator, refer to the "Repair" chapter.	Technical personnel
No. 5: The identifier  appears followed by the message 'Defective stroke met.'.	The metering monitor reported more defective strokes than was set in the 'Inputs/Outputs' menu.	Press the [Clickwheel]. Investigate and clear the cause.	Technical personnel
No. 6: The identifier  appears followed by the message 'Sensor error'.	Sensor faulty	Return the pump to ProMinent.	
No. 7: The identifier  "Temperature" appears followed by the message 'Temperature' and the pump remains idle.	The ambient temperature is too high or too low.	Change the ambient temperature. The pump starts up automatically.	Technical personnel
	The temperature is too high.	Rectify the cause. The pump starts up automatically.	Technical personnel
No. 8: No identifier appears but the message 'Initialisation' appears.	Pump restart, initialisations incomplete.	Pump restart.	
No. 9: The identifier  appears followed by the message 'Solenoid not connected'.	The solenoid is not connected.	Return the pump to ProMinent.	
No. 10: The identifier  appears followed by the message 'Parameter wrong!'.	An incorrect parameter has been entered.	Correct the parameter.	Technical personnel









Fault description	Cause	Remedy	Personnel
No. 11: The identifier  and the message 'Overload' appear.	The pump has detected too high a back pressure.	Rectify the cause and acknowledge the error.	Technical personnel
No. 12: The identifier  and the message 'Overload' appear.	The current is too high.	Rectify the cause and acknowledge the error.	Technical personnel
No. 13: The identifier  and the message 'Power supply' appear.	The power supply is too high or too low or not connected.	Rectify the cause.	Technical personnel
No. 14: The identifier  appears followed by the message 'Air in dosinghead'.	Gas bubbles in the liquid end (leaks, gaseous medium, cavitation).	Bleed the liquid end and rectify the cause. Acknowledge the error. Seal the system or slow the suction stroke.	Technical personnel
No. 15: The identifier  appears followed by the message 'Degassing unsuccessful'.	Automatic bleeding was unsuccessful	Rectify the causes and acknowledge the error.	Technical personnel
No. 16: The identifier  and the message 'Memory overflow' appear.	The stroke tank has overflowed.	Remedy the cause (such as too low a factor, too high a contact frequency ...), then: Press the [Clickwheel] (think of the consequences for the process!).	Technical personnel
No. 17: The identifier  and the message 'Control signal < Imin' appear.	The pump is in 'Analog'-'xx. side band" operating mode, a fault behaviour has been programmed in the 'Analog' menu and the control current has fallen below 4 mA (limit can be adjusted).	Eliminate the cause of the low control current or Switch the programming of the fault behaviour to 'off' - see chapter "Set up"-"Settings"-"Operating mode"-"Analog".	Technical personnel
No. 18: The identifier  and the message 'Control signal > Imax' appear.	The pump is in 'Analog'-'xx. side band" operating mode, a fault behaviour has been programmed in the 'Analog' menu and the control current has risen above 20 mA (limit can be adjusted).	Eliminate the cause of the high control current or Switch the programming of the fault behaviour to 'off' - see chapter "Set up"-"Settings"-"Operating mode"-"Analog".	Technical personnel
No. 20: The identifier  and the message 'Module missing' appear.	The optional module is missing.	Insert the optional module.	Technical personnel
	Communication between the optional module and pump electronics is not working.	Return the pump to ProMinent.	
No. 21: The identifier  and the message 'Module communication' appear.	The bus contact between the optional module and control room has been disconnected.	Rectify the cause (cable, control room ...)	Technical personnel
No. 22: The identifier  and the message 'Internal CAN-bus' appear.	The associated heartbeat message was no longer received by the power assembly or the control part for a certain period of time.	Rectify the cause.	Technical personnel

Fault description	Cause	Remedy	Personnel
No. 23: The identifier  and the message 'Error versions' appear.	The version of the "Control unit" firmware is not compatible with the "Power unit" firmware and / or the "HMI data" version.	Return the pump to ProMinent.	Technical personnel
No. 24: The identifier  and the message 'System error' appear.	There is a system or an EEPROM error.	Return the pump to ProMinent.	Technical personnel
No. 25: No identifier appears but the message 'Initialisation' appears.	Initialisations are incomplete after a pump restart.	Restart the pump.	Technical personnel

15.2.2 Warning messages on the LCD screen

In the event of a warning:

- the yellow LED display lights up!
- an identifier and a message appear on the LCD screen.

Fault description	Cause	Remedy	Personnel
No. 0: 'Level' and the identifier  appear.	The fluid level in the storage tank has reached "Liquid level low 1st stage".	Top up the storage tank.	Instructed personnel
No. 1: The identifier  appears followed by the message 'Diaphragm rupture'.	The diaphragm is broken.	Replace the diaphragm and clean the diaphragm rupture indicator, refer to the "Repair" chapter.	Technical personnel
No. 2: The identifier  appears followed by the message 'Defective stroke met.'.	The metering monitor reported more defective strokes than was set in the 'Inputs/Outputs' menu.	Press the [Clickwheel]. Investigate and clear the cause.	Technical personnel
No. 3: The identifier  and the message 'Invalid metering volume' appear.	The set metering volume in concentration mode cannot be metered.	Adjust the metering parameters.	Technical personnel
No. 4: The identifier  and the message 'Invalid parameter' appear.	A set parameter is invalid.	Adjust the parameter.	Technical personnel
No. 5: The identifier  and the message 'Fan warning' appear.	The fan is faulty or not connected.	Return the pump to ProMinent.	
No. 6: The identifier  appears followed by the message 'System warning'.	An internal system warning or an incorrect solenoid assignment has been detected.	Return the pump to ProMinent.	
No. 7: The identifier  appears followed by the message 'Air in dosinghead'.	Gas bubbles in the liquid end (leaks, gaseous medium, ...)	Bleed the liquid end and rectify the cause. Seal the system or slow the suction stroke.	Technical personnel
No. 8: The identifier  and the message 'Overload' appear.	The pump has detected too high a back pressure.	Rectify the cause.	Technical personnel

Fault description	Cause	Remedy	Personnel
No. 10: The identifier P- and the message 'Negative pressure' appear.	The pump has detected too low a back pressure.	Rectify the cause.	Technical personnel
No. 11: The identifier P appears followed by the message 'Cavitation'.	Cavitation in the liquid end.	Adjust the metering parameters.	Technical personnel

15.2.3 All other faults

Please contact the responsible ProMinent branch or representative!

15.3 Log book

15.3.1 Fault messages in the log book



For more information on the 'ERROR' messages - refer to the chapter "Fault messages on the LCD screen".

Tab. 24: Errors

Log book no.	Description	Acknowledge?
0	System, EEPROM error *	X
1	The pump is in 'Analog' operating mode, a fault behaviour has been programmed in the 'Analog' menu and the control current has fallen below 4 mA.	-
2	The pump is in 'Analog' operating mode, a fault behaviour has been programmed in the 'Analog' menu and the control current has risen above 20 mA.	-
3	The fluid level in the storage tank has reached "Level error".	-
4	The diaphragm is broken.	-
5	The metering monitor reports more defective strokes than were set in the 'Inputs/Outputs' menu.	X
6	Fault on the sensor for the stroke length.*	-
7	The ambient temperature is too high or too low. The temperature is too high.	-
9	Fault on the solenoid. *	-
10	An incorrect parameter has been entered.	-
11	The pump has detected too high a back pressure.	X
12	The power supply is too high.	X
13	The power supply is too low or not connected.	-
14	Gas bubbles in the liquid end (leaks, gaseous medium, cavitation).	X

Log book no.	Description	Acknowledge?
15	Automatic bleeding was unsuccessful.	X
16	The stroke tank has overflowed.	X
17	The pump is in 'Analog'-"xx. side band" operating mode, a fault behaviour has been programmed in the 'Analog' menu and the control current has fallen below 4 mA.	-
18	The pump is in 'Analog'-"xx. side band" operating mode, a fault behaviour has been programmed in the 'Analog' menu and the control current has risen above 20 mA.	-
19	The pump has detected too low a back pressure.	X
20	The optional module is missing. Communication between the optional module and pump electronics is not working. *	-
21	The bus contact between the optional module and control room has been disconnected.	-
22	The associated heartbeat message was no longer received by the power unit for a certain period of time (power unit no longer reached?)	-
23	Error versions *	-

* Please get in touch with the ProMinent head office should this fault occur.

15.3.2 Warning messages in the log book





For more information on the 'WARNING' messages - refer to the chapter "Warning messages on the LCD screen".

Tab. 25: Warnings

Log book no.	Description
0	The fluid level in the storage tank has reached "Liquid level low 1st stage".
1	The diaphragm is broken.
2	The metering monitor reports more defective strokes than were set in the 'Inputs/Outputs' menu.
3	The metering volume cannot be metered.
4	A set parameter is invalid.
5	The fan is faulty or not connected.
6	An internal system warning or an incorrect solenoid assignment has been detected.
7	Gas bubbles in the liquid end (leaks, gaseous medium, cavitation).
8	The pump has detected too high a back pressure.
9	The pump cannot meter the capacity it has calculated from the settings.
10	The pump has detected too low a back pressure.
11	Cavitation in the liquid end.

15.3.3 Event messages in the log book

Tab. 26: Events

Log book no.	Description
0	Head change is active – dongle was inserted.
1	Parameter menu called up – dongle was inserted.
2	Air gap measured – dongle was inserted.
3	Too high current was detected but no fault message generated.
5	Automatic bleed was active.
7	The pump was reset to factory settings.
8	The pump was calibrated.
9	 [START/STOP] was pressed.
10	 [Priming] was pressed.
11	The [Clickwheel] was pressed.
12	The diaphragm was replaced.
13	The timer has performed an action.
15	Solenoid identification was performed.
16	A CRC error has been detected in the EEPROM data. Log book: [hh ll 00 00] hh – MSB address ll – LSB address [00 00 rr ss] ss – Struct rr – Result
17	Overloading has been detected. <i>Log book:</i> [00 PP zz ii] PP – Solenoid power [W] zz – Uzk [V] ii – Solenoid current [* 100 mA]
18	The metering volume cannot be metered. In 'Contact' operating mode, e.g. by too fast a contact sequence.
19	The pump has been booted and is operational.
21	An SDO request to the power unit was unsuccessful. Explanatory data: [01 00 00 00] – When reading the maximum capacity [02 00 00 00] – When reading the maximum volume per stroke [04 00 00 00] – When reading the minimum possible volume per stroke [08 00 00 00] – When reading a standard SDO request

15.3.4 Log book entry - Detailed view

Press the *[Clickwheel]* to obtain more information about a log book entry.

Tab. 27: Information on the detailed view

Line	Information
1	Date/time
2	Type of entry (fault, warning ...)
3	Total operating time, total number of strokes
4	Switching-on duration, stroke rate since switching on
5	Room temperature, status information on the error (for developers)

16 Decommissioning and disposal

Decommissioning



WARNING!

Danger from chemical residue

There is normally chemical residue in the liquid end and on the housing after operation. This chemical residue could be hazardous to people.

- It is mandatory that the safety information in the "Storage, transport and unpacking" chapter is read before shipping or transport.
- Thoroughly clean the liquid end and the housing of chemicals and dirt. Adhere to the material safety data sheet for the feed chemical.



WARNING!

Warning of hazardous feed chemical

Should a dangerous feed chemical be used: it may escape from the hydraulic components when working on the pump, material failure or incorrect handling of the pump.

- Take appropriate protective measures before working on the pump (e.g. safety glasses, safety gloves, ...). Adhere to the material safety data sheet for the feed chemical.
- Drain and flush the liquid end before working on the pump.



CAUTION!

Warning of feed chemical spraying around

Feed chemical may spray out of the hydraulic components if they are tampered with or opened due to pressure in the liquid end and adjacent parts of the system.

- Disconnect the pump from the mains power supply and ensure that it cannot be switched on again by unauthorised persons.
- Ensure that the system is at atmospheric pressure before commencing any work on hydraulic parts of the system.



Danger of damage to the unit

Take into account the information in the "Storage, transport and unpacking" chapter if the system is decommissioned for a temporary period.

1. ➤ Disconnect the pump from the mains/power supply.
2. ➤ Drain the liquid end by turning the pump upside down and allowing the feed chemical to run out.
3. ➤ Flush the liquid end with a suitable medium; flush the dosing head thoroughly when using hazardous feed chemicals!

Disposal



WARNING!

Eye injury from compression spring

A compression spring is fitted in the pump in the drive magnet, which could cause eye injuries when opened.

- Do not dismantle the pump to dispose of it.



CAUTION!

Risk to the environment from the battery

There is a battery in the pump, which can have a toxic effect on the environment.

- Disconnect the battery from the remaining parts.
- Note the pertinent regulations currently applicable in your country!



CAUTION!

Environmental hazard due to electronic waste

There are components in the pump, which can have a toxic effect on the environment.

- Note the pertinent regulations currently applicable in your country!

17 Technical data

17.1 Performance data

Tab. 28: At 200 strokes/minute and 100% stroke length

Liquid end type	Minimum pump capacity			Max. stroke rate	Connector size outer Ø x inner Ø	Suction lift*	Priming lift	Max. priming pressure on the suction side ¹	Weight
	bar	l/h	ml/stroke						
2508	25	7.5	0.63	200	8x4 / 6x4	5	3.5 / 3.0	12.5	11 ² / 10
1608	16	7.8	0.65	200	8x5 / 8x7	5	3.5 / 3.0	8	11 ² / 10
1612	16	12.0	1.00	200	8x5 / 8x7	6	3.0 / 2.5	8	11 ² / 10
1020	10	19.6	1.63	200	12x9 / 12x10	5	3.5 / 3.0	5	11 ² / 10 10 / 11 ²
0730	7	29.4	2.40	200	12x9 / 12x10	5	4.0 / 3.5	3.5	11 ² / 10
0450	4	49.0	4.08	200	DN 10	3	2.5 / 2.5	2	11 ² / 10
0280	2	78.5	6.54	200	DN 10	2	3.0 / 3.0	1	11 ² / 10

Design with self-degassing dosing head without bypass**

1608	16	7.0	0.60	200	8x5	3	3.0	8	10
1612	16	10.0	0.80	200	8x5	2	1.4	8	10
1020	10	15.0	1.25	200	12x9	2	1.5	5	10
0730	7	27.5	2.30	200	12x9	2	1.6	3.5	10

* Suction lift with a filled suction line and filled liquid end

** The performance data stated represents guaranteed minimum values, calculated using water as the medium at room temperature.

¹ If the pump is fitted with an SER head and priming pressure is being applied, then the pump may only be operated in Automatic OFF mode.

² With stainless steel design

Metering pumps with dosing heads for higher-viscosity media (HV) have a 10 ... 20% lower dosing rate and are not self-priming. Connector G 3/4-DN 10 with hose sleeve d16-DN10.

Design of connectors

Material	Connector	Design
Plastic	8 ... 12 mm	Hose squeeze connector
	DN 10	d16 DN 10 hose sleeve
Stainless steel	6 ... 12 mm	Swagelok® system
	DN 10	Rp 3/8 insert

17.1.1 Performance data with vPTFE diaphragm

Tab. 29: at 200 strokes/minute and 100% stroke length

Type	Pump capacity at maximum back pressure			Connector size outer Ø x inner Ø	Suction lift*	Priming lift**	Max. priming pressure on the suction side
	bar	l/h	ml/stroke				
1612	10	12.0	1.00	8x5	5.0	2.5	5
1020	10	17.7	1.50	12x9	4.0	2.5	5
0730	7	26.7	2.23	12x9	4.0	2.5	3
0450	4	45.0	3.75	DN10	2.0	2.0	2

The stated performance data represents minimum values calculated using water as the medium at 20 °C.

* Suction lift with a filled suction line and filled liquid end.

** Priming lifts with clean and moist valves. Priming lift at 100% stroke length and free drain or opened vent valve.

17.2 Accuracy

17.2.1 Standard Liquid End

Data	Value	Unit
Capacity range of the series	-5 ... +10	% *
Reproducibility	±2	% **

* - at max. stroke length and max. operating pressure for all material versions

** - at constant conditions and min. 30 % stroke length

17.2.2 Self-Bleeding Liquid End

As the self-bleeding liquid end is used with outgassing media and when operating with air bubbles, no dosing accuracy or reproducibility can be provided.

The recommended minimum stroke length with self-bleeding dosing pumps is 50 %.

17.3 Viscosity

Tab. 30: The liquid ends are suitable for the following viscosity ranges:

Design	Viscosity in mPas
Standard	0 ... 200
With valve springs	201 ... 500
With HV head	501 ... 3000*
Self-degassing (SEK)	0 ... 50

* Even significantly higher with correctly adjusted installation. Contact Technical Support in Heidelberg.

Tab. 31: General information on selection according to viscosity.

Viscosity in mPas	Options	Stroke rate (strokes/minute)
0 ... 200	No specific options required	Any stroke rate.
201 ... 500	Valves fitted with springs	HV1 mode: Stroke rate max. 160 strokes/minute.
501 ... 1000	Valves fitted with springs. HV head recommended. A positive flow is required. Stroke length >75%.	HV 2 mode: Stroke rate max. 120 strokes/minute.
1001 ... 3000	Select an HV head. Valves fitted with springs. A positive flow is required. Stroke length >75%.	HV 3 mode: Stroke rate max. 80 strokes/minute.
> 3000	Contact Customer Service to select a suitable pump.	

17.4 Material specifications

Liquid ends

Design	Dosing head	Suction/pressure connector	Ball seat	Seals	Valve balls
NPT	Clear acrylic	PVDF	PVDF	PTFE	Ceramic
PVT	PVDF	PVDF	PVDF	PTFE	Ceramic
SST (8-12 mm)	Stainless steel 1.4404	Stainless steel 1.4404	Ceramic	PTFE	Ceramic
SST (DN10)	Stainless steel 1.4404	Stainless steel 1.4404	PTFE with carbon	PTFE	Ceramic

Diaphragm with PTFE coating.

Pump

Design	Housing	Hood	Transparent cover	Electronics
all	Polyphenyl ether (PPE with fibre-glass)	Polyphenyl ether (PPE with fibre-glass)	Polycarbonate	Electronic components

17.5 Electrical data

Design: 100 - 230 V \pm 10%, 50/60 Hz

Specification	Value
Nominal power, approx.	78 W
Switch on peak current, (within approx. 50 ms falling prevention)	8 ... 4 A
	T 3.15 A *

* 250 V (1.5kA), Order no. 732414

Fuses must have VDE, UL and CSA certification.

17.6 Temperatures

Pump, fully assembled

Data	Value	Unit
Storage and transport temperature:	-10 ... +50	°C
Ambient temperature in operation (power end/drive and control):	-10 ... +45	°C

Liquid end, long-term*

Data	Value	Unit
Liquid end temperature	-10 ... +40	°C **

* long term at max. operating pressure, dependent on the ambient temperature and the feed chemical temperature

** with PVT and SST: -10 ... +50 °C

Liquid end, short-term*

Material version	Value	Unit
NPT	60	°C
PVT	120	°C
SST	120	°C

* Temp. max., for 15 min at max. 2 bar, dependent on the ambient and feed chemical temperatures

17.7 Climate

Air humidity, max. 95% relative humidity, non-condensing.

Exposure in a humid and changing climate:

FW 24 according to DIN 50016

Wet location

Wet location: No

17.8 Altitude of site

Data	Value	Unit
Altitude of site , max.:	2000	m above NHN

17.9 Degree of protection and safety requirements

Degree of protection Protection against contact and moisture: IP 66 according to DIN EN 60529

Safety requirements Protection class 1 - mains connection with protective conductor

17.10 Compatibility

Some hydraulic parts of the delta[®] are identical to those of the Beta[®] and gamma/ X.

There is substantial compatibility of the following components and accessories to pumps in the product ranges Beta[®] and gamma/ X:

- Control cable gamma/Vario 2-, 4- and 5-wire for the "External" function
- Level switch 2-stage (gamma / Vario / Beta[®])
- Metering line cross-sections
- Standard connector kit for gamma
- Dosing tank
- Overall height (distance between the suction and pressure connector)
- Identical use of accessories, such as back pressure valves, multifunctional valves, dosing monitor and flushing equipment

17.11 Weight

Material version	Weight
	kg
NPT	10
PVT	10
SST	11

17.12 Sound pressure level

Sound pressure level Sound pressure level LpA < 70 dB in accordance with EN ISO 20361:2010-10

at maximum stroke length, maximum stroke rate, maximum back pressure (water)

18 Exploded drawings of the gamma/ XL

You can replace the standard diaphragms 1:1 with vPTFE diaphragms. You simply require a new vPTFE diaphragm.

Liquid end 1608 / 2508 NP_2

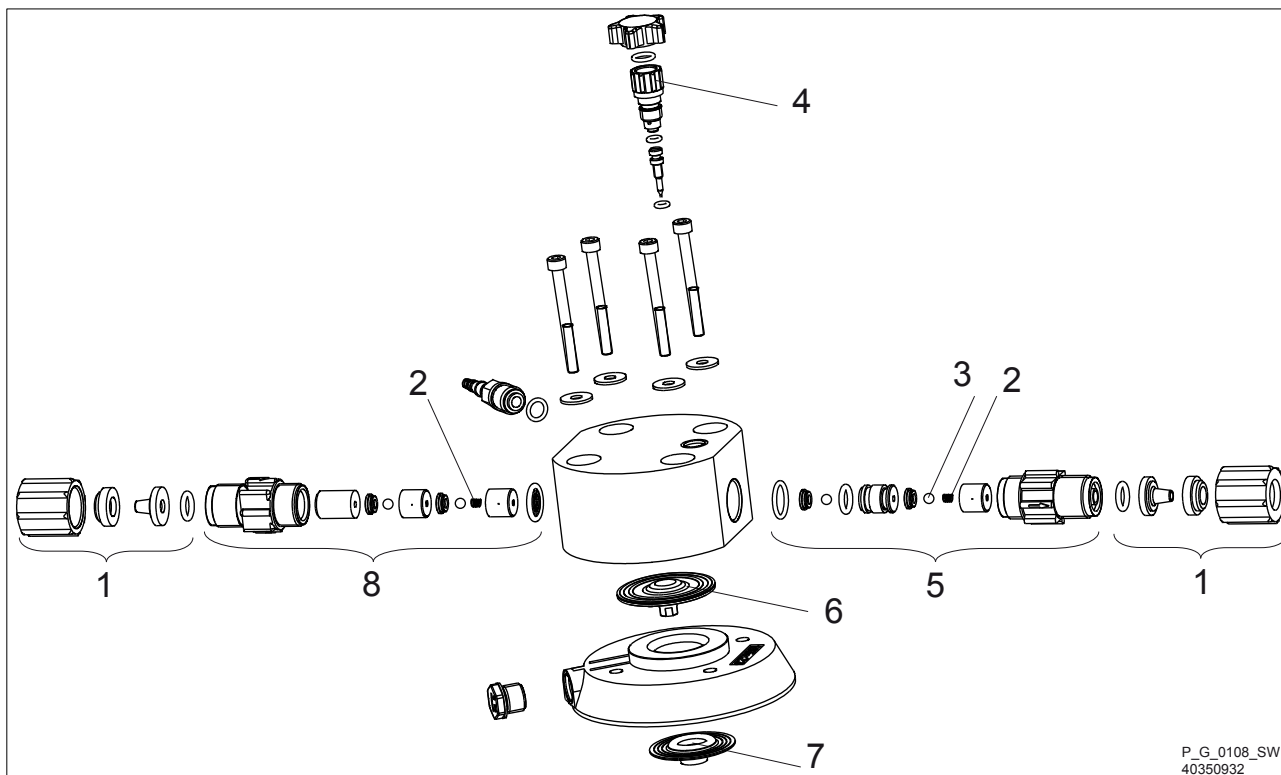

Fig. 41: Liquid end of gamma/ XL 1608 / 2508 NP_2

Tab. 32: Spare parts for liquid end gamma/ XL 1608 / 2508 NP_2

Pos.	Designation
1	Connector kit
5	Discharge valve
6	Diaphragm
8	Suction valve

Liquid end gamma/ XL NPT2

	1608	2508
Liquid end with degassing	1096276	1096277
Spare parts kit	1030225	1095912
Diaphragm	1030353	1030353

Liquid end gamma/ XL NPE2

	1608	2508
Liquid end with degassing	1096278	1096279
Spare parts kit	1030620	1033172
Diaphragm	1030353	1030353

Liquid end gamma/ XL NPB2

	1608	2508
Liquid end with degassing	1096282	1096283
Spare parts kit	1030611	1033171
Diaphragm	1030353	1030353

Liquid end 1612 - 0730 NP_2

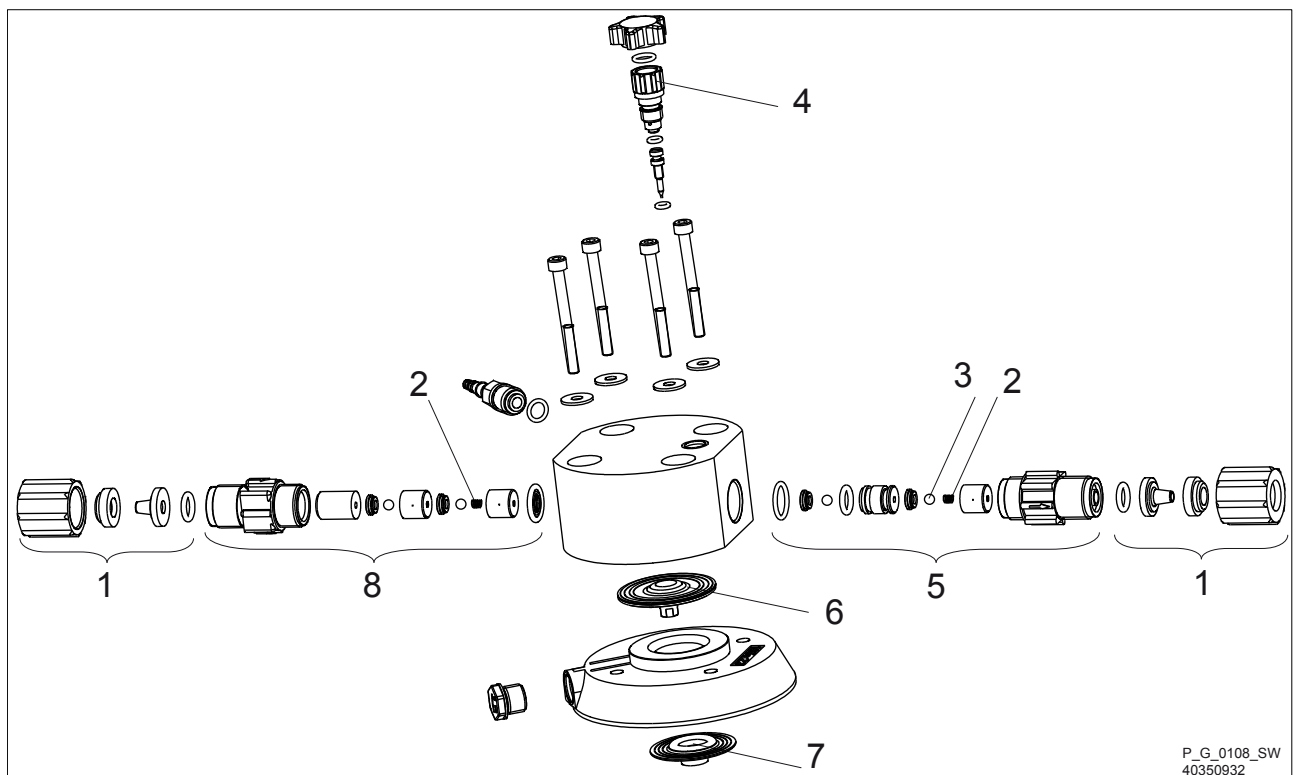

Fig. 42: Liquid end of gamma/ XL 1612 - 0730 NP_2

Tab. 33: Spare parts for liquid end gamma/ XL 1612 - 0730 NP_2

Pos.	Designation
1	Connector kit
5	Discharge valve
6	Diaphragm
8	Suction valve

Liquid end gamma/ XL NPT2

	1612	1020	0730
Liquid end with degassing	1096275	1096273	1096274
Spare parts kit	1027081	1027082	1095626
Diaphragm	1000248	1000249	1045456

Liquid end gamma/ XL NPE2

	1612	1020	0730
Liquid end with degassing	1096270	1096261	1096260
Spare parts kit	1030536	1030537	1030621
Diaphragm	1000248	1000249	1045456

Liquid end gamma/ XL NPB2

	1612	1020	0730
Liquid end with degassing	1096268	1096269	1096263
Spare parts kit	1030525	1030526	1030612
Diaphragm	1000248	1000249	1045456

Liquid end 1608 NPT7 SER

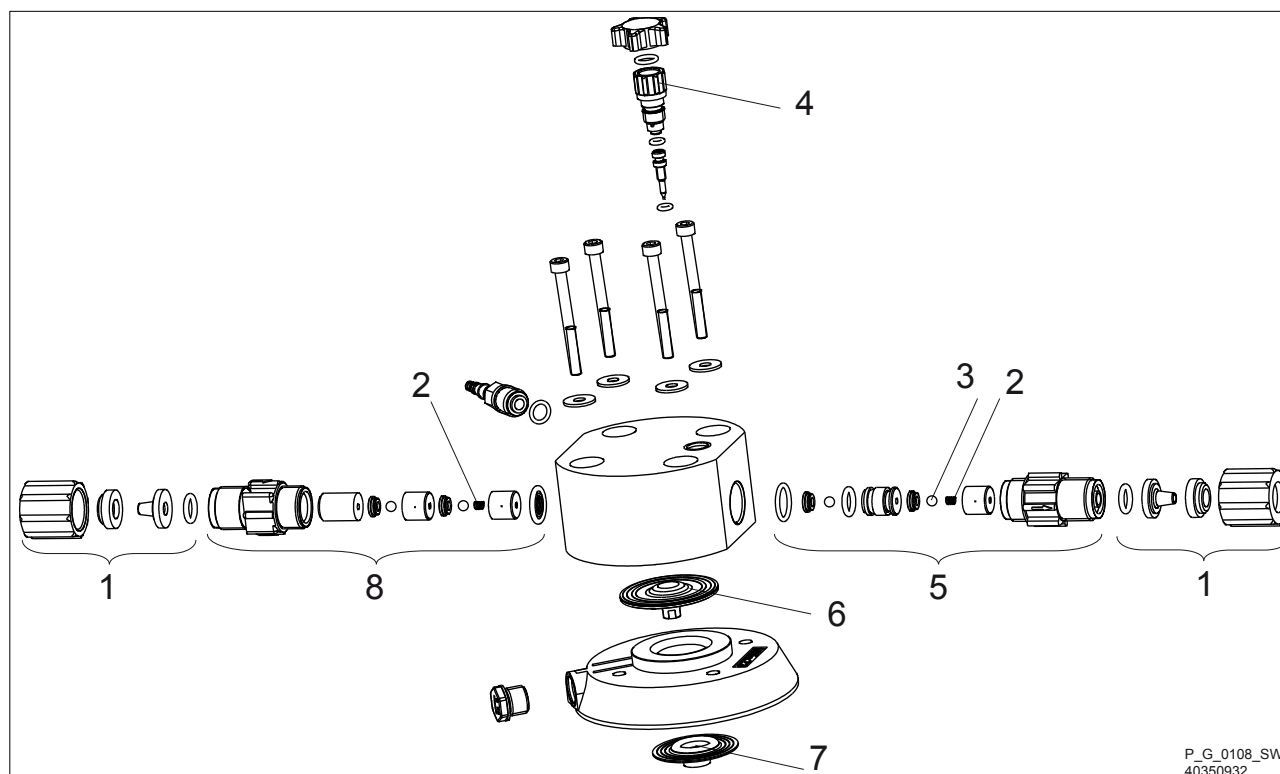

P_G_0108_SW
40350932

Fig. 43: Liquid end of gamma/ XL 1608 NPT7 SER

Tab. 34: Spare parts for liquid end gamma/ XL 1608 NPT7, self-degassing SER

Pos.	Designation
1	Connector kit
5	Discharge valve
6	Diaphragm
8	Suction valve

Liquid end gamma/ XL NPT 7

	1608
Liquid end with degassing	1096271
Spare parts kit	1047831
Diaphragm	1030353

Liquid end 1612 - 0730 NPT7 SER

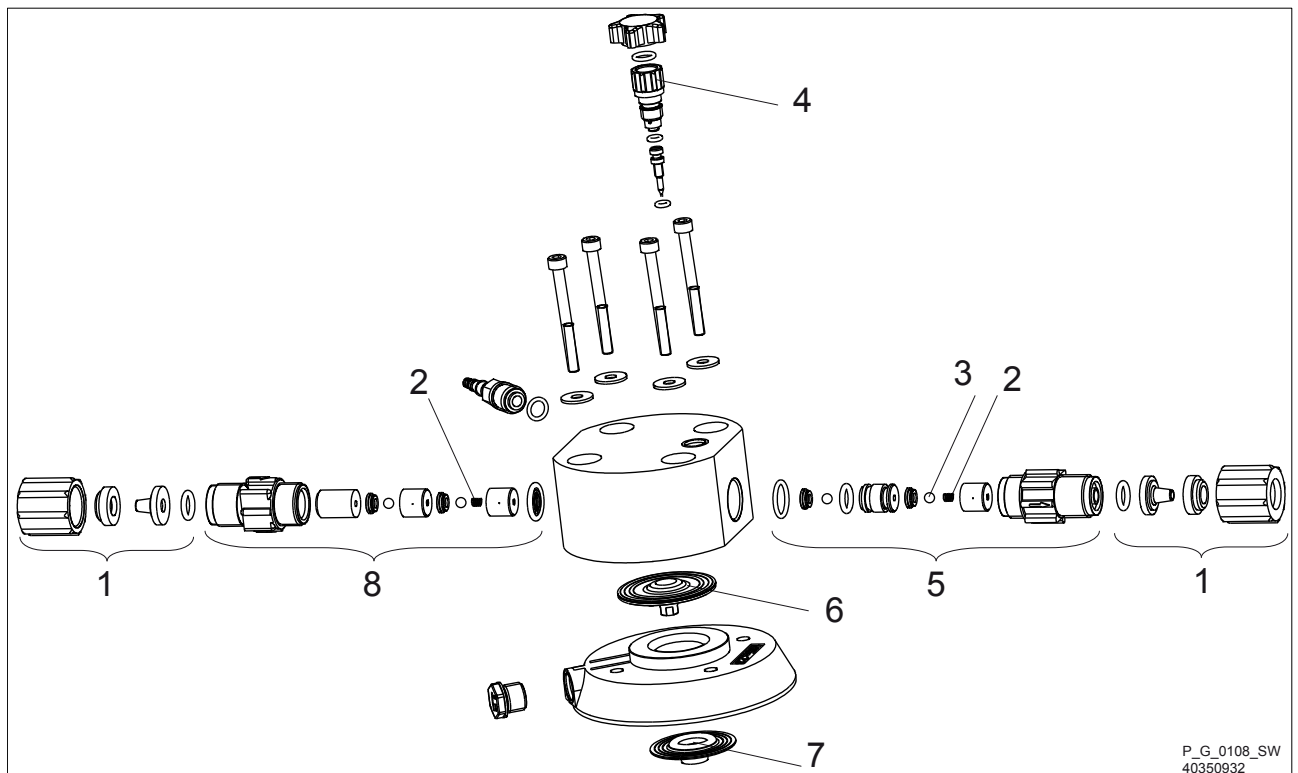

Fig. 44: Liquid end of gamma/ XL 1612 - 0730 NPT7 SER

Tab. 35: Spare parts for liquid end gamma/ XL 1612 - 0730 NPT7, self-degassing SER

Pos.	Designation
1	Connector kit
5	Discharge valve
6	Diaphragm
8	Suction valve

Liquid end gamma/ XL NPT 7

	1612	1020	0730
Liquid end with degassing	1096272	1096266	1096267
Spare parts kit	1047832	1047833	1095503
Diaphragm	1000248	1000249	1045456

Liquid end 1608 / 2508 NP_0

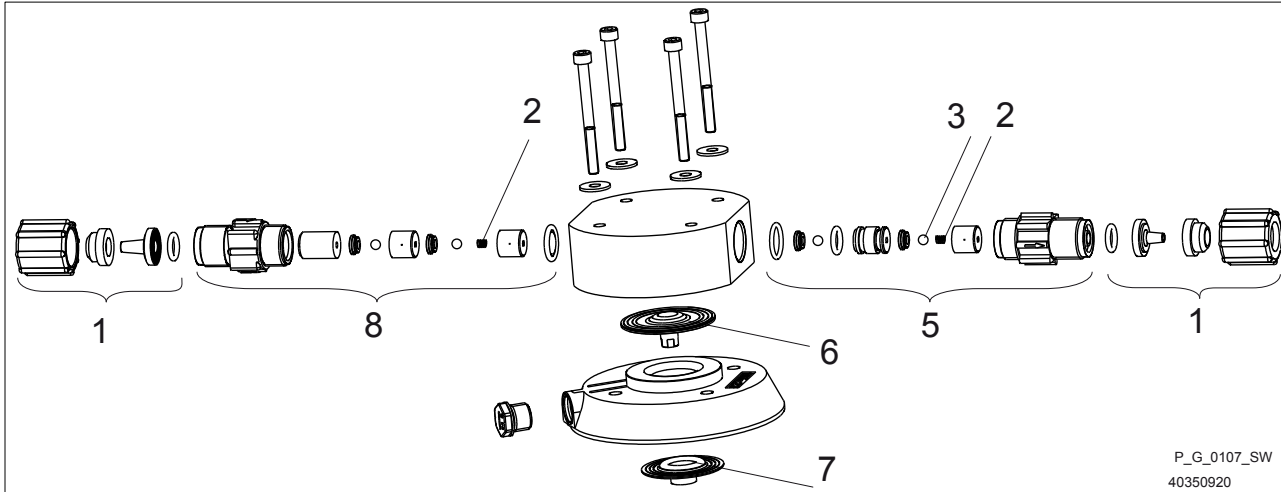

Fig. 45: Liquid end of gamma/ XL 1608 / 2508 NP_0

Tab. 36: Spare parts for liquid end gamma/ XL 1608 / 2508 NP_0

Pos.	Designation
1	Connector kit
5	Discharge valve
6	Diaphragm
8	Suction valve

Liquid end gamma/ XL NPT 0

	1608	2508
Liquid end without degassing	1096217	1096214
Spare parts kit	1030225	1095912
Diaphragm	1030353	1030353

Liquid end gamma/ XL NPE 0

	1608	2508
Liquid end without degassing	1096175	1096216
Spare parts kit	1030620	1033172
Diaphragm	1030353	1030353

Liquid end gamma/ XL NPB 0

	1608	2508
Liquid end without degassing	1096280	1096281
Spare parts kit	1030611	1033171
Diaphragm	1030353	1030353

Liquid end 1612 - 0730 NP_0

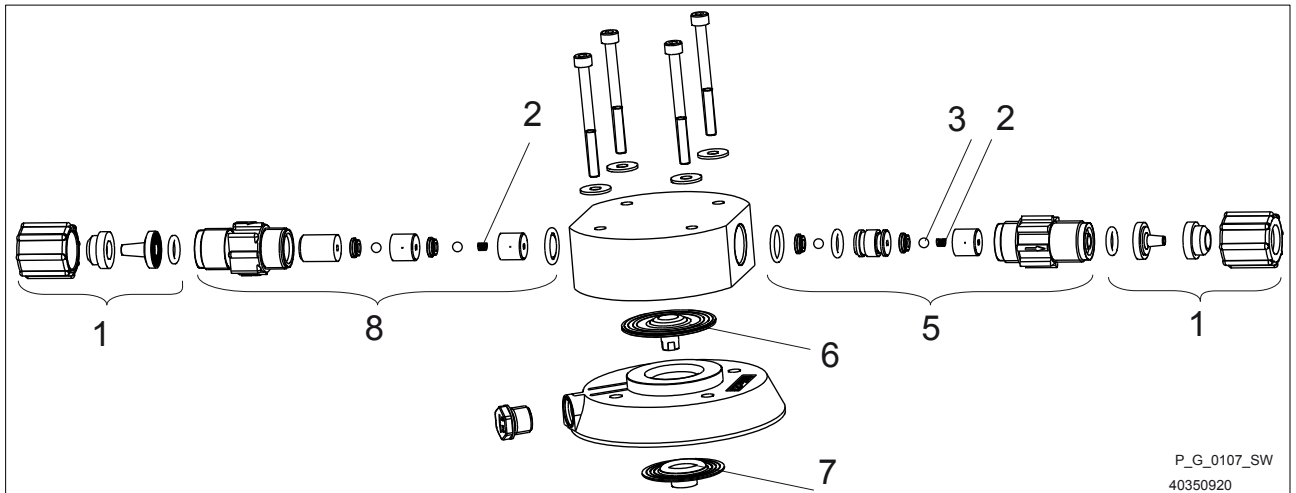

P_G_0107_SW
40350920

Fig. 46: Liquid end of gamma/ XL 1612 - 0730 NP_0

Tab. 37: Spare parts for liquid end gamma/ XL 1612 - 0730 NP_0

Pos.	Designation
1	Connector kit
5	Discharge valve
6	Diaphragm
8	Suction valve

Liquid end gamma/ XL NPT 0

	1612	1020	0730
Liquid end without degassing	1096215	1096182	1096183
Spare parts kit	1027081	1027082	1095626
Diaphragm	1000248	1000249	1045456

Liquid end gamma/ XL NPE 0

	1612	1020	0730
Liquid end without degassing	1096180	1096181	1096178
Spare parts kit	1030536	1030537	1030621
Diaphragm	1000248	1000249	1045456

Liquid end gamma/ XL NPB 0

	1612	1020	0730
Liquid end without degassing	1096284	1096285	1096262
Spare parts kit	1030525	1030526	1030612
Diaphragm	1000248	1000249	1045456

Liquid end 1608 PV_2

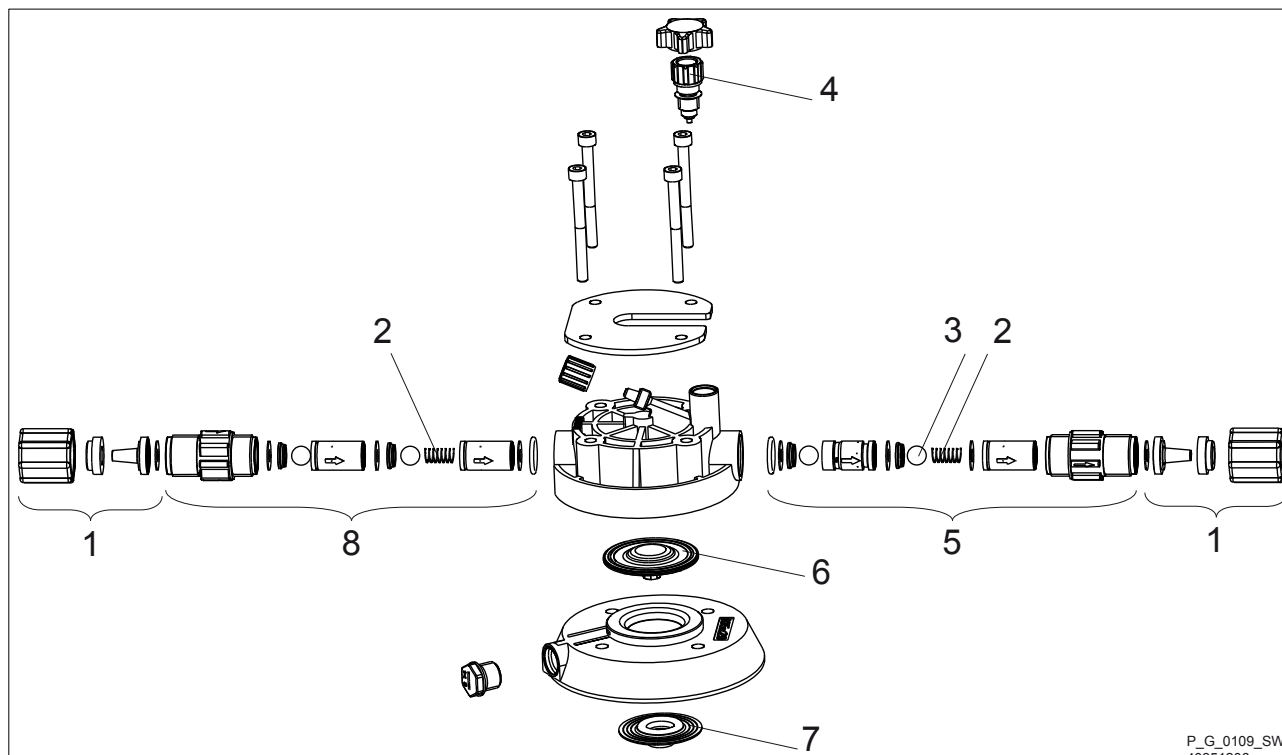

Fig. 47: Liquid end of gamma/ XL 1608 PV_2

Tab. 38: Spare parts for liquid end gamma/ XL 1608 PV_2

Pos.	Designation
1	Connector kit
5	Discharge valve
6	Diaphragm
8	Suction valve

Liquid end gamma/ XL PVT 2

	1608
Liquid end with degassing	1096265
Spare parts kit	1030225
Diaphragm	1030353

Liquid end gamma/ XL PVT 7, SER

	1608
Liquid end, self-degassing SER	1096251
Spare parts kit	1047831
Diaphragm	1030353

Liquid end gamma/ XL PVF2, FDA

	1608
Liquid end with degassing	1096252
Spare parts kit	1083565
Diaphragm	1030353

Liquid end 1612 - 0730 PV_2

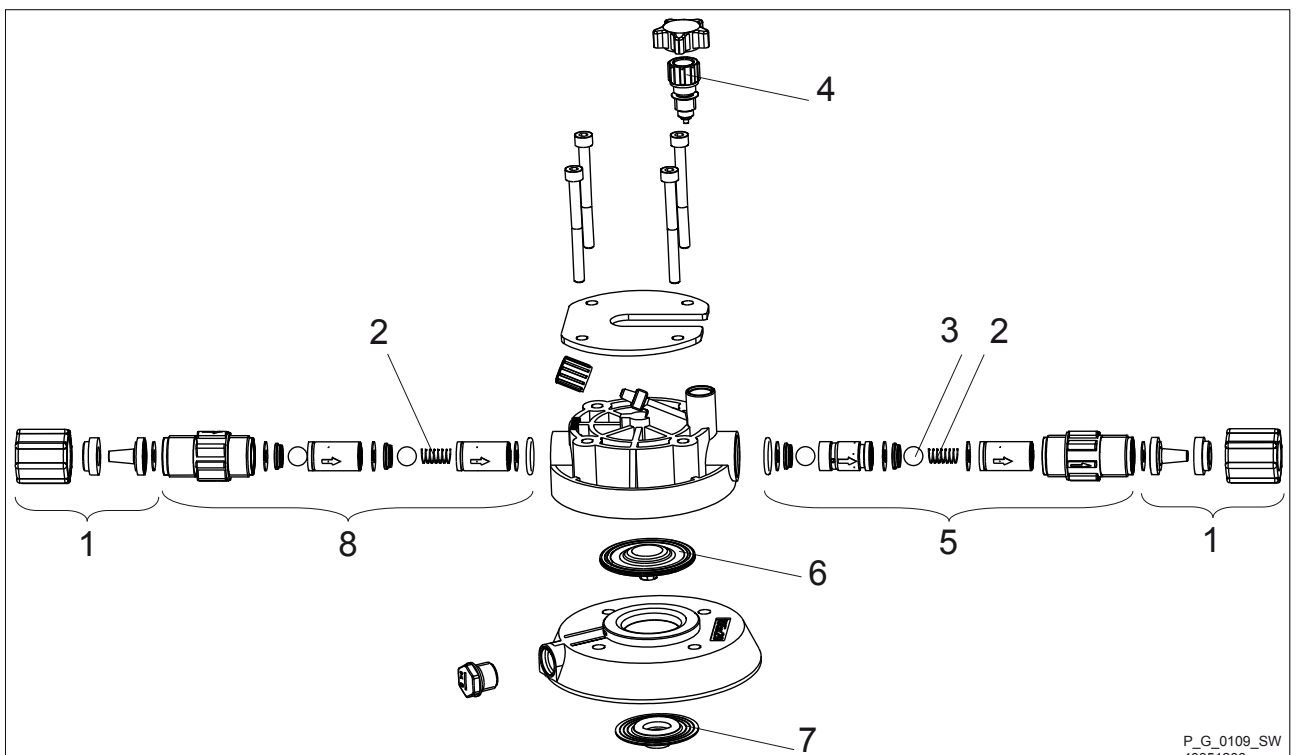

P_G_0109_SW
40351206

Fig. 48: Liquid end of gamma/ XL 1612 - 0730 PV_2

Tab. 39: Spare parts for liquid end gamma/ XL 1612 - 0730 PV_2

Pos.	Designation
1	Connector kit
5	Discharge valve
6	Diaphragm
8	Suction valve

Liquid end gamma/ XL PVT 2

	1612	1020	0730
Liquid end with degassing	1096264	1096258	1096257
Spare parts kit	1027081	1027082	1095626
Diaphragm	1000248	1000249	1045456

Liquid end gamma/ XL PVT 7, SER

	1612	1020	0730
Liquid end, self-degassing SER	1096250	1096249	1096255
Spare parts kit	1047832	1047833	1095503
Diaphragm	1000248	1000249	1045456

Liquid end gamma/ XL PVF2, FDA

	1612	1020	0730
Liquid end with degassing	1096246	1096247	1096248
Spare parts kit	1083569	1083570	1096089
Diaphragm	1000248	1000249	1045456

Liquid end 0450 / 0280 PV_2

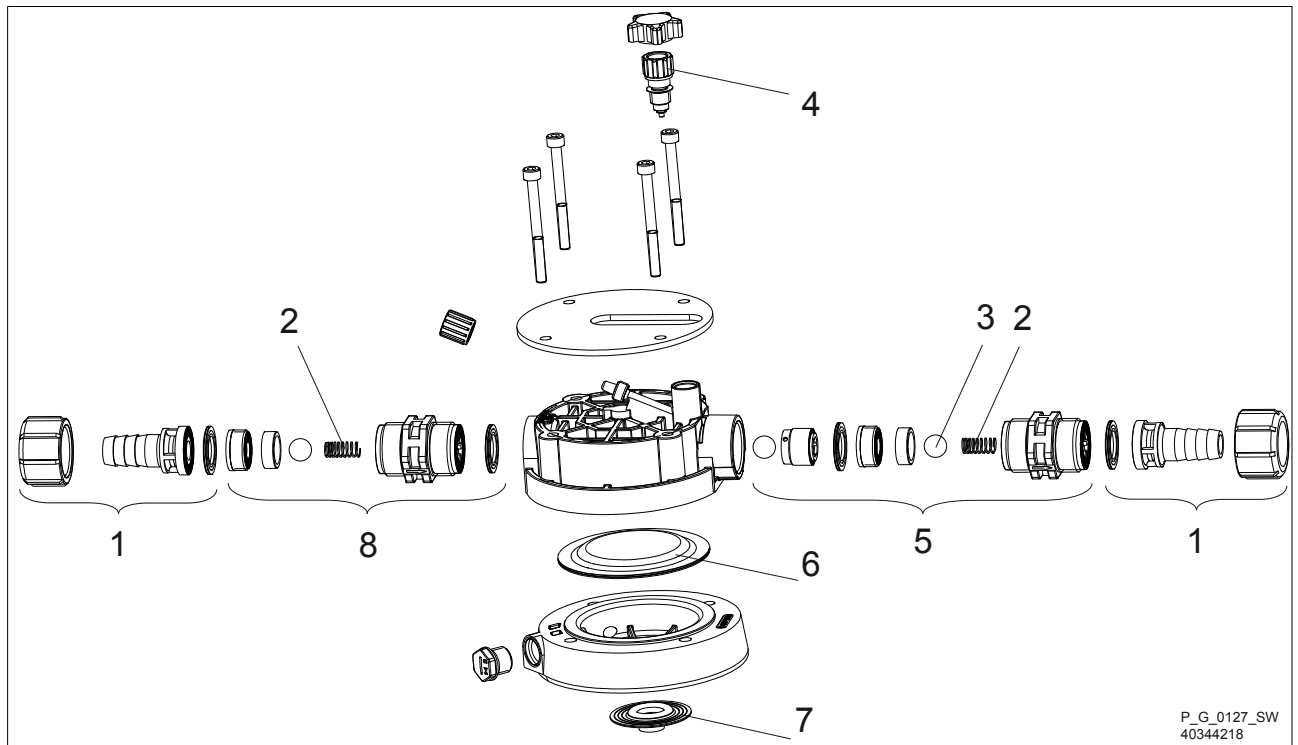

Fig. 49: Liquid end of gamma/ XL 0450 / 0280 PV_2

Tab. 40: Spare parts for liquid end gamma/ XL 0450 / 0280 PV_2

Pos.	Designation
1	Connector kit
5	Discharge valve
6	Diaphragm
8	Suction valve

Liquid end gamma/ XL PVT 2

	0450	0280
Liquid end with degassing	1096254	1096253
Spare parts kit	1095502	1095500
Diaphragm	1045443	1059691

Liquid end gamma/ XL PVF2, FDA

	0450	0280
Liquid end with degassing	1096243	1096242
Spare parts kit	1096090	1096088
Diaphragm	1045443	1059691

Liquid end 1608 / 2508 SST0

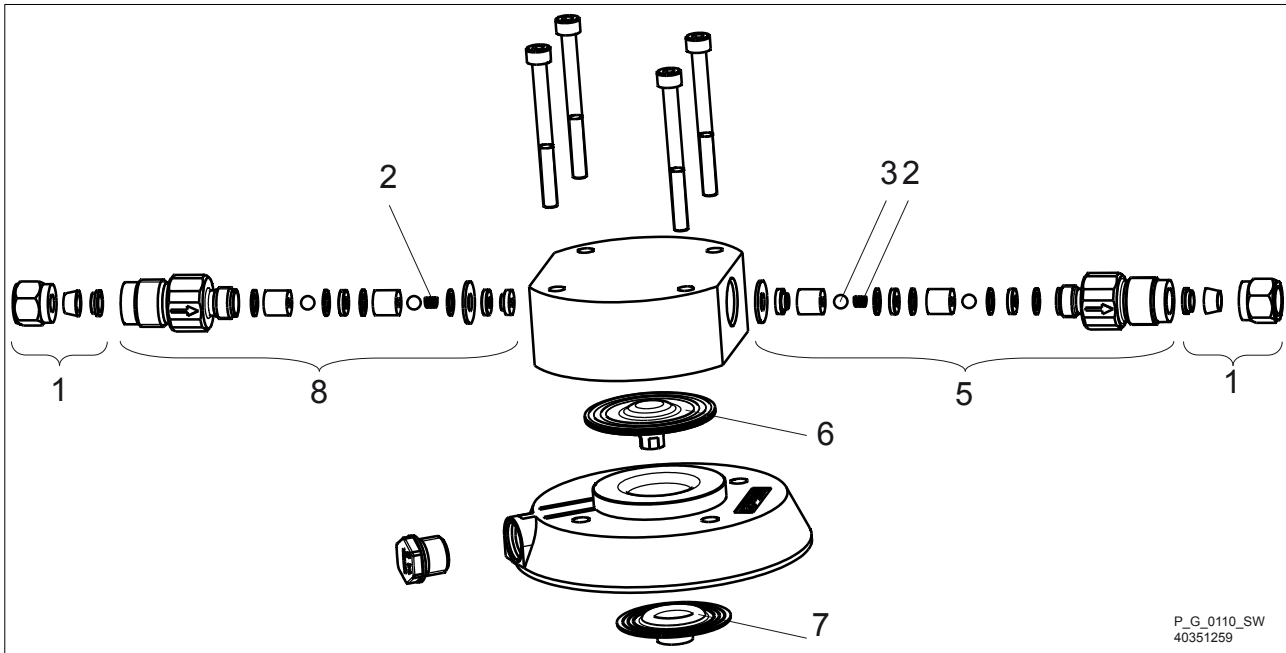

Fig. 50: Liquid end of gamma/ XL 1608 / 2508 SST0

Tab. 41: Spare parts for liquid end gamma/ XL 1608/2508 SST0

Pos.	Designation
1	Connector kit
5	Discharge valve
6	Diaphragm
8	Suction valve

Liquid end gamma/ XL SST 0

	1608	2508
Liquid end without degassing	1096245	1096244
Spare parts kit	1030226	1030226
Diaphragm	1030353	1030353

Liquid end 1612 - 0730 SST0

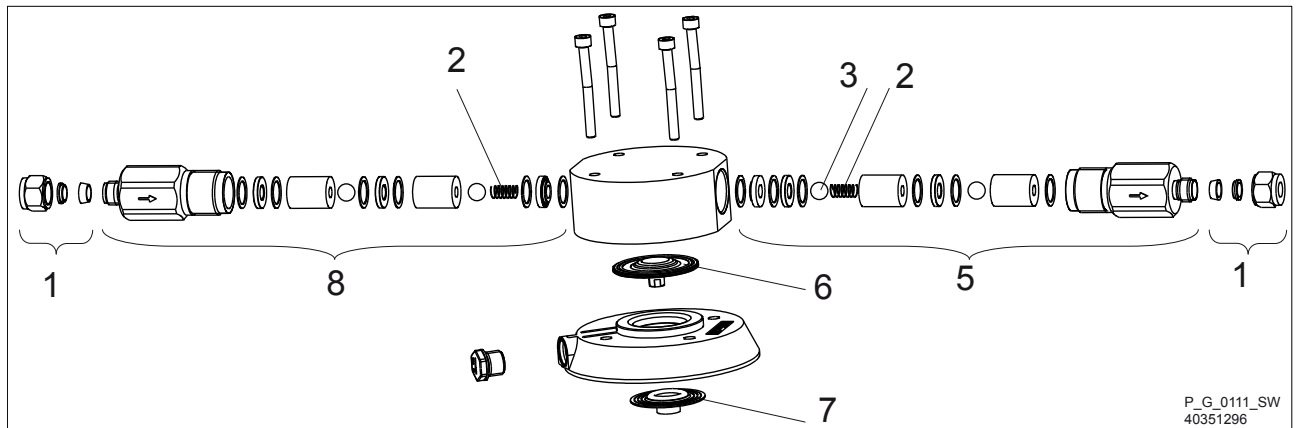

Fig. 51: Liquid end of gamma/ XL 1612 - 0730 SST0

Tab. 42: Spare parts for liquid end gamma/ XL 1612 - 0730 SST0

Pos.	Designation
1	Connector kit
5	Discharge valve
6	Diaphragm
8	Suction valve

Liquid end gamma/ XL SST0

	1612	1020	0730
Liquid end without degassing	1096239	1096236	1096237
Spare parts kit	1027086	1027087	1095501
Diaphragm	1000248	1000249	1045456

Liquid end 0450 - 0280 SST0

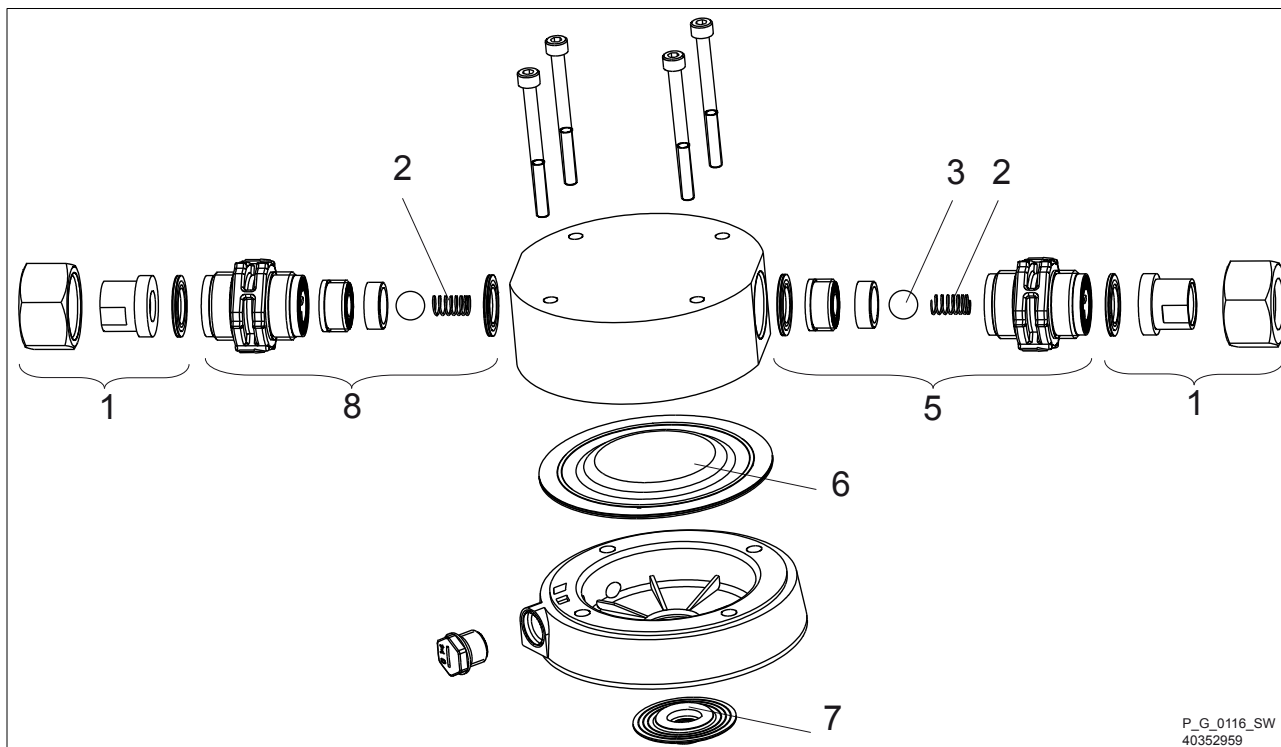

Fig. 52: Liquid end of gamma/ XL 0450 - 0280 SST0

Liquid end gamma/ XL SST0

	0450	0280
Liquid end without degassing	1096218	1096235
Spare parts kit	1095625	1095624
Diaphragm	1045443	1059691

Liquid end gamma/ XL SSF0, FDA

	0450	0280
Liquid end without degassing	1096234	1096223
Spare parts kit	1095625	1095624
Diaphragm	1045443	1059691

Liquid end 1608 / 1612 / 1020 PVT4,
HV

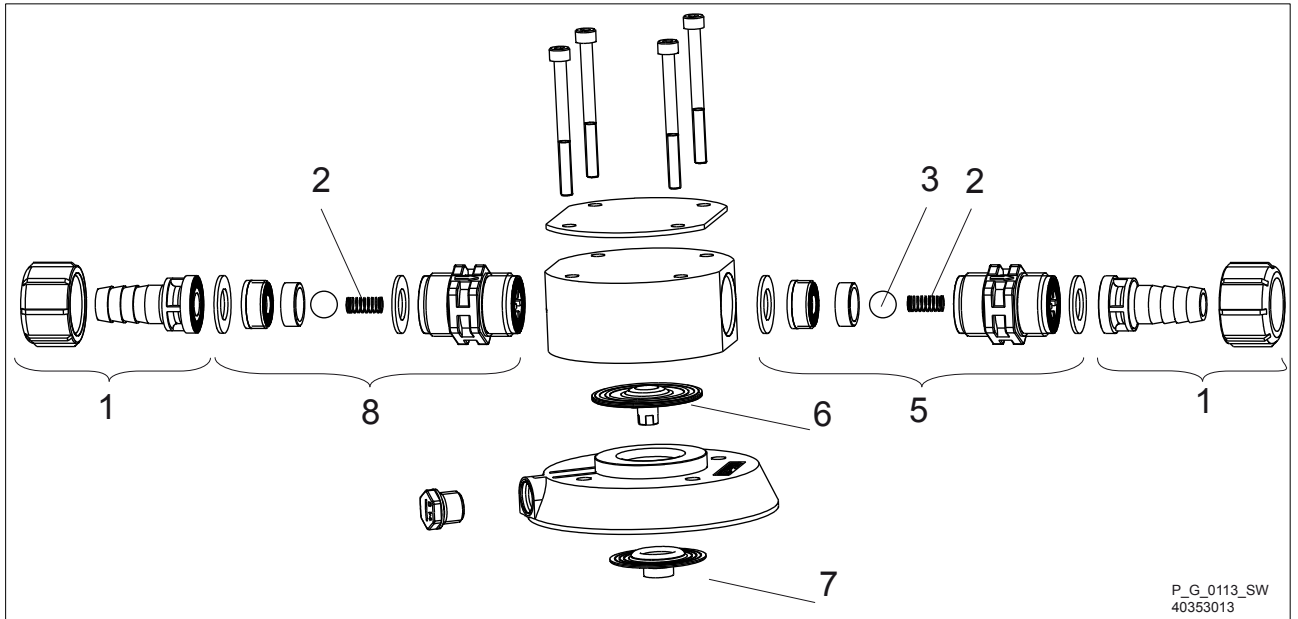

P_G_0113_SW
40353013

Fig. 53: Liquid end gamma/ XL 1608 / 1612 / 1020 PVT4, HV

Tab. 43: Spare parts for liquid end gamma/ XL 1608 / 1612 / 1020 PVT4, HV

Pos.	Designation
1	Connector kit with hose sleeve
6	Diaphragm

Liquid end gamma/ XL PVT4, HV

	1608	1612	1020
Liquid end HV	1096222	1096221	1096220
Spare parts kit	1019066	1019067	1019069
Diaphragm	1030353	1000248	1000249

Liquid end gamma/ XL 0730 PVT4,
HV

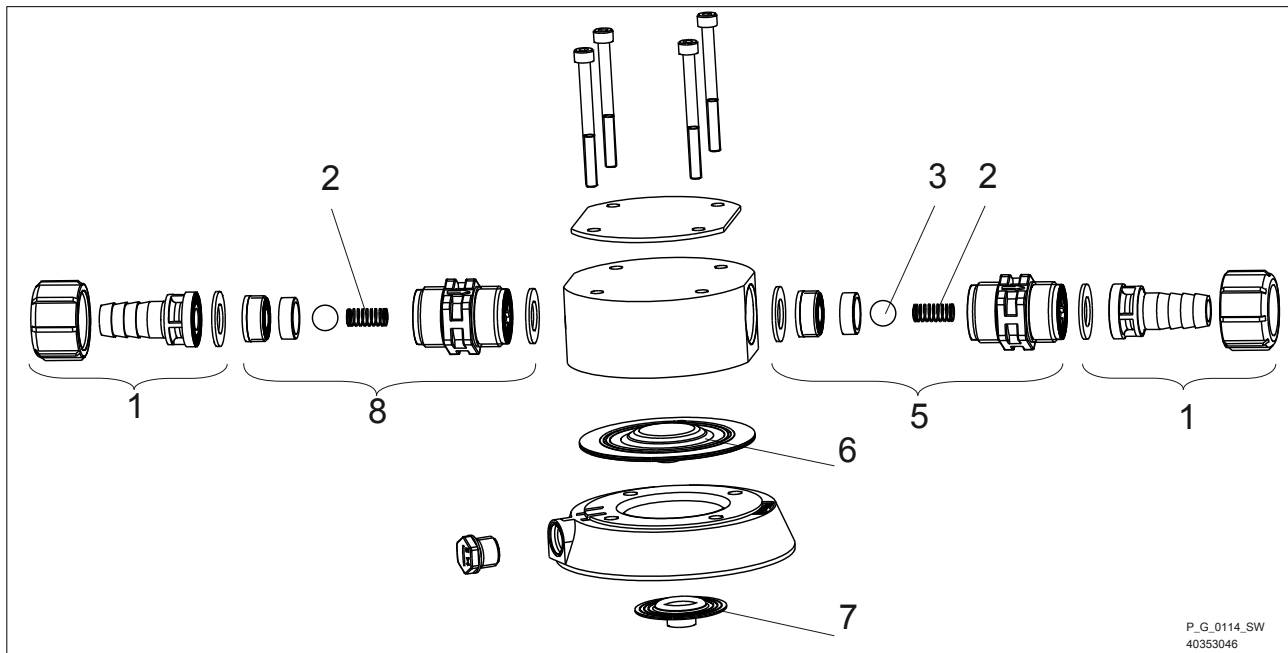

Fig. 54: Liquid end gamma/ XL 0730 PVT4, HV

Tab. 44: Spare parts for liquid end gamma/ XL 0730 PVT4, HV

Pos.	Designation
1	Connector kit with hose sleeve
6	Diaphragm

Liquid end gamma/ XL 0730 PVT4,
HV

	0730
Liquid end HV	1096219
Spare parts kit	1095499
Diaphragm	1045456

19 Dimensional drawings

i – Compare the dimensions on the dimensional drawing with those of the pump.
 – All dimensions are in mm.

Dimensional drawing gamma/ XL,
 material versions NP

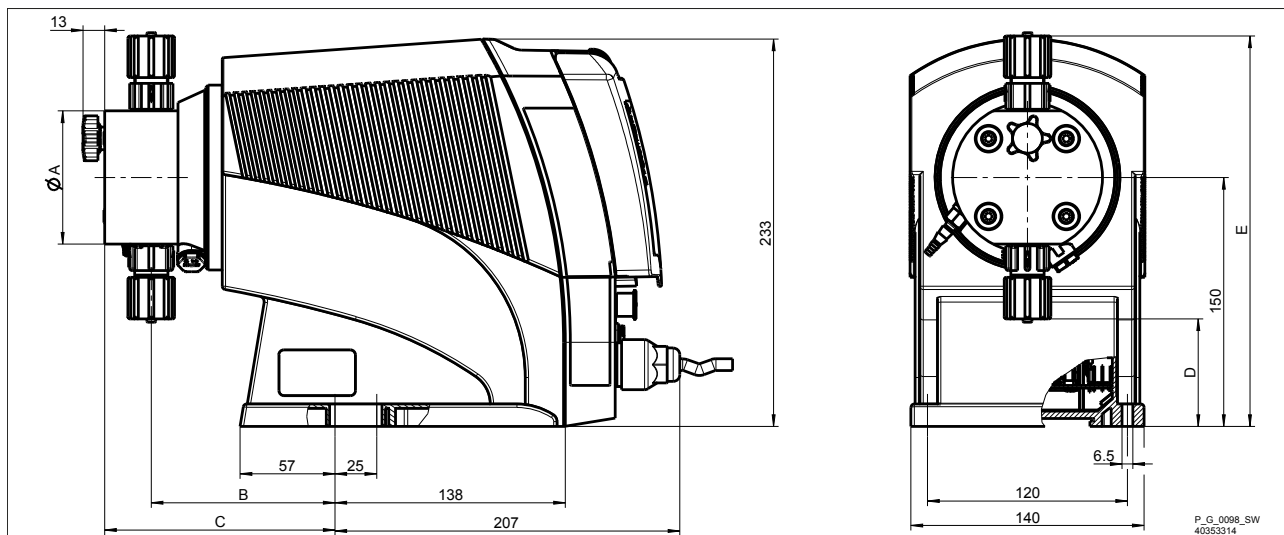

Fig. 55

	2508	1608	1612	1020	0730
ØA	90	90	90	90	90
B	110	110	110	112	112
C (with bleed valve)	138	138	138	140	140
C (without bleed valve)	125	125	125	127	127
D	63	63	60	54	53
E	235	235	239	245	246

Dimensional drawing gamma/ XL,
material version PV

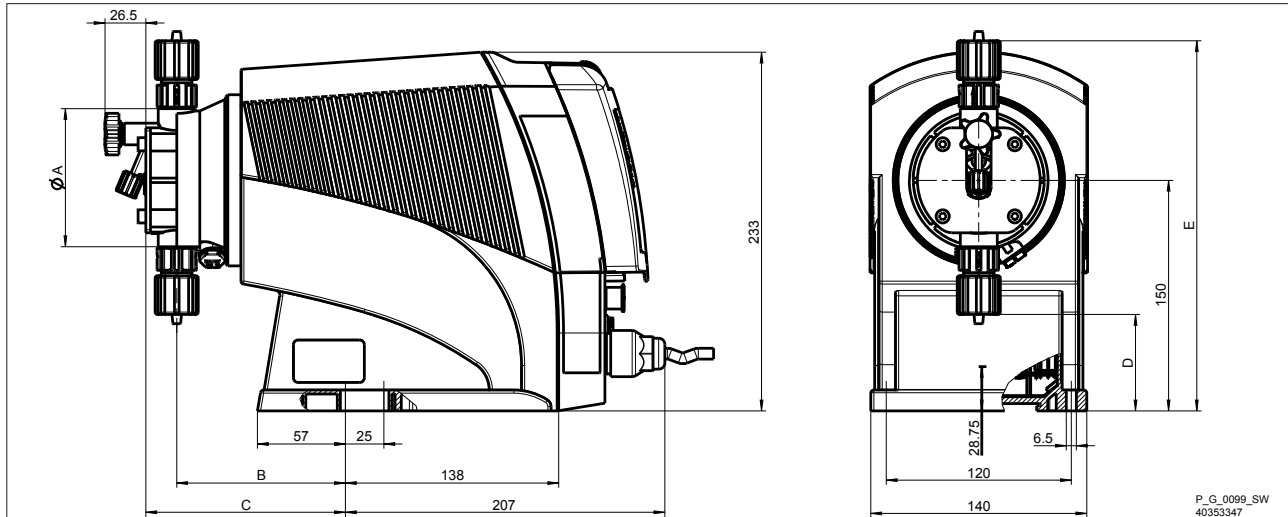

Fig. 56

	1608	1612	1020	0730
ØA	90	90	90	90
B	108	110	110	112
C (with bleed valve)	-	130	130	132
C (SER)	128	130	130	132
D	63	63	63	63
E	240	240	240	240

Dimensional drawing gamma/ XL,
material version PV DN10

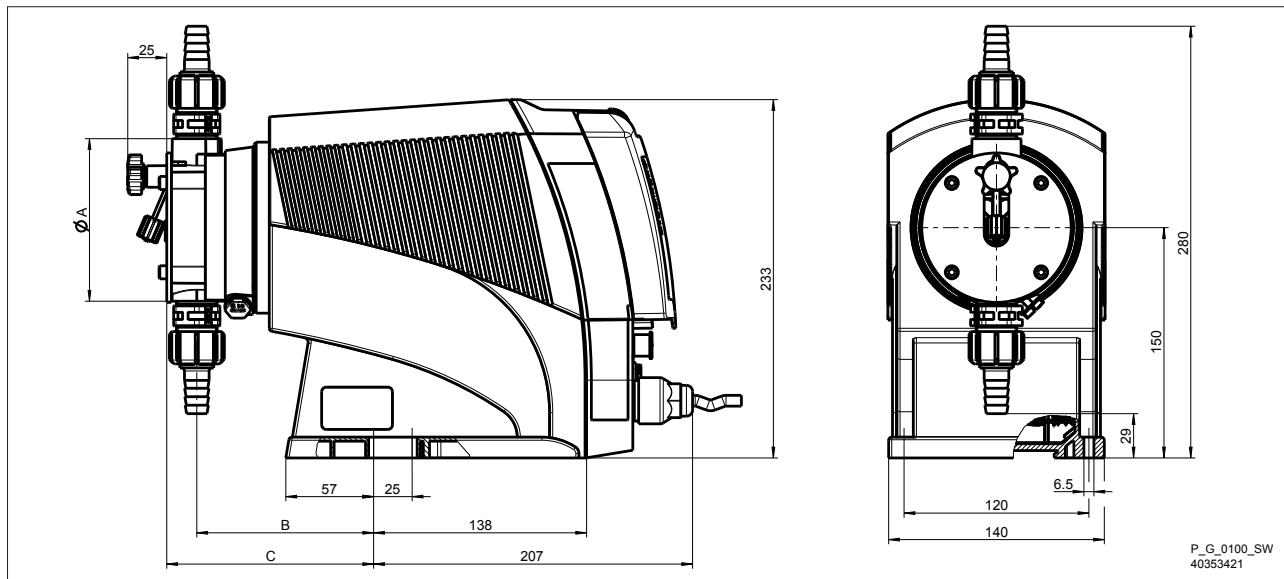

Fig. 57

	0280	0450
ØA	100	100
B	115	115
C	135	135
D	29	29
E	281	281

Dimensional drawing gamma/ XL,
material version PV HV

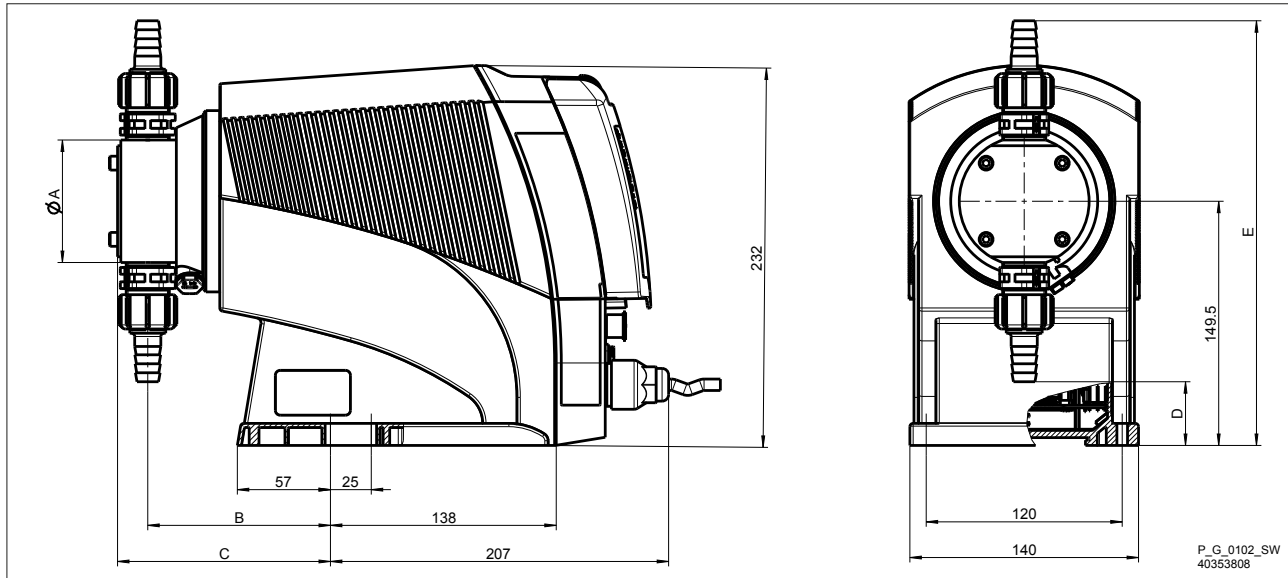

Fig. 58

	1608	1612	1020	0730
ØA	80	80	80	85
B	112	113	113	114
C	131	131	131	132
D	39	34	34	31
E	260	260	260	263

Dimensional drawing gamma/ XL
1608/ 2508, material version SS

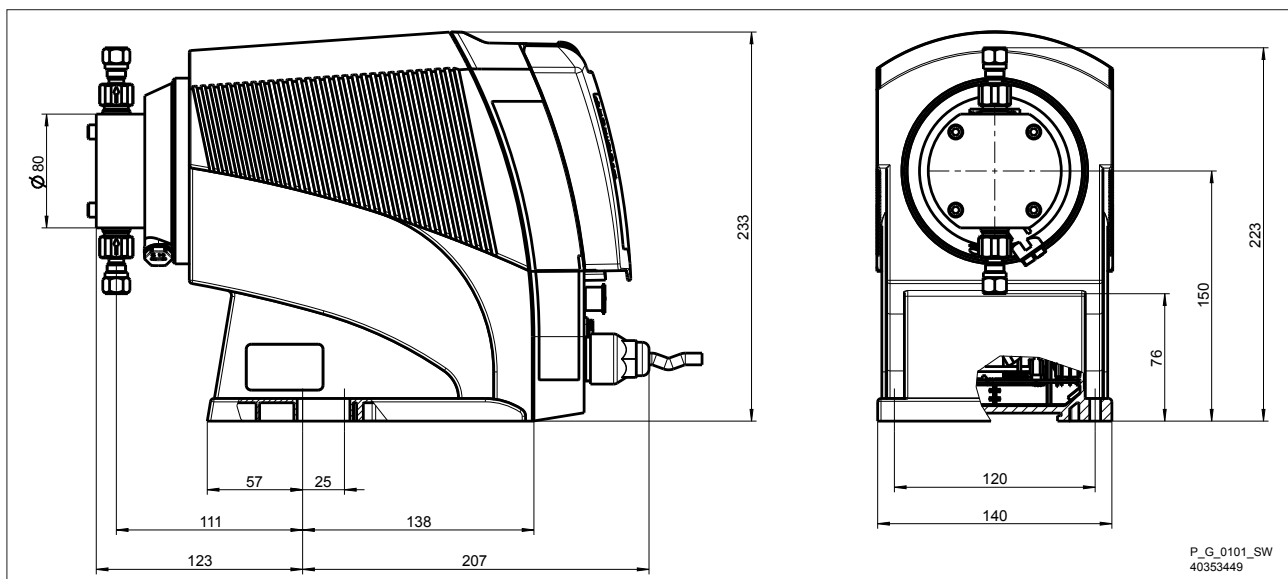
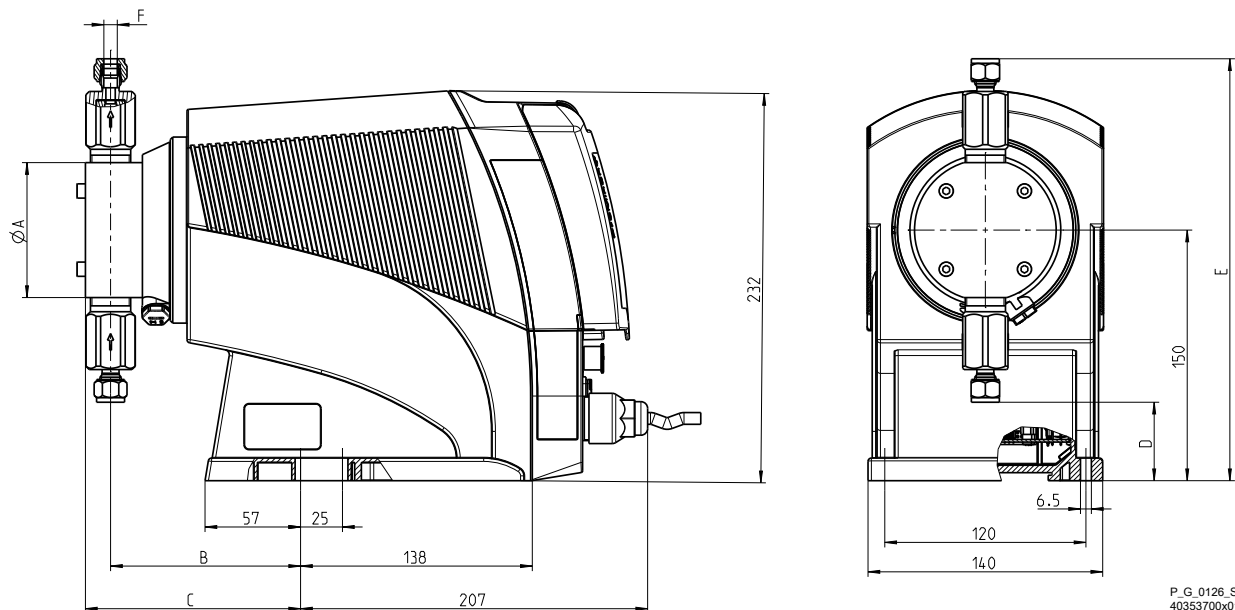

Fig. 59

Dimensional drawing gamma/ XL,
material version SS



P. G. 0126_SW
40353700x01

Fig. 60

	1612	1020	0730
ØA	85	85	85
B	113	117	117
C	128	130	130
D	47	47	47
E	252	252	252
ØF	8	12	12

Dimensional drawing gamma/ XL,
material version SS DN10

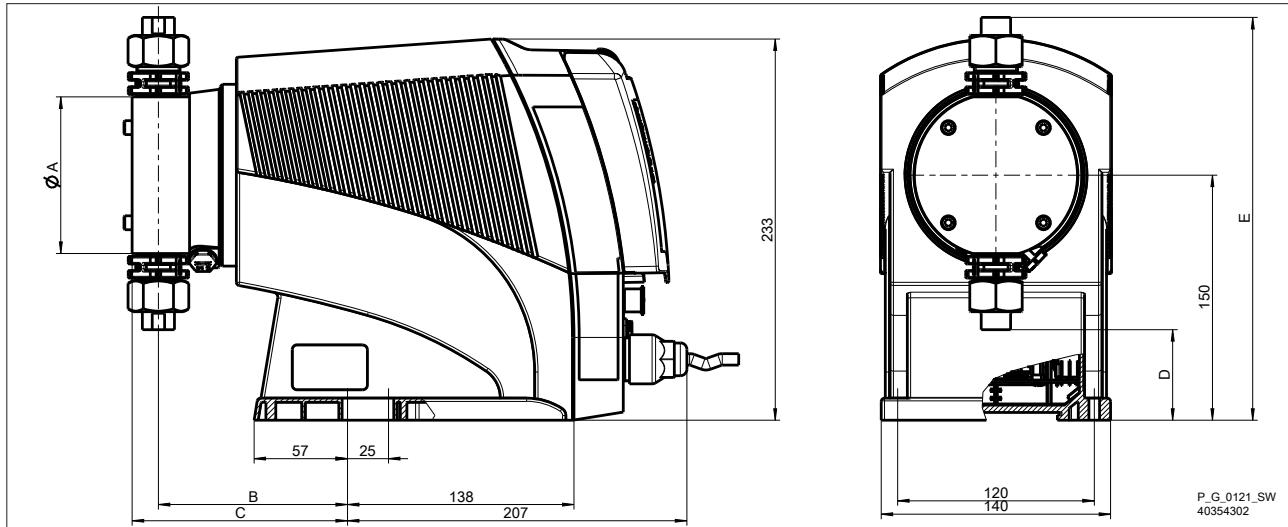

Fig. 61

	0450	0280
ØA	100	100
B	115	115
C	132	132
D	55	55
E	246	246

20 Declaration of Conformity for Machinery

In accordance with DIRECTIVE 2006/42/EC OF THE EUROPEAN PARLIAMENT AND OF THE COUNCIL, Appendix I, BASIC HEALTH AND SAFETY REQUIREMENTS, section 1.7.4.2. C.

We,

- ProMinent GmbH
- Im Schuhmachergewann 5 - 11
- D - 69123 Heidelberg, Germany,

hereby declare that the product specified below complies with the relevant basic health and safety requirements of the EC Directive on the basis of its functional concept and design and in the version marketed by us.

Any modification to the product not approved by us invalidates this declaration.

Tab. 45: Excerpt from the Declaration of Conformity

Designation of the product:	Solenoid-driven metering pump, gamma/ XL product range
Product type:	GXLa _____ U _____
Serial number:	see nameplate on the device
Relevant directives:	Machinery Directive (2006/42/EC) Compliance with the protection targets of the Low Voltage Directive according to Annex I, No. 1.5.1 of the Machinery Directive EMC Directive (2014/30/EU) RoHS Directive (2011/65/EU)
Harmonised standards applied, in particular:	EN ISO 12100: 2010 EN 809:1998 + A1:2009 / AC:2010 EN 61010-1:2010 EN 61326-1:2013 for industrial environments EN 50581:2012
Date:	03.05.2019

You can download the Declaration of Conformity at www.prominent.com.

21 UK Declaration of Conformity

We,

- ProMinent GmbH
- Im Schuhmachergewann 5 - 11
- D - 69123 Heidelberg
- Germany

herby declare that the product identified below conforms to the basic health and safety requirements of the Regulations, by virtue of its design and construction, and in the configuration placed on the market by us.

This declaration is no longer applicable if changes are made to the product without our authorisation.

Tab. 46: Extract from the Declaration of Conformity

Product description:	Dosing pump, gamma/ XL series
Product type:	GXLa _____ U ___ Y _ 0 ___ Y = 0, 3, 4, 5, C, D, E, N, R
Serial no.:	see type plate on the unit
Applicable Regulations:	Supply of Machinery (Safety) Regulations 2008 The safety objectives of the Electrical Equipment (Safety) Regulations 2016 were complied with in accordance with Appendix 1, No. 1.5.1 of the Supply of Machinery (Safety) Regulations 2008 Restriction of the Use of Certain Hazardous Substances in Electrical and Electronic Equipment Regulations 2012
Applied standards, especially:	BS EN ISO 12100: 2010 BS EN 809:1998 + A1:2009 BS EN 61010-1:2010 + A1:2019 BS EN 61000-6-2:2005 BS EN 61000-6-3:2007 + A1:2011 BS EN 61000-6-4:2007 / A1:2011 for Y = E BS EN IEC 63000:2018
Date:	01.12.2020@

You will find the UK Declaration of Conformity to download on our homepage.

22 Operating / set-up overview gamma/ XL

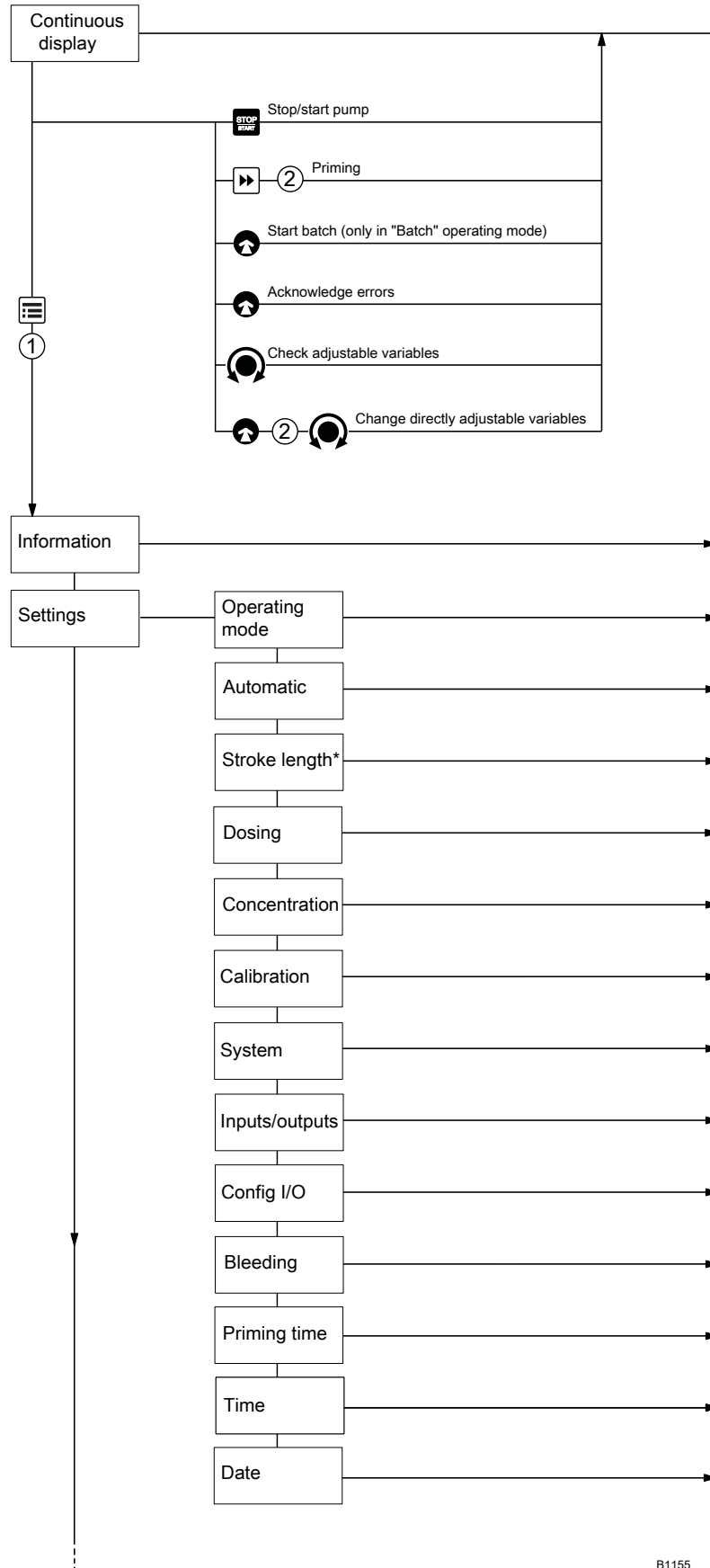

B1155

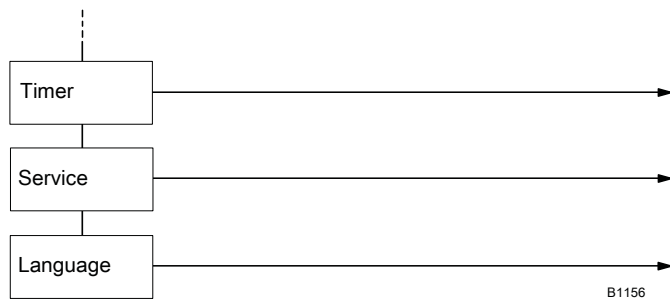

23 gamma/ XL operating menu, overall

1. level	2.	3.	4.	5.	xth
Information	Versions	Control	Hardware Software Bootloader		
		Power	Hardware Software Bootloader		
		HMI data			
	Time				
	Date				
	Max. capacity *1 Max. capacity *2				
	Serial number				
	Identity code				
	Switch-on counter				
	Total operating time				
	Total number of strokes				
	Total metering volume *1				
	Current stroke volume				
Settings	Operating mode	Manual			
		Contact	<i>Adaptive</i> On Off	<i>Memory</i> On Off	...
					...
		Batch	<i>Memory</i> On Off	Metering volume *1	Metering time *1
				Factor *2	...
		Analogue	0...20 mA 4...20 mA		
			Linear curve Lower side band Upper side band	Curve point 1 (I1,F1)	...
	Automatic	On Off			

1. level	2.	3.	4.	5.	xth
	Stroke length *2	1 ... 100%			
	Dosing	Discharge stroke	optimum fast sine mode continuous DFMa		
		Suction stroke	normal HV1 HV2 HV3		
		Pressure stage	x bar		
		Monitoring	Air lock	Inactive Warning Fault	
			Air sensitivity	normal average weak	
			Message with overpressure	Warning Fault Error+warning Inactive	
			Message when no pressure	Inactive Warning Fault Error+warning	
			Cavitation	Inactive Warning	
		Compensation*1 *2	Inactive Active		
		Adaptive control	Inactive Adaptive Save param. Restore old values		
	Concentration	Concentration control active inactive	at <i>'Manual'</i> : Flow of main medium	Concentration of feed chemical	...
			at <i>'Contact'</i> : Contact interval	Concentration of feed chemical	...

1. level	2.	3.	4.	5.	xth
			at 'Batch': Volume main medium	Concentration of feed chemical	...
			for 'Analogue': Max. flow of main medium	Concentration of feed chemical	...
	Calibration	Calibration factor	Calibration factor		
		Calibration	Start calibration	Calibration ended	Calibra- tion result
	System	Dosing head	Self-bleeding: No	No dosing head ... 0280	
			Groove	No dosing head ... 0280 SER	
			Steel	No dosing head ... 0280 SS	
		Volume unit	Litres Gallon (U.S)		
		Pressure unit	bar psi		
		Pressure adjust- ment	<i>Password?</i>	... bar	
		Start behaviour	always STOP always on last status		
	Inputs/outputs	Auxiliary mode	Auxiliary capacity *1 Auxiliary fre- quency *2 Auxiliary stroke length *2	...	

1. level	2.	3.	4.	5.	xth
		Relay 1	Relay1 type	Timer Fault Warning Warning + error Warning, error + stop Pump active Cycle quantity Stroke rate Metering / Batch Bleeding	
			Relay 1 polarity	energizing (N/O) releasing (N/C)	
			Relay cycle quantity	01.000 l	
		Relay 2	Relay type	Inactive Fault Warning Warning + error Warning, error + manual stop Pump active Metering volume Stroke rate Metering / Batch Bleeding External	
			Polarity	energizing (N/O) releasing (N/C)	
		mA output	0...20 mA 4...20 mA	Strokes / hour Litre / hour at 20 mA	...
		Flow control	Flow Control	Tolerance / strokes	...
				Activation	...
				if auxiliary	...
		diaphragm rupture	Warning Fault		
		Pause input	N/C N/O		
		Level monitor	2-stage	N/C N/O	

1. level	2.	3.	4.	5.	xth
			continuous	Calibration Configure	
	Config I/Os	Set Config I/Os	Config I/O 1 Config I/O 2 Config I/O 3	off Timer input Timer output AUX Selective fault Selective warning Stroke rate Cycle quantity Metering / Batch Fault Warning Warning + error Warning, error + stop Pump active	...
		Config I/O 1 xxxxxx Config I/O 2 xxxxxx Config I/O 3 xxxxxx			
	Bleeding	Off			
		Periodic	Bleed cycle	Bleed metering time	...
		Air lock	Bleed metering time		
		both	Bleed cycle	Bleed metering time	...
	Priming time	0 ... 60 s			
	Set time	Time	Setting	hh.mm.ss	
		Auto. summer time	Yes No		
		Summer time begins in	February March April		
		Sunday the	1st, 2nd, 3rd, 4th, 5th		
		Summer time ends in	August September October November		

1. level	2.	3.	4.	5.	xth
		Sunday the	1st, 2nd, 3rd, 4th, 5th		
		Location	Northern Hemisphere Southern Hemisphere		
	Date	dd.mm.yyyy			
Timer	Timer status				
	Activation	Active Inactive			
	Setting the timer	New Displays Change Clear	Command 01 Anweisung2 ...	Hourly Daily (Mon-Sun) Weekdays1 (Mo-Fr) Weekdays2 (Mo-Sa) Weekend (Sa+Su) Weekly Monthly Init Delayer Config I/O 1 Config I/O 2 Config I/O 3	...
	Clear all	No Yes			
Service	Access protection	<i>Password?</i>	None Locking menu Lock all		
	Password	<i>Password?</i>	0000		
	Clear counter	Stroke counter Quantity counter Contact memory All			
	Error log book	Error log book	...		
		Filter	None Warn.+error only Error only Warnings only Events only		

1. level	2.	3.	4.	5.	xth
	Diaphragm replacement	Back To change position			
	Display	Brightness			
		Contrast			
	Factory setting	<i>Password?</i>	Yes No		
	Diaphragm part number: -----				
	Spare parts kit part number: -----				
Language	English German Frenchç Spanishñ Italian ...				

*1 with 'Automatic' - 'on' - see Chap. 'Set Up' - 'Settings' - 'Automatic'

*2 with 'Automatic' - 'off' / with conventional operating mode

Menus may be missing or added depending on the design and equipment on the pump.

24 Continuous displays and secondary displays

Continuous displays

Continuous display	"Manual" operating mode	"Contact" operating mode with transfer factor 5	"Batch" operating mode with transfer factor 5	"Analogue" operating mode
Capacity	12.00 _h **	12000 _h *	12,000 _h *	12.00 _h **
Stroke rate (h)	12,000 _h *	12000 _h *	12,000 _h *	12,000 _h *
Stroke rate (min)	200 _{h/min} *	200 _{h/min} *	200 _{h/min} *	200 _{h/min} *
Stroke length	50.0 _% *	50.0 _% *	50.0 _% *	50.0 _% *
Factor		5 _{h/~/} *	5 _{h/~/} *	
Contact volume		1,250 _{l/~/} **	1,250 _{l/~/} **	
Batch dosing time			90 _s **	
Concentration	03.5 _% **	03.5 _% **	03.5 _% **	03.5 _% **
Trigger batch			 PUSH	
Time	16:12:21	16:12:21	16:12:21	16:12:21

* only with "Automatic" off

* only with "Automatic" on

Auxiliary displays in the continuous display

Auxiliary display	Mode "Manual"	Mode "Batch" with transfer factor 5	Mode "Contact" with transfer factor 5	Mode "Analogue"
Capacity	12.00 L/h			12.00 L/h
Stroke rate	12000 CP/h	12000 CP/h	12000 CP/h	12000 CP/h
Factor		5 CP/...	5 CP/...	
Remaining strokes			25,00 ↓ CP ¹	
Remaining litres			000,833 ↓ L ¹	
Total number of strokes	86500 CP	86500 CP	86500 CP	86500 CP
Stroke length	50 %	50 %	50 %	50 %
Signal current (at the input)				12,7 mA ²
Dosing mode	slow HV1	slow HV1	slow HV1	slow HV1
Pressure display	12.5 bar	12.5 bar	12.5 bar	12.5 bar
Time	16:12:21	16:12:21	16:12:21	16:12:21
Date	2015 - 03 - 27	2015 - 03 - 27	2015 - 03 - 27	2015 - 03 - 27

1 = only with "Storage tank" function extension

2 = only with current output

25 Installation instructions: Retrofitting, relays

Tab. 47: These installation instructions apply to:

Designation	Order no.
Fault indicating relay	1050643
Fault indicating and pacing relay	1050654
Fault indicating relay + 4-20 mA output	1050655

Materials

Torx spanner T 25.

A pocket torch can help to find the 4x2 contact in the slot for the relays more easily.

Requirement:

Personnel: ■ Electrician

Scope of delivery

- 1 - Relay board, fully assembled.
- 1 - Relay cable, fully assembled, with connector.
- 1 - Seal.

Live parts can be accessed if the slot for the relay has been opened.

- Disconnect the pump from the mains power supply before working on it.
- Only operate the pump with a liquid-tight screwed slot for the relay and connector for the relay cable.

1. ➤ Disconnect the pump electrically.
2. ➤ Remove the cover of the slot.
3. ➤ Hold the relay board by the edge of the relay cover.
4. ➤ Carefully insert the relay board into the slot for the relay - the opening in the board in the slot will help with this (A). At the same time make sure that the 3x2 pins on the relay board are sitting correctly and on the left contacts of the 4x2 contact in the slot (B) - see Figure.
5. ➤ Push the relay board into the slot with gentle pressure.
6. ➤ Use the screws to screw the relay cover to the housing until liquid-tight.
7. ➤ Insert the seal connector of the relay cable into the relay cover.
8. ➤ Push the connector onto the pins of the relay cover and then tighten the screw into the connector until liquid-tight.

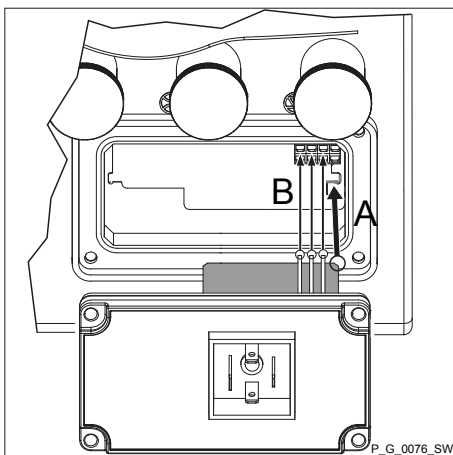

Fig. 62: Slot (B)

26 Index

1, 2, 3 ...	86	Bleeding	42, 76
"External control" terminal	38	Selective errors	76
0...20 mA	73	Bluetooth Name	49
2-stage	74	Brightness	95
4 - 20 mA	53	BT device address	49
4...20 mA	73		
A		C	
About This Pump	9	Calibrate	26, 67
Access code	94	Calibrate, level measurement	75
Access protection	48, 93	CAN bus	37
Accuracy	116	Capacity at 20 mA	73
Acknowledge	97	Capacity too low	
Adaptive	50	Selective warning	76
Adjustment	69	Cavitation	57
Air in dosing head		Check adjustable variables	97
Selective errors	76	Checking adjustable variables	48
Selective warning	76	Cleaning the diaphragm rupture sensor	104
Air lock	59	Cleaning valves	104
Altitude of site	119	Clear	94
Analog	25	Clear counters	94
Analog input iMax		Clickwheel	18
Selective errors	76	Code	94
Analog input iMin		Compensation	60
Selective errors	76	Concentration	60
Analogue	40	Concentration entry	60
Analogue input	39, 53	Config I/O	37
Applicable Regulations	142	Config-I/Os	76
Applied standards	142	Configuration	75
Assembly	29	Connector size	116
Automatic	55	Contact	25, 50
Automatic degassing	27	Contact - adaptive	50
AUX	71	Contact memory	94
Auxiliary	76	Contact water meter	52
Auxiliary capacity	39, 40, 71	continuous	75
Auxiliary dosing rate	26, 27	Continuous display	19
Auxiliary frequency	26, 27, 39, 40, 71	Continuous displays	48, 152
		continuous level measurement	41
B		Contrast	95
Back pressure fluctuations	60	Control elements	18
Basic principles for setting up the control	46	Current output	44, 73
batch	71	Current stroke volume	49
Batch	25, 42, 52, 62, 64, 65	Curve	53
Behaviour, mA output	73	Cycle quantity	76

D		F	
Date	49, 78, 94, 112	Factor	50, 52
Declaration of Conformity	141, 142	Factory settings	95
Decommissioning	113	Fast	56
Decontamination declaration	16	Fault	42
Defective strokes		FAULT	106
Selective errors	76	Fault indicating and pacing relay	27
Degassing	33	Fault indicating relay	27, 43, 44
Degassing, function	26	Fault indicator	18
Degassing, mA output	73	Fault indicator (red)	27
Degree of protection	119	Fault Level Niveau	75
Demonstration purposes	69	Fault message	19
Detailed view	94, 112	Fault messages	106
DFMa	56	Fault statuses	27
Diaphragm	95	Faults without a fault message	105
Diaphragm part number	95	Fill	56
Diaphragm replacement	95, 102	Flow control	73
Diaphragm replacement position	95	Flow Control	73
Diaphragm rupture	74	Flow monitor	26
Selective errors	76	Functional description	23
Selective warning	76	Functions	26, 27
Diaphragm rupture indicator	41		
Dielectric constant	75	G	
Dimensional drawings	135	Gas lock	59
Directly adjustable variables	97	General non-discriminatory approach	2
Discharge stroke	23, 56		
Display	95	H	
Disposal	114	Hardware	49
Dosing	42	Hemisphere	78
Dosing precision	60	Hierarchy of operating modes	27
Draining the liquid end	113	HMI	37
DulcoFlow	56	HMI operating unit	37
DulcoFlow®	73	HMI version	49
		HV1	57
E			
Electrical installation	35	I	
Emergency	14	Identification of safety notes	10
Error	27, 71, 76, 109	Identifier	19
Error log book	94	Identity code	6
Error processing	54	Identity Code	49
Error, mA output	73	Information	49
EU Declaration of Conformity	141	Information in the event of an emergency	14
Events	111	Input signal mA	
External contact	27, 39, 40	Selective errors	76
External frequency changer	27	Inputs/outputs	70
		Installation, electrical	35

- Installation, hydraulic 30
- Installing hose lines 31
- Invalid metering vol.
 Selective warning 76
- IP 119
- K**
- Keys 18, 21
- L**
- Language 96
- LCD screen 18, 95
- Leakage hole 99
- Level 74
 Selective errors 76
 Selective warning 76
- Level error 74
- Level measurement, continuous 41
- Level switch 26, 40, 43
- Level warning 74
- Linear curve 53
- Liquid level percent 75
- Location 78
- Lock 93
- Log book 94, 109, 110, 111
- Log book entries 94
- Log book entry 94, 112
- Lost in hyperspace 46
- Low pressure
 Selective warning 76
- Lower side band 54
- M**
- mA input 39, 53
- mA output 27, 73
- Main display 19
- Mains cable 36
- Maintenance 99
- Manual 25, 27, 50, 61
- Maximum capacity 49
- Maximum metering rate 49
- Memory 50, 52
- Memory overflow
 Selective errors 76
- Menu 49
- Metering 56, 71
- Metering monitor 41, 73
 Selective warning 76
- Metering profiles 23, 56
- Metering pumps with degassing 33
- Metering pumps without integral relief valve 33
- Metering pumps without self-degassing 31
- Metering volume / Batch 76
- Minimum Stroke Length 116
- Monitoring 59
- N**
- No pressure
 Selective errors 76
- Nominal pressure 58
- Non-discriminatory approach 2
- Normal 57
- O**
- Operating indicator (green) 18, 27
- Operating menu 145
- Operating modes 25, 27
- Operating overview 143
- Operation 97
- Optimum 56
- Optional 42
- Out-gassing 55
- Outgassing 59
- Outgassing feed chemicals 57
- Overload
 Selective warning 76
- Overpressure
 Selective errors 76
- Overview of equipment 17
- P**
- Pacing relay 44
- Password 48, 94
- Pause 26, 27, 39, 74
- Perc. liquid level 75
- Performance data 116
- Polarity 71
- Pressure 58
- Pressure adjustment 69
- Pressure display 19
- Pressure rating 58
- Pressure unit 69

Priming	27, 97	Set-up overview	143
Priming time	77	Setting	46
Product type	142	Setting mode	48
Protection against contact and moisture	119	Settings	49
Protection menu	93	Side band	53, 54, 55
Pulse control	52	Slot	18
Pulses	50	Slow	56
Pump active	42, 71, 76	Software	49
Q		Sound pressure level	14, 119
Qualification of personnel	14	Spare parts kit	95
R		Spare parts kit part number	95
Relay	42, 71	Standard installation	34
Relay polarity	43, 72	Standard signal output	73
Relay type	71	Start a batch	97
Relays	26	Start behaviour	70
Repair	101	Stop	26, 27, 76
Replacement position	102	Stop, mA output	73
Replacing the diaphragm	102	Storage	16
Replacing the dosing head	69	Storage period	91
Reproducibility	116	Stroke counter	94
Return line	33	Stroke length	55
Return pipe	31, 33	Stroke length, manual	55
S		Stroke rate	42, 71, 76
Safety declaration form	16	Stroke rate since switching on	94, 112
Safety requirements	119	Suction lance	26
Scaling, mA output	73	Suction lance electrodes	75
Scope of Delivery	16	Suction lance, continuous	75
Secondary display	19	Suction stroke	23, 24, 55, 57
Secondary displays	48, 153	Summertime	78
SEK dosing head	69	Sunday	78
Select the analogue signal	73	Supplementary information	2
Selecting the operating mode	50	Supply voltage	36
Selective errors	76	Switch-off pressure	59
Selective warning	76	Switch-on counter	49
Self-degassing	25	Switching-on duration	94, 112
Semiconductor switch	44	Symbols	34
Sensitivity air detect	59	System	68
SER types	25	T	
Serial no.	142	Technical data	116
Serial number	49	Temperature	94, 112
Service	93	Selective errors	76
Set time	78	Terminals	18
Set up, chapter	49	Test (function)	27
		Time	49, 94, 112

Timer	78	Sorting sequence	86
1 time event - several actions	85	Switching time	83
Action	81	Terminal	37
Actions	92	Time	83
Activation	79	Time event	81
active	79	Timer information	91
active / inactive	91	Trigger	81, 92
Administration functions for commands	80	Triggering event	92
Change program lines	87	Timer terminal	37
Check program lines ("Show")	86	Timer, function	26
Clear all	87	Total metering volume	49
Clear individual program lines	87	Total number of strokes	49, 94, 112
Clear program lines	87	Total operating time	49, 94, 112
Clear, all	87	Transport	16
Clearing the program	87	Troubleshooting	105
Config I/O	37		
Creating a program	79	U	
Cycle	83	Unit Level	75
Deactivation	79	Unpacking	16
Delayer	84, 93	Upper side band	55
Event	81		
Examples	87	V	
Explanation of functions	92	Versions	49
Explanation of selected functions	92	Viscosity	55, 57
Functional faults	91	Volume counter	94
Generating commands	79	Volume unit	69
inactive	79		
Init	83	W	
Initialisation	92	Warning	42, 71, 76, 110
input	76	WARNING	108
Inputs	85, 93	Warning indicator	18
Metering	88	Warning indicator (amber)	27
new program line	80	Warning Level Niveau	75
Output	76	Warning message	19, 43
Outputs	85, 92	Warning messages	108
Pitfalls	91	Warning sign	10
Power supply	91	Warning, mA output	73
Program line	79	Warnings	110
Program line new	80		
Sequence	86		
set	79		
several actions - 1 time event	85		
Show instruction	86		
Show program line	86		
Sorting criterion	86		



ProMinent GmbH
Im Schuhmachergewann 5 - 11
69123 Heidelberg
Germany
Telephone: +49 6221 842-0
Fax: +49 6221 842-419
Email: info@prominent.com
Internet: www.prominent.com

982271, 3, en_GB