

# Operating Instructions

## DULCOMETER® D1C

Part 2: Adjustment and Operation,  
Measured variable peracetic acid (PAA) for PAA 1 probe



D1C2-PES-001-GB



Type D



Type W

D1C A

Please enter the identity code of your device here.

**Please completely read through operating instructions! · Do not discard!**  
**The operator shall be liable for any damage caused**  
**by installation or operating errors!**

# 1 Device Identification / Identity Code

D1C A	<b>DULCOMETER® Controller Series D1C / Version A</b>	
	<b>Type of mounting</b>	
D	Control panel installation 96 x 96 mm	
W	Wall mounting	
	<b>Operating voltage</b>	
0	230 V 50/60 Hz	
1	115 V 50/60 Hz	
2	200 V 50/60 Hz (only with control panel installation)	
3	100 V 50/60 Hz (only with control panel installation)	
4	24 V AC/DC	
	<b>Measured variable</b>	
A	Peracetic Acide	
	<b>Connection of measured variable</b>	
7	Terminal, standard signal 0/4-20 mA for PAA 1-mA-200 ppm, PAA 1-mA-2000 ppm	
	<b>Correction variable</b>	
4	manual temperature input	
	<b>Feed forward control</b>	
0	None	
1	via standard signal 0/4-20 mA	
2	via frequency 0-500 Hz	
3	via frequency 0-10 Hz	
	<b>Control input</b>	
0	None	
1	Pause	
	<b>Signal output</b>	
0	None	
1	standard signal 0/4-20 mA measured value	
2	standard signal 0/4-20 mA control variable	
3	standard signal 0/4-20 mA correction variable	
4	2 standard signal 0/4-20 mA outputs, free programmable	
	<b>Power control</b>	
G	Alarm and 2 limit value/timer relays	
M	Alarm and 2 solenoid valve relays	
R	Alarm relay and servomotor with feedback	
	<b>Pump control</b>	
0	None	
2	Two pumps	
	<b>Control characteristic</b>	
0	None	
1	Proportional control	
2	PID control	
	<b>Log output</b>	
0	None	
	<b>Language</b>	
D	German	
E	English	
F	French	
I	Italian	
N	Dutch	
S	Spanish	
B	Portuguese	
G	Czech	
J	Japanese	

D1C A \_ \_ \_ \_ \_

Please enter the identity code of your device here!

---

## 2 General User Information

---

	Page
1 Device Identification / Identity Code .....	2
2 General User Information .....	3
3 Device Overview / Controls .....	4
4 Functional Description .....	5
5 Display Symbols .....	6
6 Operation .....	7
7 Restricted Operating Menu .....	8
Overview .....	8
Description .....	9
8 Complete Operating Menu .....	12
Overview .....	12
Description .....	13
9 Faults / Remarks / Troubleshooting .....	25

### General User Information

These operating instructions describe the technical data and function of the series DULCOMETER® D1C controller, provide detailed safety information and are divided into clear steps.



#### **IMPORTANT**

- ***Please observe the parts of these operating instructions applicable to your particular version! This is indicated in the Section “Device Identification / Identity Code”!***
- ***Correct measuring and dosing is only possible in the case of impeccable operation of the probe. The probe has to be calibrated / checked regularly!***

#### **NOTE**

***A form “Documentation of controller settings Type D1C” is available under [www.prominent.com/documentation\\_D1C](http://www.prominent.com/documentation_D1C) for the purpose of documenting the controller settings.***

### 3 Device Overview / Controls

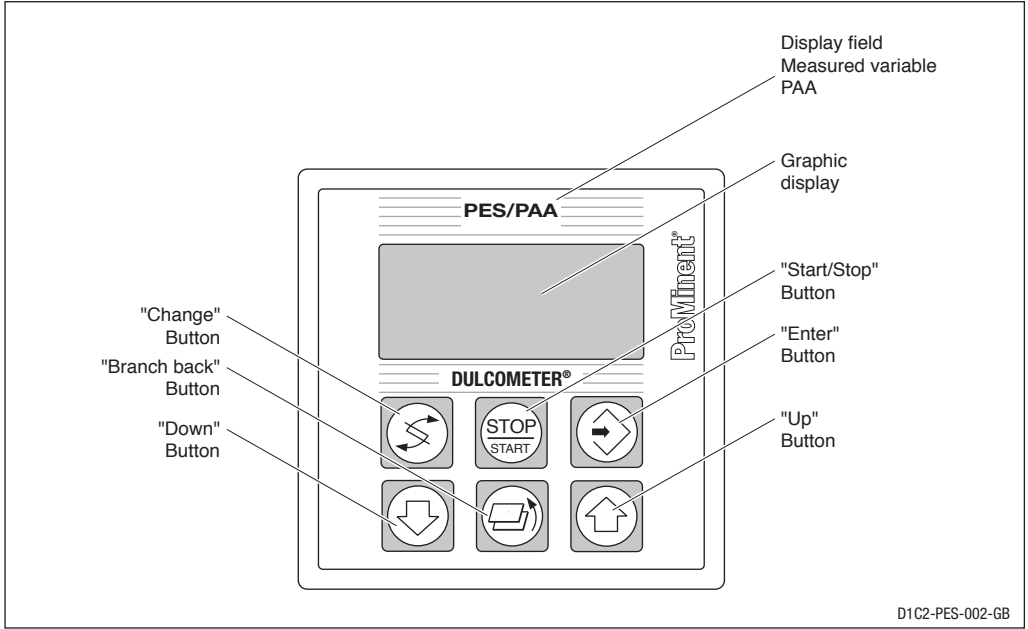

D1C2-PES-002-GB

	<p><b>CHANGE Button</b></p> <p>To change over within a menu level and to change from one variable to another within a menu point.</p>
	<p><b>START/STOP Button</b></p> <p>Start/stop of control and metering function.</p>
	<p><b>ENTER Button</b></p> <p>To accept, confirm or save a displayed value or status. For alarm acknowledgement.</p>

	<p><b>UP Button</b></p> <p>To increase a displayed numerical value and to change variables (flashing display).</p>
	<p><b>BRANCH BACK Button</b></p> <p>Back to permanent display or to start of relevant setting menu.</p>
	<p><b>DOWN Button</b></p> <p>To decrease a displayed numerical value and to change variables (flashing display).</p>

---

## 4 Functional Description

---

### NOTE

*Please refer to the description of the complete operating menu in Section 8 for a detailed description of the individual characteristics of the DULCOMETER® D1C controller!*

### 4.1 Operating Menu

The D1C controller permits settings to be made in two different menus. All values are preset and can be changed in the **complete operating menu**.

The controller is delivered with a **restricted operating menu** so that the D1C controller can be used effectively in many applications from the very onset. If adaptations prove to be necessary, all relevant parameters can then be accessed by switching over to the complete operating menu (see "General settings").

### 4.2 Access Code

Access to the setting menu can be prevented by setting up an access code. The D1C controller is supplied with the access code 5000 which permits free access to the setting menu. The calibration menu remains freely accessible even when access to the setting menu is blocked by the code.

### 4.3 Control

The D1C can operate as a proportional controller or as a PID controller - dependent on the device version (see identity code) and the setting.

The controlled variable is recalculated once a second. Control procedures which require rapid correction of setpoint deviations (less than approx. 30 seconds) cannot be processed with this controller. The cycle times must be taken into consideration when activating solenoid valves (pulse length) in the same way as their running times when activating servomotors (3-point).

Via the control input pause, the control function (selection of controlled variable) can be switched off. The calculation of the controlled variable starts again after cessation of "pause".

### 4.4 Feed Forward Control

The D1C controller can process a signal of a feed forward control. Depending on the device version (see identity code) and the setting, this signal can be obtained in any form of a 0–20 mA or 4–20 mA signal or as a digital contact signal with the maximum frequencies 10 Hz or 500 Hz.

This signal can be used, for example, for flow-proportional metering (multiplicative effect) or feed forward-dependent basic load metering (additive effect). The result of control variable calculation from the proportional or PID control is multiplied by or added to the feed forward signal. A multiplicative feed forward variable at the level of the set rated value carries over the calculated control variable unchanged into the controlled variable:

$$\text{Controlled variable} = \text{Feed forward variable/rated value} \times \text{calculated control variable}$$

During start-up, the zero point has to be checked. The multiplicative feed forward control is not designed for switching off permanently the actuating variable (signal  $\approx 0$ ).

An additive feed forward variable at the level of the rated value results in maximum controlled variable:























$$\text{Controlled variable (max. 100 \%)} = \text{Feed forward variable/rated value} \times \text{max. controlled variable} + \text{calculated control variable}$$

### 4.5 Error Messages

Error messages and information are indicated on the bottom line in the permanent display 1. Errors to be acknowledged (acknowledgement switches off the alarm relay) are indicated by the "E". Errors/notes which still apply after acknowledgement are indicated alternately. During correction variable processing (temperature for correction of pH-value), the value is indicated in the same line as the error/note. Faults which are rectified of their own accord due to changed operating situations are removed from the permanent display without the need for acknowledgement.

## 5 Display Symbols

The display of the DULCOMETER® D1C controller uses the following symbols:

Description	Comment	Symbol
Limit value transgression Relay 1, upper	Symbol left	
Relay 1, lower	Symbol left	
Relay 2, upper	Symbol right	
Relay 2, lower	Symbol right	
Metering pump 1 (PAA) Control off	Symbol left	
Control on	Symbol left	
Metering pump 2 (De-PAA) Control off	Symbol right	
Control on	Symbol right	
Solenoid valve 1 (PAA) Control off	Symbol left	
Control on	Symbol left	
Solenoid valve 2 (De-PAA) Control off	Symbol right	
Control on	Symbol right	
Servomotor Control, open relay		 
Control, close relay		 
Without control		 
Position feedback	Thickness of bar increases from left to right during opening.	
Stop button pressed		
Manual metering		
Fault		

## 6 Operation

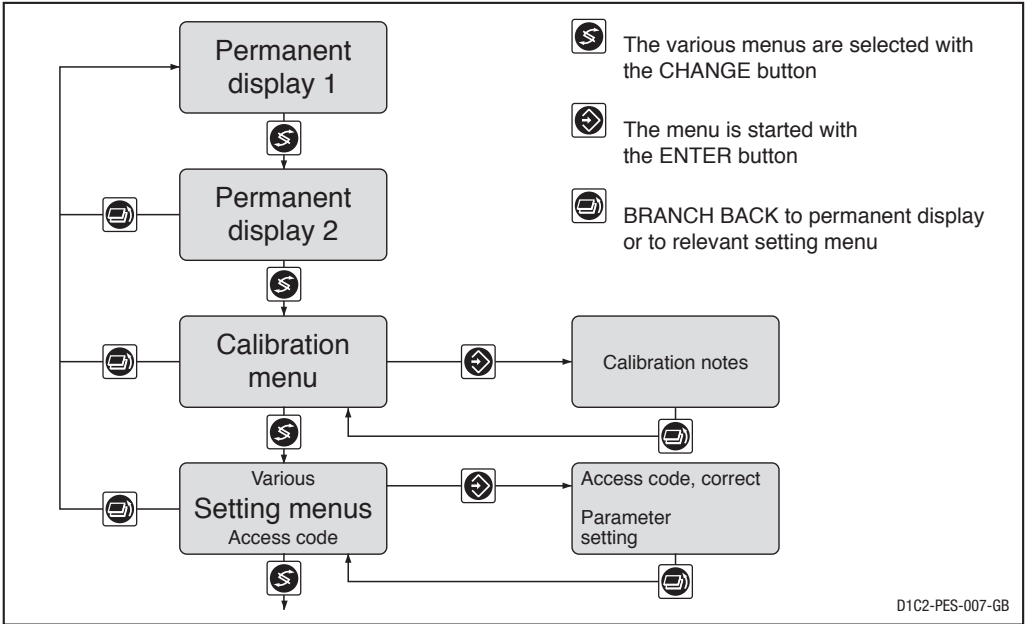

### NOTE

**Access to the setting menus can be barred with the access code!**

**The number and scope of setting menus is dependent on the device version!**

**If the access code is selected correctly in a setting menu, then the following setting menus are also accessible!**

**If within a period of 10 minutes no button is pushed, the unit automatically branches back from the calibrating menu or a setting menu to the permanent display 1.**

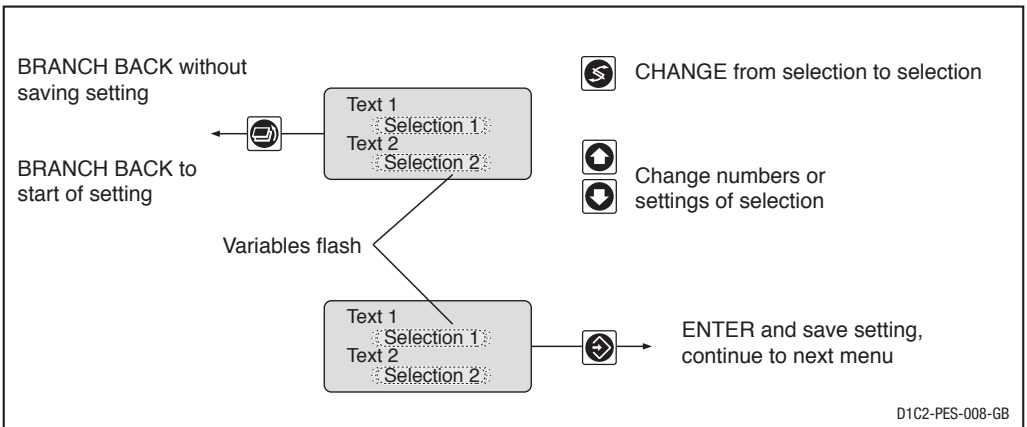

# 7 Restricted Operating Menu / Overview

The restricted operating menu permits simple operation of the most important parameters. The following overview shows the settings which can be selected:

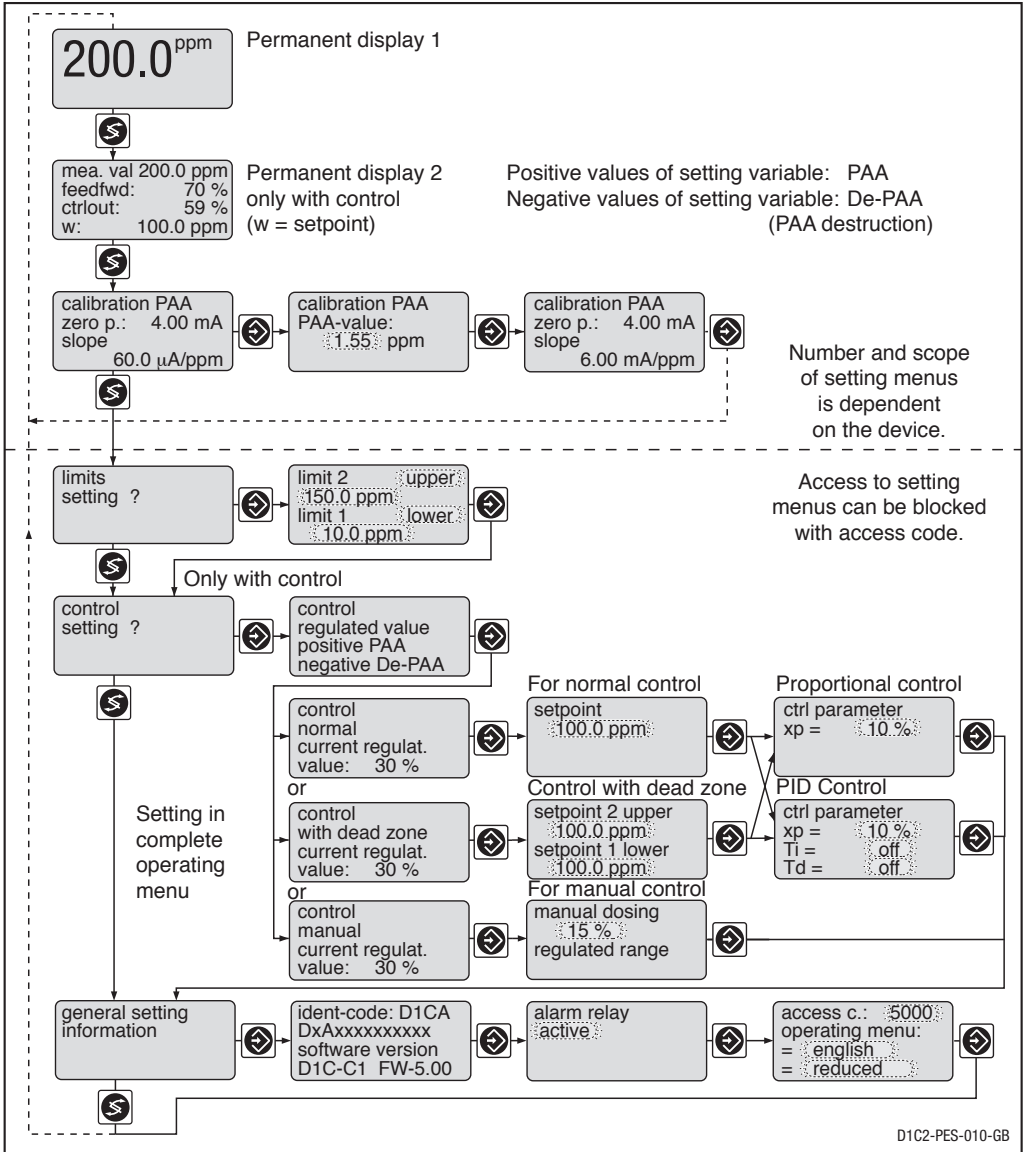

D1C2-PES-010-GB

# Restricted Operating Menu / Description

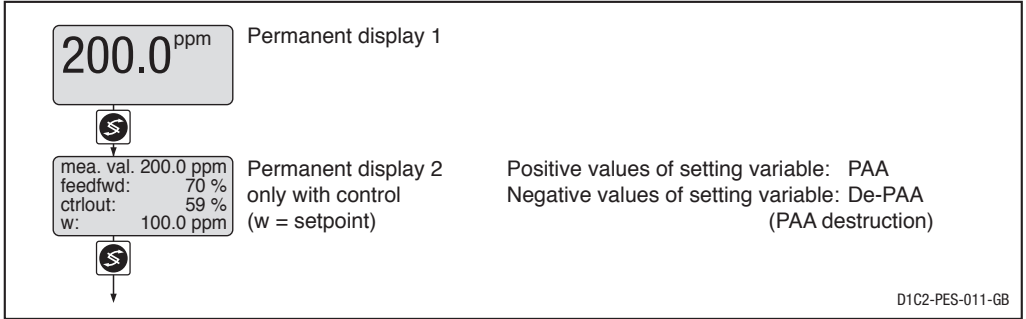

## Calibrating the PAA Probe

During calibration, the D1C sets the positioning outputs to “0”. The exception to this is that when a base load or a manual controller output has been set, these are retained during the calibration. The mA standard output signals (measured value or correcting value) are frozen. The measured value registered during the start of the calibration is proposed as the PAA value; this value is adjustable (arrow keys!). Calibration is only possible if the PAA value is  $\geq 2\%$  of the measuring range. On successful completion of calibration, all error checks which refer to the measured value are restarted.



### ATTENTION

**The measuring range of the probe must agree with the set measuring range (factory setting: 0–200.0 ppm). The measuring range must be reset prior to calibration (refer to page 14).**

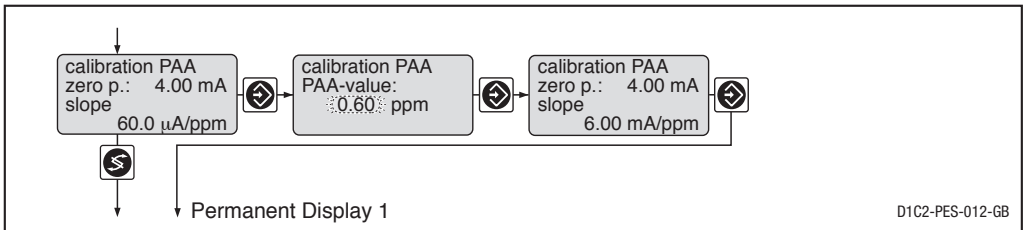

	Initial value	Possible values			Remarks
		Increment	Lower value	Upper value	
Measured value		0.1 ppm	-20 ppm	220 ppm	for measurement range up to 200 ppm
		1 ppm	-200 ppm	2200 ppm	for measurement range up to 2000 ppm

Error message	Condition	Effect
Calibration PAA not possible! Probe slope too low	PAA slope too low ( $<25\%$ of norm slope)	Calibrate again
Calibration PAA not possible! Probe slope too high	PAA slope too high ( $>300\%$ of norm slope)	Calibrate again
PAA value too low PAA > x.xx ppm	PAA $<2\%$ measuring range	

# Restricted Operating Menu / Description

## Limits

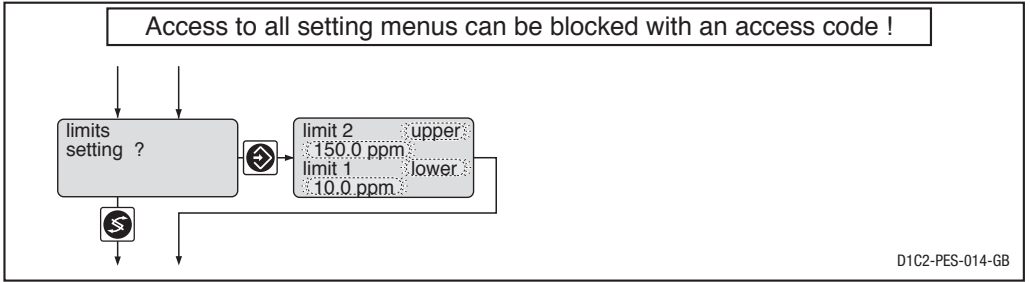

	Initial value	Possible values	Lower value	Upper value	Remarks
Type of limit transgression	Limit 1: lower Limit 2: upper	upper lower off*			Limit transgression when exceeding or dropping below value *only with limit relays
Limit value	Limit 1: 10 ppm Limit 2: 150 ppm	0.1 ppm	-20.0 ppm	220.0 ppm	
	Limit 1: 100 ppm Limit 2: 1500 ppm	1 ppm	-200 ppm	2200 ppm	

## Control

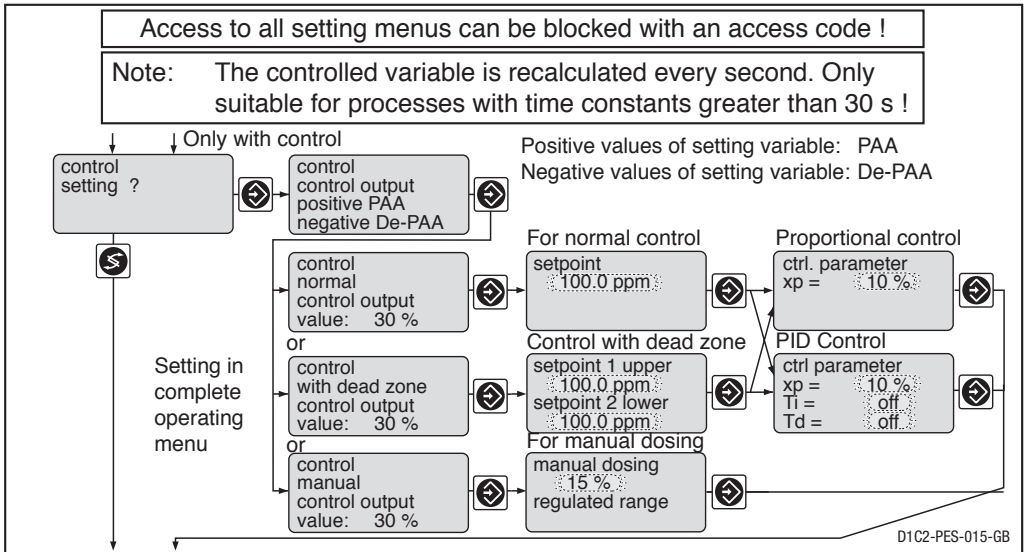

## Restricted Operating Menu / Description

	Initial value	Possible values			Remarks
		Increment	Lower value	Upper value	
Setpoint	100.0 ppm 100.0 ppm	0.1 ppm 1 ppm	-10.0 ppm -100 ppm	210.0 ppm 2100 ppm	2 setpoints necessary for control with dead zone. Setpoint 1 > setpoint 2
Control parameter xp	10 %	1 %	1 %	500 %	xp referred to measuring range
Control parameter Ti	off	1 s	1 s	9999 s	Function off = 0 s
Control parameter Td	off	1 s	1 s	2500 s	Function off = 0 s
Manual metering	0 %	1 %	-100 %	+100 %	

### Abbreviations for control variables:

$x_p$ : 100 %/Kp (inverse proportional coefficient)

$T_i$ : Integration time of I-controller [s]

$T_d$ : Differential time of D-controller [s]

### General Settings

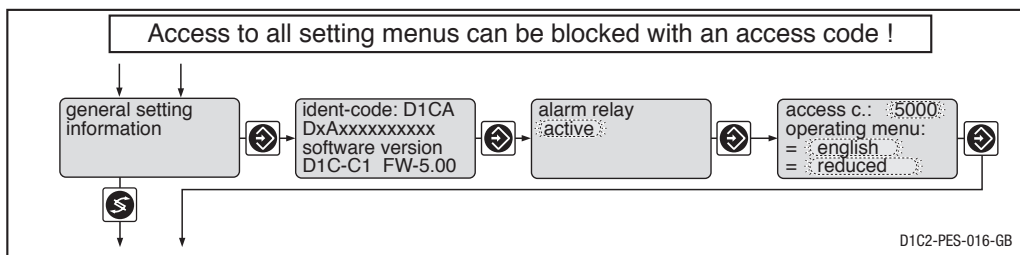

	Initial value	Possible values			Remarks
		Increment	Lower value	Upper value	
Alarm relay	active	active not active			
Access code	5000	1	1	9999	
Language	as per identity code	as per identity code			
Operating menu	restricted	restricted complete			

### Access Code

Access to the setting menu can be prevented by setting up an access code. The DULCOMETER® D1C controller is supplied with the access code 5000 which permits free access to the setting menu. The calibration menu remains freely accessible even when access to the setting menu is blocked by the code.

# 8 Complete Operating Menu / Overview

All parameters of the controller can be set in the complete operating menu (access see previous page). The following overview shows the settings which can be selected:

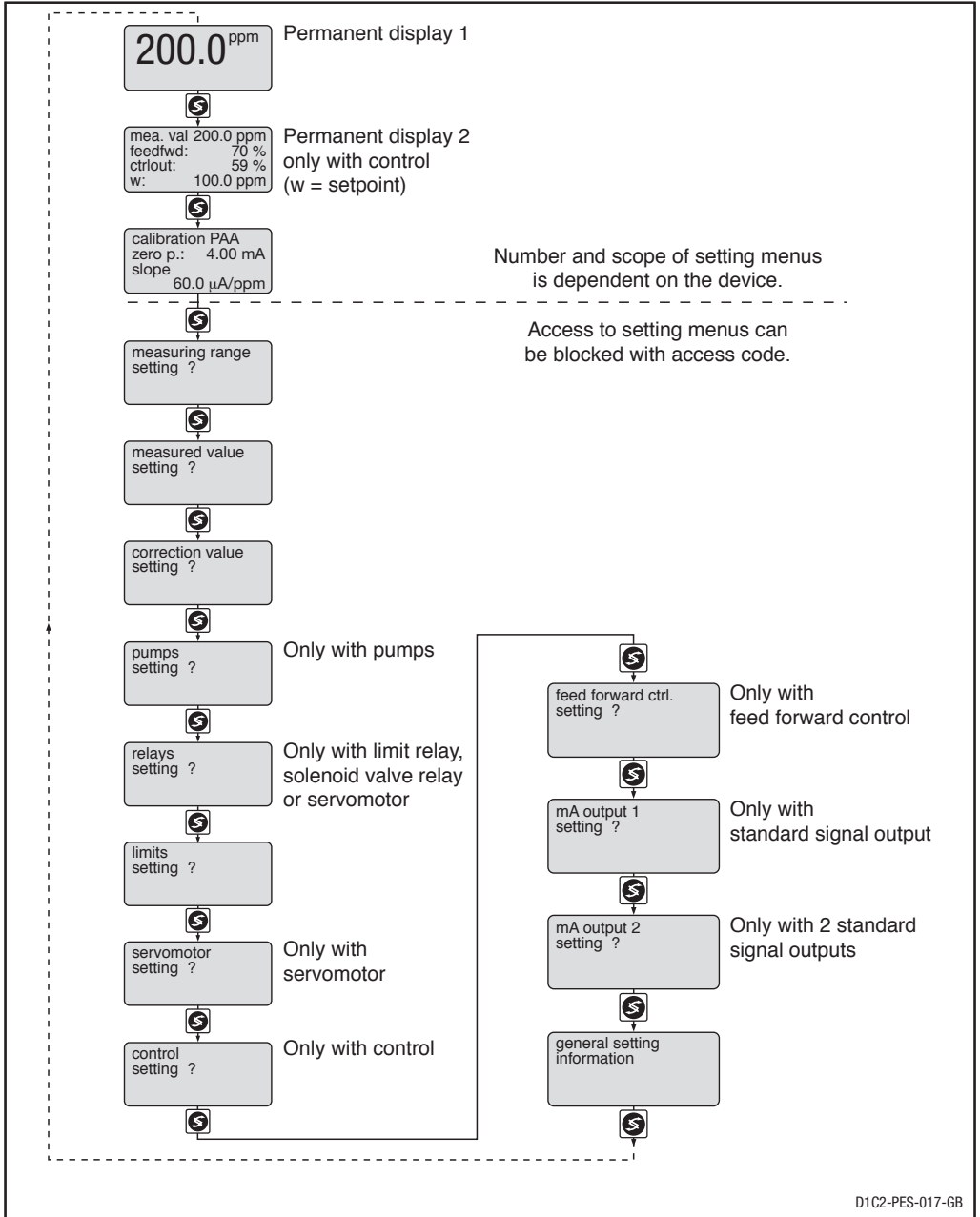

# Complete Operating Menu / Description

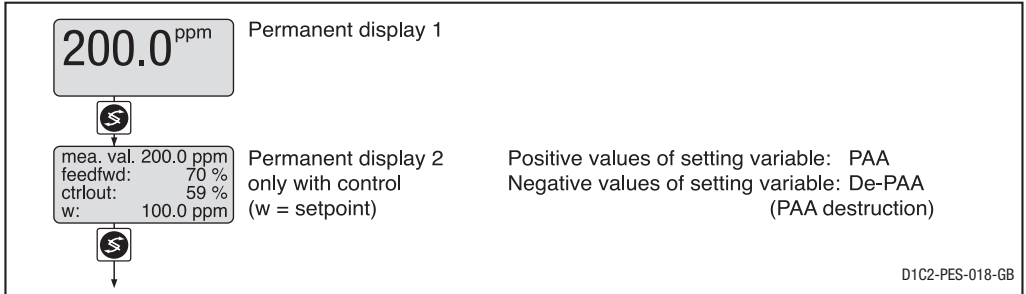

## Calibrating the PAA Probe (zero point and slope)

During calibration, the D1C sets the positioning outputs to “0”. The exception to this is that when a base load or a manual controller output has been set, these are retained during the calibration. The mA standard output signals (measured value or correcting value) are frozen. The measured value frozen at the start of calibration is offered as the PAA value; this value is adjustable (arrow keys!). Calibration is only possible when the PAA value is  $\geq 2\%$  of the measurement range. Once calibration has been successfully completed, all fault tracing procedures which refer to the measured value are restarted.

Zero point calibration must be carried out under real conditions in water free of PAA. Calibration is normally only necessary when measuring at the lower limit of the measuring range.



### ATTENTION

**The measuring range of the probe must agree with the set measuring range (factory setting: 0–200.0 ppm). The measuring range must be reset prior to calibration (refer to page 14).**

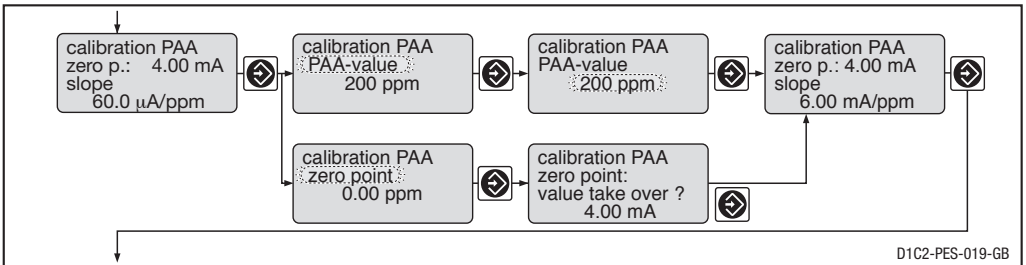

	Initial value	Possible values			Remarks
		Increment	Lower value	Upper value	
Measured value		0.1 ppm 1 ppm	-20 ppm -200 ppm	220 ppm 2200 ppm	for meas. range up to 200 ppm for meas. range up to 2000 ppm

Error message	Condition	Effect
Calibration PAA not possible! Probe slope too low	PAA slope too low ( $<25\%$ of norm slope)	Calibrate again
Calibration PAA not possible! Probe slope too high	PAA slope too high ( $>300\%$ of norm slope)	Calibrate again
PAA value too low PAA $> x.xx$ ppm	PAA $<2\%$ of measuring range	
Zero point too low Zero point too high	$< 3.7$ mA $> 5$ mA	Check probe/cable Repeat calibration in PAA-free water

# Complete Operating Menu / Description

## Measuring Range

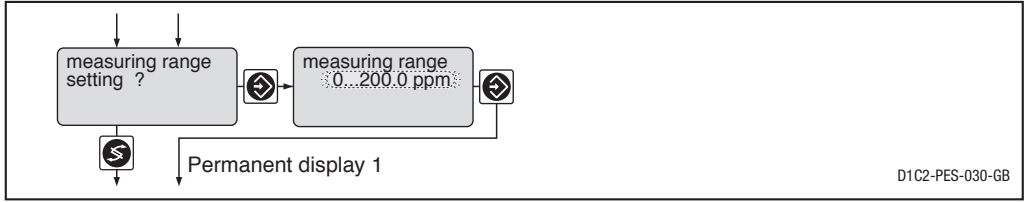

	Initial value	Possible values		Remarks
		Increment	Lower value	
Measuring range	0...200 ppm	0...200 ppm 0...2000 ppm		



### IMPORTANT

**If the area allocation is changed, the PAA probe must be re-calibrated and all the menu settings must be checked!**

## Measured Value

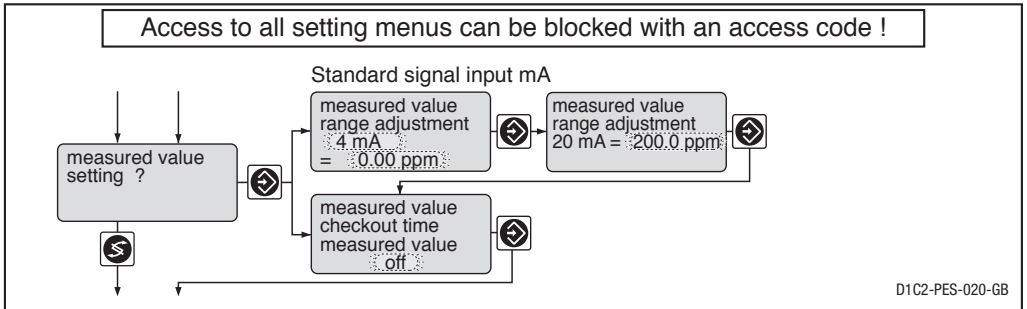

### IMPORTANT

**If the area allocation is changed, the PAA probe must be re-calibrated and all the menu settings must be checked!**

## Checkout Time Measured Value



### IMPORTANT

**This function must not be enabled with applications where it can be assumed that the measured value does not change.**

This function checks whether the measured value from the probe (at the measured value input) changes within the “measured value checkout time”. It is assumed that it will change with an intact probe. If the measured value does not change during this check time, the DULCOMETER® D1C sets the controller output to “0” and the alarm relay drops off. The “Check PAA probe” message, for example, appears in the LCD display.

# Complete Operating Menu / Description

	Initial value	Possible values			Remarks
		Increment	Lower value	Upper value	
Standard signal input lower signal limit	4 mA	0 mA 4 mA			
Allocated measured value lower	0.00 ppm	0.1 ppm	-20.0 ppm	220.0 ppm	
	0.00 ppm	1 ppm	-200 ppm	2200 ppm	
upper	200.0 ppm	0.1 ppm	-20.0 ppm	220.0 ppm	
	2000 ppm	1 ppm	-200 ppm	2200 ppm	
Checkout time	off	1 s	1 s	9999 s	Constant measurement signal results in message and alarm. Function off = 0 s

## Correction variable\*

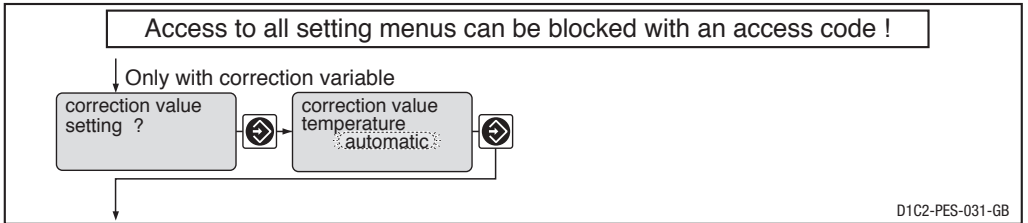

\* In the setting menu “correction value” for this equipment enables you to display the temperature or to maintain an mA signal proportional to the temperature. No temperature adjustment is made to the measured variable!

## Pumps

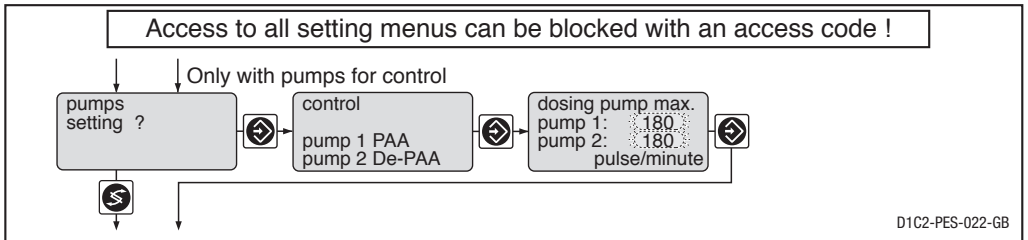

	Initial value	Possible values			Remarks
		Increment	Lower value	Upper value	
Max. stroke/minute of pumps 1 and 2	180	1	1	500	off = 0 strokes/min

# Complete Operating Menu / Description

## Relay for power control

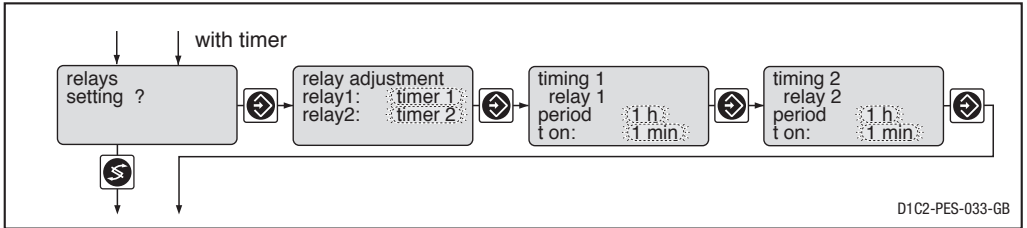
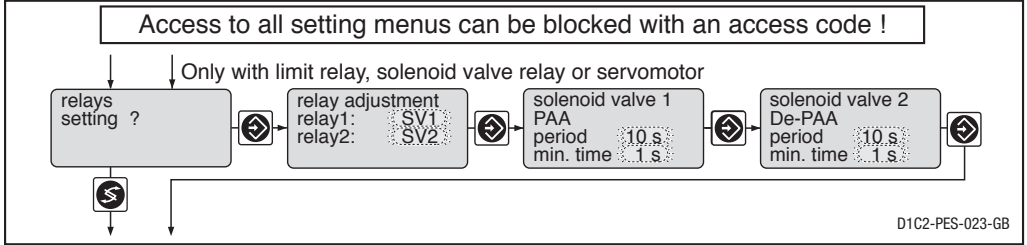

	Initial value	Possible values			Remarks
		Increment	Lower value	Upper value	
Relay adjustment	as per identity code				
Relay 1		Solenoid valve 1 Limit value 1* Actuator 1 Timer 1 Servomotor off			*For "limit value", the relays remain active, even in the event of a fault. only with servomotor
Relay 2		Solenoid valve 2 Limit value 2* Actuator 2 Timer 2 off			
Period (Cycle)	10 s	1 s	10 s	9999 s	
min. time	1 s	1 s	1 s	Cycle/2	
Period ( Cycle) t on	off 1 min	1 h 1 min	1 h / off 1 min	240 h 60 min	for solenoid valve for solenoid valve  Set here the smallest permitted operating factor of the connected device.  for timer for timer

### NOTE

*The limit value relay can be defined in such a way as to respond as a control element, i.e. if a limit value relay closes a circuit, it opens when a pause contact is activated and/or for a subsequent delay period  $t_d$  (if  $t_d$  is set to  $> 0$  min in "General settings").*

# Complete Operating Menu / Description

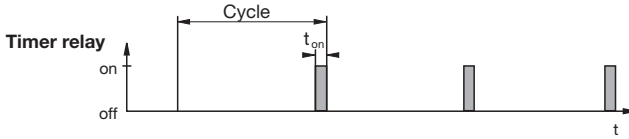

## IMPORTANT

**The timer will be reset if there is a drop in the power supply.**

At the end of the (timer) cycle time the DULCOMETER® D1C closes the assigned relay for the duration of “t on” (timer). “Pause” interrupts the timer.

When the clock is shown in the LC display the timer can be reset to the start of the cycle at precisely this point using the enter button.

The % figure in the LC display indicates the progress of the current cycle.

Timer relays may be used, e.g. for shock metering or sensor cleaning.

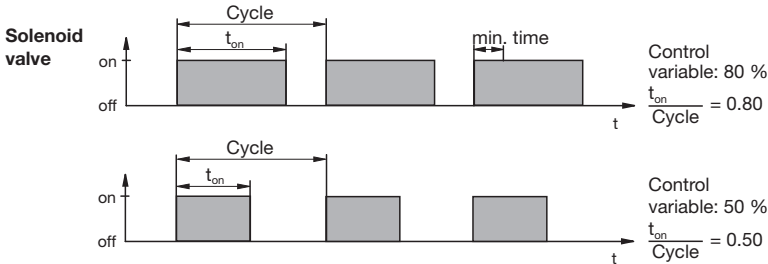

The switching time of the DULCOMETER® D1C (solenoid valve) depends on the actuating variable and the “min. time” (smallest permitted operating factor of the connected device).

The actuating variable determines the ratio  $t_{on}/\text{cycle}$  and thus the switching times (see fig. above).

The “min. time” influences the switching times in two situations:

a) theoretical switching time < min. time:

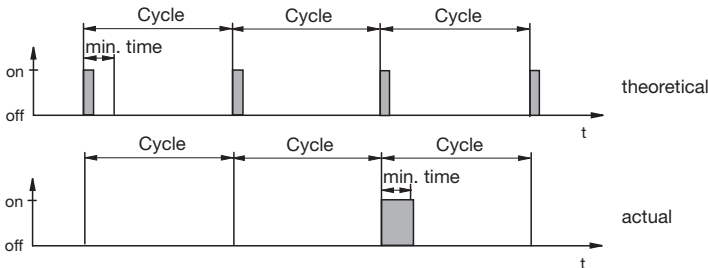

The DULCOMETER® D1C does not switch for a certain number of cycles until the sum of the theoretical switching times exceeds the “min. time”. Then the DULCOMETER® D1C switches for the duration of this total time.

# Complete Operating Menu / Description

b) theoretical switching time > (cycle - min. time) and calculated switching time < cycle

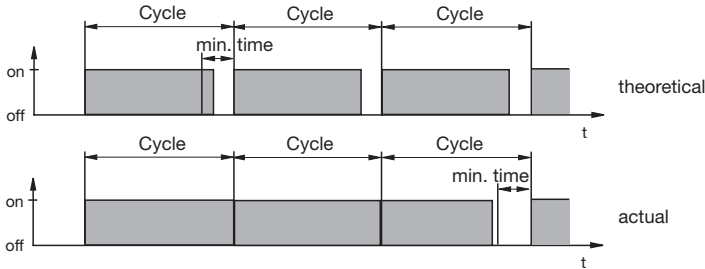

The DULCOMETER® D1C does not deactivate for a certain number of cycles until the differences between cycle and theoretical switching time exceed the “min. time”.

## Limit values

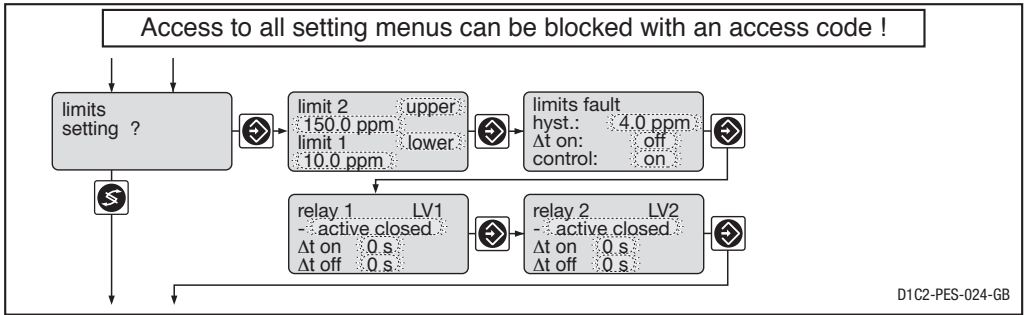

	Initial value	Possible values			Remarks
		Increment	Lower value	Upper value	
Type of limit transgression		upper			Limit transgression when exceeding or dropping below value *only with limit relay
Limit 1:	lower	lower			
Limit 2:	upper	off*			
Limit value	Limit 1: 10.0 ppm Limit 2: 150.0 ppm	0.1 ppm	-20.0 ppm	220.0 ppm	
Limit value	Limit 1: 100 ppm Limit 2: 1500 ppm	1 ppm	-200 ppm	2200 ppm	
Hysteresis limits	4.0 ppm 40 ppm	0.1 ppm 1 ppm	0 ppm 0 ppm	220.0 ppm 2200 ppm	Effective in direction of “Cancelling limit transgression”
Checkout time limits Δt on	off	1 s	1 s	9999 s	Results in message and alarm. off = 0 s: Function switched off, no message, no alarm
Control	on	on off			
Switching direction	active closed	active closed			Acts as N/O
Limit value 1; Limit value 2		active open			Acts as N/C
Switch-on delay Δt on	0 s	1 s	0 s	9999 s	
Switch-off delay Δt off	0 s	1 s	0 s	9999 s	

# Complete Operating Menu / Description

If the limit is exceeded for longer than the “Delay time - limit values” an error message is given, which must be acknowledged, and the alarm relay circuit is broken. If “Controller” is also set to “off” the control process stops.

## Servomotor

The **operating range** is defined by the total resistance range of the feedback potentiometer. The maximum limit of the range actually used is set by defining the **control range**.



### CAUTION

- **Activation of the servomotor must be carried out with the same meticulous care as taken when calibrating a measuring probe.**
- **To ensure correct operation, the activation time of the actuator used should not be less than 25 seconds for the control range from 0...100 %!**

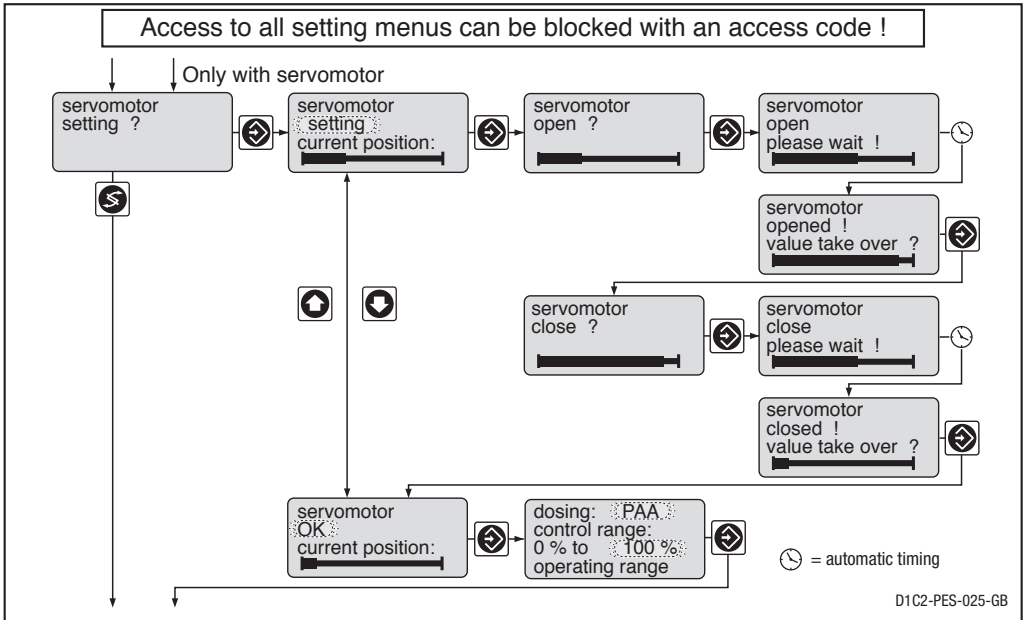

	Initial value	Possible values			Remarks
		Increment	Lower value	Upper value	
Servomotor	setting	setting ok off			
Control direction	PAA	PAA De-PAA			
Control range	100 %	1 %	10 %	100 %	in % of operating range

### NOTE

- **When the wide bar is as far right as it will go the stroke adjustment motor is fully open.**
- **The permanent display shows to what degree the motor has opened in % (the greater the percentage, the farther open the stroke adjustment motor).**

# Complete Operating Menu / Description

## Control

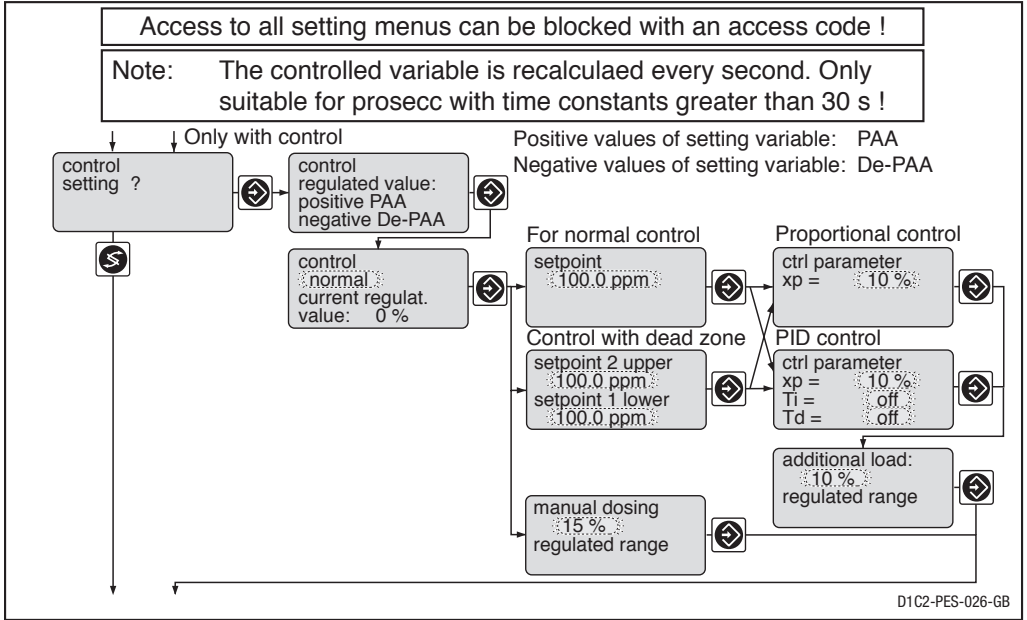

	Initial value	Possible values			Remarks
		Increment	Lower value	Upper value	
Control	normal	normal with dead zone manual			When controlling with dead zone, the regulated value is not used for measured values within the dead zone.
Setpoint setting	100.0 ppm 1000 ppm	0.1 ppm 1 ppm	lower measurement threshold	upper measurement threshold	2 setpoints necessary for control with dead zone. Setpoint 2 ≥ Setpoint 1
Control parameter xp	10 %	1 %	1 %	500 %	xp referred to measuring range
Control parameter Ti	off	1 s	1 s	9999 s	Function off = 0 s
Control parameter Td	off	1 s	1 s	2500 s	Function off = 0 s
Additional basic load	0 %	1 %	-100 %	+100 %	
Manual metering	0 %	1 %	-100 %	+100 %	

### Abbreviations for control variables:

$x_p$ : 100 %/Kp (inverse proportional coefficient)

$T_i$ : Integration time of I-controller [s]

$T_d$ : Differential time of D-controller [s]

# Complete Operating Menu / Description

## Feed forward control

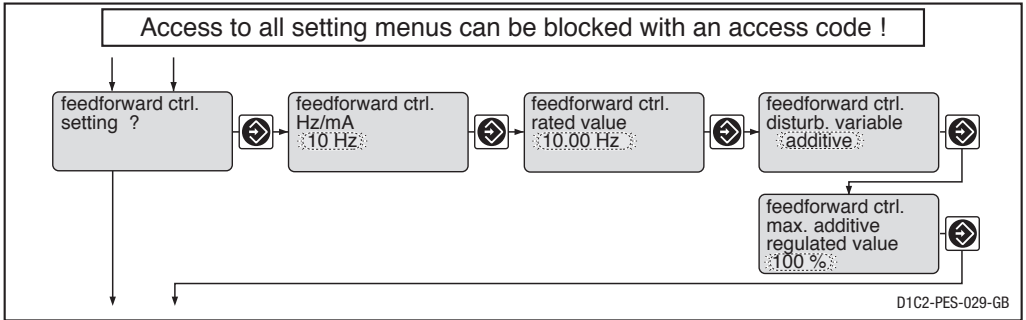

	Initial value	Possible values			Remarks
		Increment	Lower value	Upper value	
Feed forward control (Flow)	as per identity code	None 10 Hz 500 Hz			Signal processing: Signal <0.02 Hz = No flow Signal <0.2 Hz = No flow Signal <0.2 mA = No flow Signal <4.2 mA = No flow  Depended on signal type. Maximum limitation of range used.
	at standard signal: 4–20 mA	0...20 mA 4...20 mA			
Feed forward control rated value	10 Hz 500 Hz 20 mA	0.01 Hz 1 Hz 0.1 mA	0.1 Hz 1 Hz 0/4 mA	10 Hz 500 Hz 20 mA	
Feed forward control effect	multiplicative	multiplicative additive			
Max. add. regulated value	100 %	1 %	-500 %	+500 %	

## Standard Signal Output 1

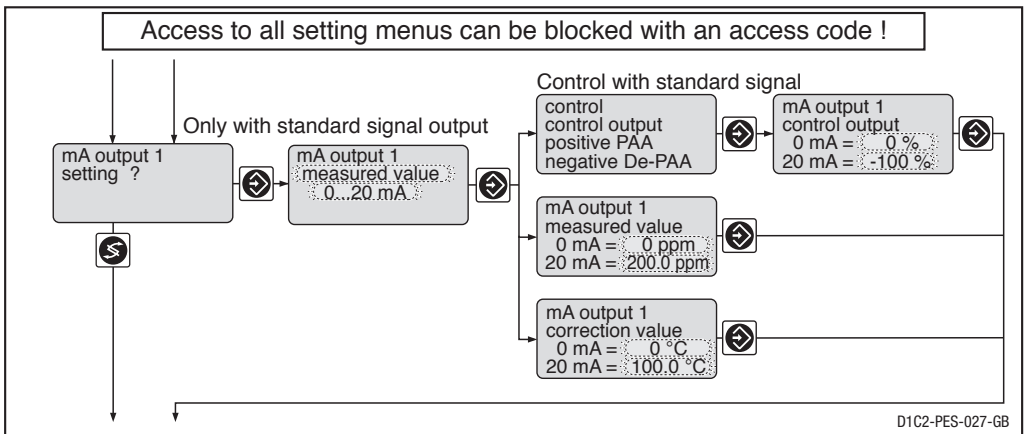

# Complete Operating Menu / Description

## Standard Signal Output 2

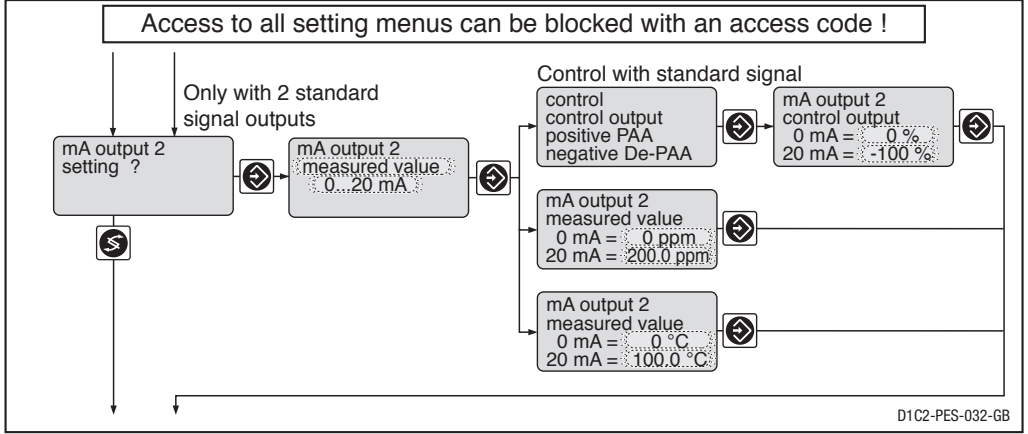

	Initial value	Possible values			Remarks
		Increment	Lower value	Upper value	
Variable allocation	as per identity code	Measured value Controlled variable Correction value			If control is present only with correction variable
Output range	0...20 mA	0...20 mA 4...20 mA 3.6/4-20 mA			Reduction to 3.6 mA when alarm relay switches (not limit value violation)
Range measured value	0...200.0 ppm 0...2000 ppm	0.1 ppm 1 ppm	-20.0 ppm -200 ppm	220.0 ppm 2200 ppm	Minimum range 1 %
Range controlled variable	-100 %...0 %	1 %	-100 %	+100 %	Minimum range 1 %
Range correction value	0...100 °C	0.1 °C	0 °C	100 °C	Minimum range 1 °C

# Complete Operating Menu / Description

## General setting

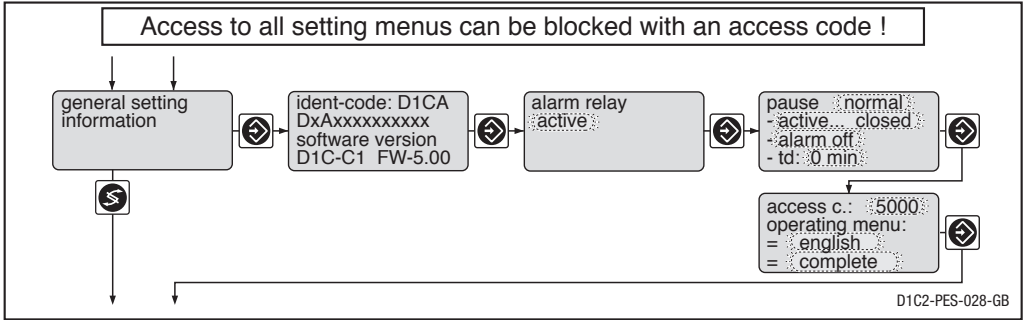

	Initial value	Possible values			Remarks
		Increment	Lower value	Upper value	
Alarm relay	active	active not active			
Pause	normal	normal hold			
Control input pause	active closed	active closed active open			acts as N/O acts as N/C
Pause alarm	alarm off	alarm off alarm on			Alarm relay can be activated by pause contact.
td	0 min	1 min	0 min	60 min	
Access code	5000	1	1	9999	
Language	as per identity code	as per identity code			
Operating menu	complete	restricted complete			

---

## Complete Operating Menu / Description

---

### Standard Pause

If the pause-switch is off, the DULCOMETER® D1C sets the operating outputs to “0” for as long as the pause-switch is off or for a set time-delay  $t_d$  (if  $t_d$  is set to  $> 0$  min). Whilst the pause-switch is off, the D1C establishes the P-proportion in the background.

With PID-control (Identity code characteristics “control characteristic” = 2): the I-proportion is stored when the pause is switched off (I-proportion then usually only present if  $T_i > 0$  has been selected in the “Control setting?” setting menu).

Exception: the standard signal outputs mA for the measured value or correction value are not affected by the pause.

After pause is activated the operating outputs remain at “0” for the length of the time-delay  $t_d$ . The time-delay  $t_d$  must be set up in such a way that, in this time e.g. sample water (process-specific current concentration) flows to the sensor.

With PID-control (Identity code characteristics “control characteristic” = 2): The control variable output resulting from the pause and the expiry of the time-delay  $t_d$  is reconciled jointly with the current P-component and (if  $T_i$  is set  $> 0$ ) with the stored I-component.

### Pause Hold

If the pause-switch is off, the DULCOMETER® D1C freezes the operating output at the most recent value for as long as the pause-switch is off or for a set time-delay  $t_d$  (if  $t_d$  is set to  $> 0$  min). Whilst the pause-switch is off, the D1C establishes the P-proportion in the background.

With PID-control (Identity code characteristics “control characteristic” = 2):

Even the mA standard signal outputs for measured value or correction value are frozen.

After pause is activated the operating outputs remain frozen for the length of the time delay  $t_d$ . The time delay  $t_d$  must be set up in such a way that, in this time e.g. sample water (process-specific current concentration) flows to the sensor.

With PID-control (Identity code characteristics “control characteristic” = 2): The control variable output resulting from the pause and the expiry of the time-delay  $t_d$  is reconciled jointly with the current P-proportion and (if  $T_i$  is set  $> 0$ ) with the newly established I-proportion.

### Access Code

Access to the setting menu can be prevented by setting up an access code. The DULCOMETER® D1C controller is supplied with the access code 5000 which permits free access to the setting menu. The calibration menu remains freely accessible even when access to the setting menu is blocked by the code.

## 9 Fault / Remarks / Troubleshooting

Fault	Fault text	Symbol	Effect on metering	Effect on control	Alarm with ack- nowledgement	Remarks	Remedy
<b>Measured value</b> Checkout time measured value exceeded	<i>Check PAA probe</i>	€	Basic load	Stop	Yes	Function defeatable	Check function of probe, extend check time
Signal exceeded/drops below value	<i>PAA input &lt; 3 mA PAA input &gt; 23 mA PAA calib. defective</i>	€	Basic load	Stop	Yes	Signal <3.0 ±0.2 mA or >23 ±0.2 mA	Check probe, transducer and cable connection
Calibration probe with error		€	Basic load	Stop	No	Metering continues in case of error with unsteady measured values	Check probe, replace if necessary, recalibrate if necessary
<b>Correction variable</b> Signal exceeded/drops below value	<i>temp. input ↑↓</i>	€			yes	Pt100- signal > 138.5 Ω Signal <3.0 ±0.2 mA or >23 ±0.2 mA Value last valid is used	Check probe, transducer and cable connection
<b>Feed forward control</b> Signal drops below value multiplicative additive Signal exceeded	<i>feedfwd. &lt; 4 mA feedfwd. &gt; 23 mA</i>	€	Stop		Yes Yes	Signal <3.8 ±0.2 mA or >23 ±0.2 mA Value last valid is used	Check probe, transducer and cable connection
<b>Limit transgression</b> after checkout time limit value Control "on" Control "off"	<i>PAA limit 1 PAA limit 2</i>	€	Stop or Basic load	Stop	Yes Yes	Function defeatable	Define cause, reset values if necessary
<b>Servomotor</b> Position not reached	<i>Servomotor defective</i>	€			Yes	Servomotor closes	Check servomotor
<b>Electronics error</b>	<i>System error</i>	€	Stop	Stop	Yes	Elektronik data defective	Call in service

# Fault / Remarks / Troubleshooting

Operation	Note text	Symbol	Effect		Alarm with acknowledgement	Remarks	Remedy
			on metering	on control			
Pause contact	Pause	EO	Stop	Stop	No/Yes*	No further fault check	-
	Pause/Hold	E		PI-part frozen			
Stop button	Stop	EO	Stop	Stop	No	Relay drops out	-
During calibration probe			Basic load + Feed forward control	Stop in complete operating menu	No	No error processing of measured variable	-
	Probe slope too low	E	Basic load	Stop	No	25% > probe of slope > 300% norm slope	Check probe, replace if necessary
Probe slope too high	Slope low Slope high	E	Basic load	Stop	No	< 2 % from meas. range	Check probe/cable Repeat calibration in PAA-free water
PAA-value <2 % measuring range	PAA too low						
Zero point	Zero point low Zero point high	E	Basic load	Stop	No	Signal < 3 mA Signal > 5 mA	Check probe/cable Repeat calibration in PAA-free water
During servomotor setting	Position feed back wrong					Without correct adjustment the last valid values are still used	Check connection of relay, potentiometer
	Upper position <40 % max. value	Direction check Final value small					Adjust the operation region of the servomotor correctly
	Lower position >30 % range	Final value big					

\*dependent on whether "Alarm on" or "Alarm off" is set in "General settings"



