



Operating Instructions

DULCOMETER® D1C

Part 2: Adjustment and Operation,
Measured Variable Conductive Conductivity

D1C2-Leit.-001-GB



Type D

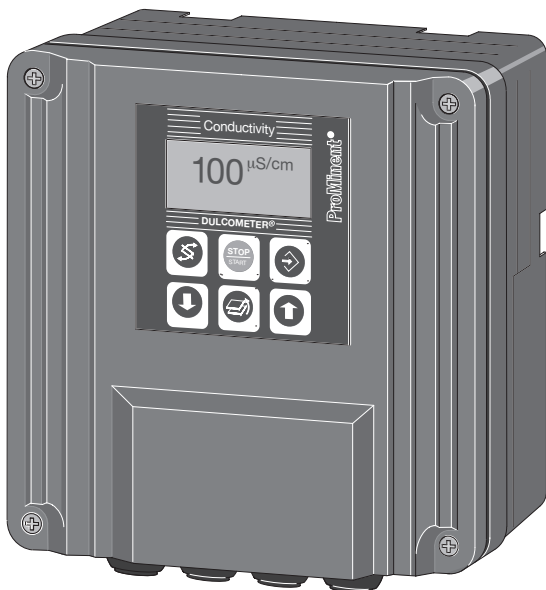

Type W

D1C A

Please enter the identity code of your device here!

**Please completely read through the operating instructions! · Do not discard!
The warranty shall be invalidated by damage caused by operating errors!**

2 General User Information

	Page
1 Device Identification / Identity Code	2
2 General User Information	3
3 Device Overview / Controls	4
4 Functional Description	5
5 Display Symbols	6
6 Operation diagram	7
7 Restricted Operating Menu	8
Overview	8
Description	9
8 Complete Operating Menu	13
Overview	13
Description	14
9 Fault / Remarks / Troubleshooting	30

General User Information

These operating instructions describe the technical data and function of the series DULCOMETER® D1C controller, provide detailed safety information and are divided into clear steps.



IMPORTANT

- ***Please observe the parts of these operating instructions applicable to your particular version! This is indicated in the Section “Device Identification / Identity Code”!***
- ***Correct measuring and metering is only possible in the case of impeccable operation of the sensor. The sensor has to be calibrated / checked regularly!***

NOTE

A form “Documentation of controller settings type D1C” is available under www.prominent.com/documentation_D1C for the purpose of documenting the controller settings.

3 Device Overview / Controls

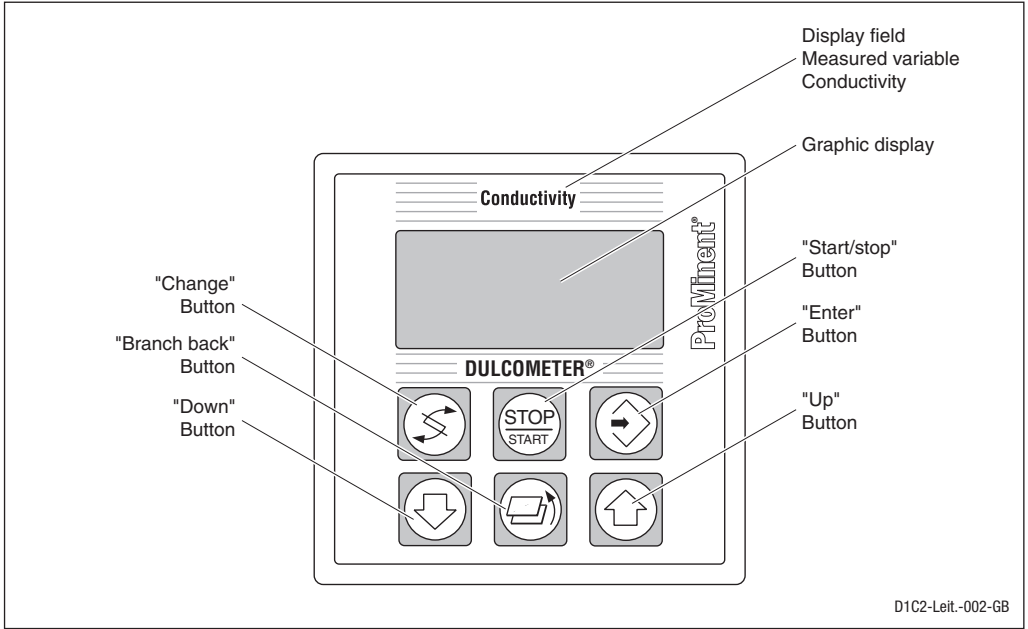

D1C2-Leit.-002-GB

	<p>CHANGE button</p> <p>To change over within a menu level and to change from one variable to another within a menu point.</p>
	<p>START/STOP button</p> <p>Start/stop of control and metering function.</p>
	<p>ENTER button</p> <p>To accept, confirm or save a displayed value or status. For alarm acknowledgement.</p>

	<p>UP button</p> <p>To increase a displayed numerical value and to change variables (flashing display)</p>
	<p>BRANCH BACK button</p> <p>Back to permanent display or to start of relevant setting menu.</p>
	<p>DOWN button</p> <p>To decrease a displayed numerical value and to change variables (flashing display).</p>

4 Functional Description

NOTE

Please refer to the description of the complete operating menu in Section 8 for a detailed description of the individual characteristics of the DULCOMETER® D1C controller!

4.1 Operating Menu

The D1C controller permits settings to be made in two different menus. All values are preset and can be changed in the **complete operating menu**.

The controller is delivered with a **restricted operating menu** so that the D1C controller can be used effectively in many applications from the very onset. If adaptations prove to be necessary, all relevant parameters can then be accessed by switching over to the complete operating menu.

4.2 Access Code

Access to the setting menu can be prevented by setting up an access code. The D1C controller is supplied with the access code 5000 which permits free access to the setting menu. The calibration menu remains freely accessible even if access to the setting menu is blocked by the code.

4.3 Control

The D1C can operate as a proportional controller or as a PID controller - depending on the device version (see identity code) and the setting.

The controlled variable is recalculated once a second. Control procedures which require rapid correction of setpoint deviations (less than approx. 30 seconds) cannot be processed with this controller. The cycle times must be taken into consideration when activating solenoid valves (pulse length) in the same way as their running times when activating servomotors (3-point).

Via the control input pause, the control function (selection of controlled variable) can be switched off. The calculation of the controlled variable starts again after cessation of „pause“.

4.4 Feed Forward Control

The D1C controller can process a signal of a feed forward control. Depending on the device version (see identity code) and the setting, this signal can be obtained in any form of a 0–20 mA or 4–20 mA signal or as a digital contact signal with the maximum frequencies 10 Hz or 500 Hz.

This signal can be used, for example, for flow-proportional metering (multiplicative effect) or feed forward-dependent basic load metering (additive effect). The result of control variable calculation from the proportional or PID control is multiplied by or added to the feed forward signal. A multiplicative feed forward variable at the level of the set rated value carries over the calculated control variable unchanged into the controlled variable:

$$\text{Controlled variable} = \text{Feed forward variable} / \text{rated value} \times \text{calculated control variable}$$

During start-up, the zero point has to be checked. The multiplicative feed forward control is not designed for switching off permanently the actuating variable (signal \approx 0).

An additive feed forward variable at the level of the rated value results in maximum controlled variable:























$$\text{Controlled variable (max. 100 \%)} = \text{Feed forward variable} / \text{rated value} \times \text{max. controlled variable} + \text{calculated control variable}$$

4.5 Error Messages

Error messages and information are indicated on the bottom line in the permanent display 1. Errors to be acknowledged (acknowledgement switches off the alarm relay) are indicated by the symbol „E“. Errors/notes which still apply after acknowledgement are indicated alternately. Faults which are rectified of their own accord due to changed operating situations are removed from the permanent display without the need for acknowledgement.

5 Display Symbols

The display of the DULCOMETER® D1C controller uses the following symbols:

Description	Comment	Symbol
Limit value transgression Relay 1, upper	Symbol left	
Relay 1 lower	Symbol left	
Relay 2 upper	Symbol right	
Relay 2 lower	Symbol right	
Metering pump 1 (Increase conductivity) Control off	Symbol left	
Control on	Symbol left	
Metering pump 2 (Reduce conductivity) Control off	Symbol right	
Control on	Symbol right	
Solenoid valve 1 (Increase conductivity) Control off	Symbol left	
Control on	Symbol left	
Solenoid valve 2 (Reduce conductivity) Control off	Symbol right	
Control on	Symbol right	
Servomotor Control, open relay		 
Control, close relay		 
Without control		 
Position feedback	Thickness of bar increases from left to right during opening	
Stop button pressed		
Manual metering		
Fault		

6 Operation diagram

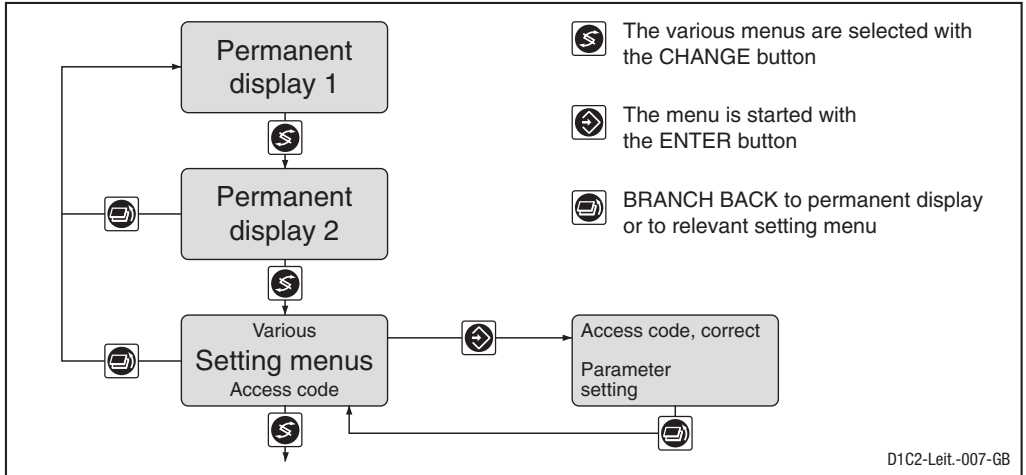

NOTE

Access to the setting menus can be barred with the access code!

The number and scope of setting menus depends on the device version!

If the access code is selected correctly in a setting menu, the following setting menus are also accessible!

If within a period of 10 minutes no button is pushed, the unit automatically branches back from the calibrating menu or a setting menu to the permanent display 1.

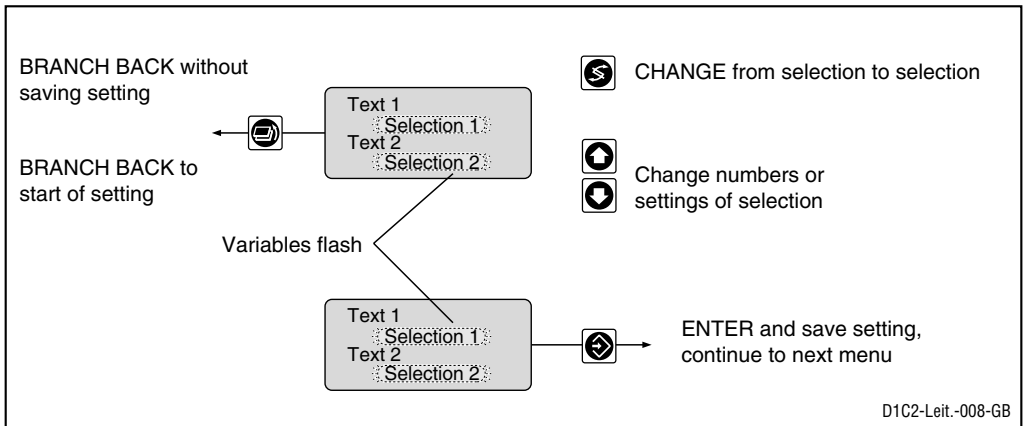

7 Restricted Operating Menu / Overview

The restricted operating menu permits simple operation of the most important parameters. The following overview shows the settings which can be selected:

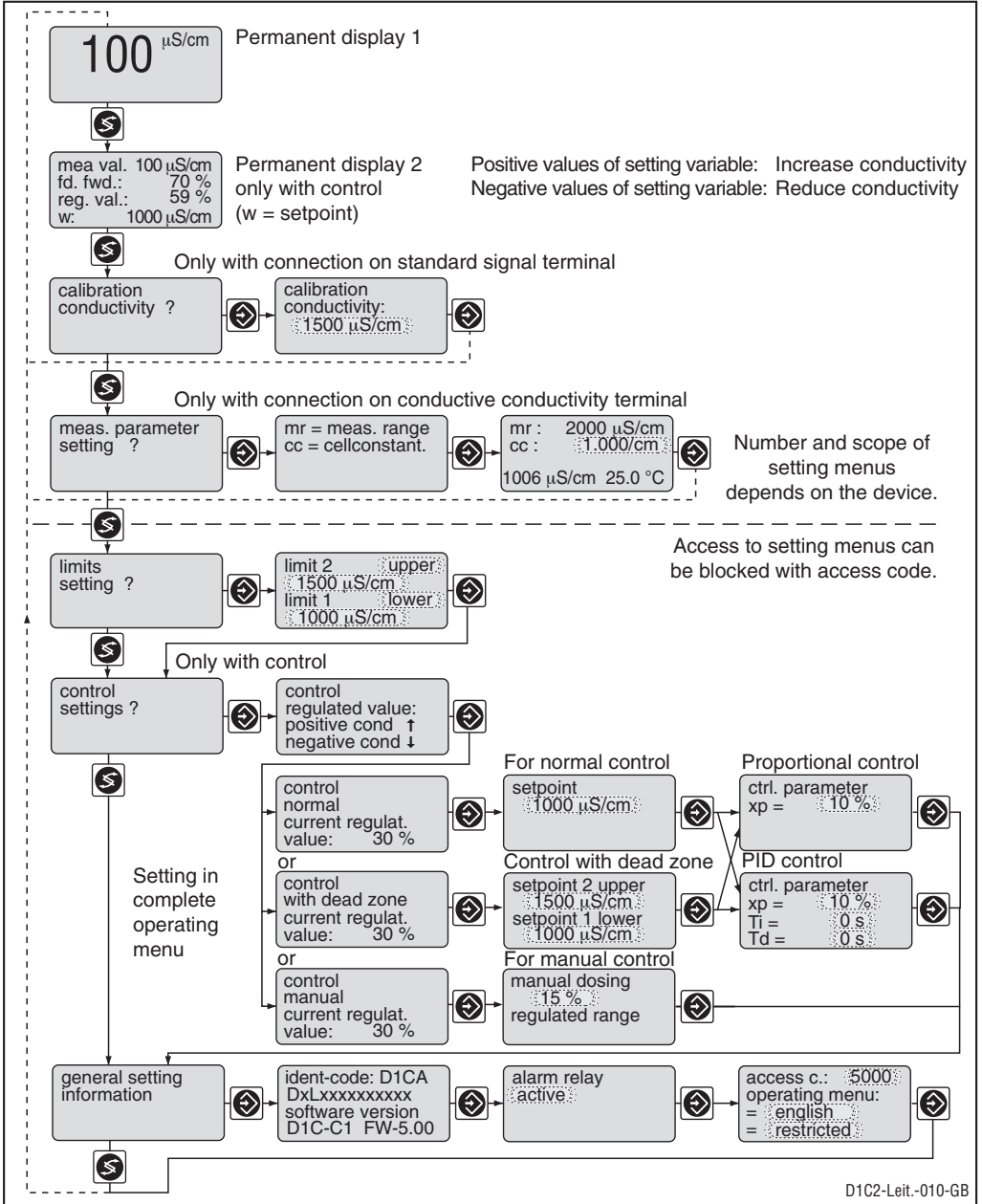

Restricted Operating Menu / Description

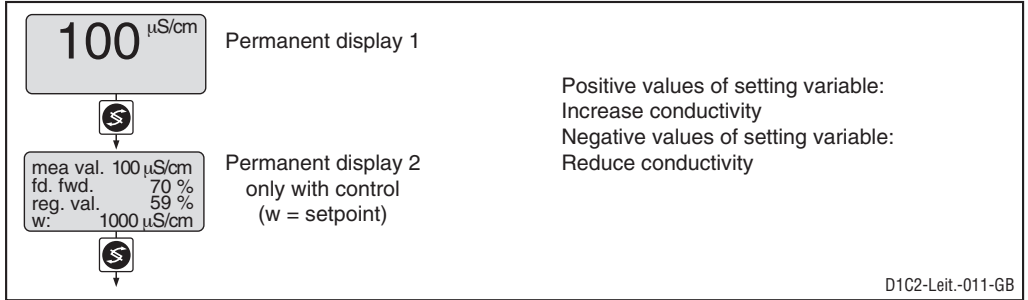

Calibration conductivity (only for connected terminal standard signal)

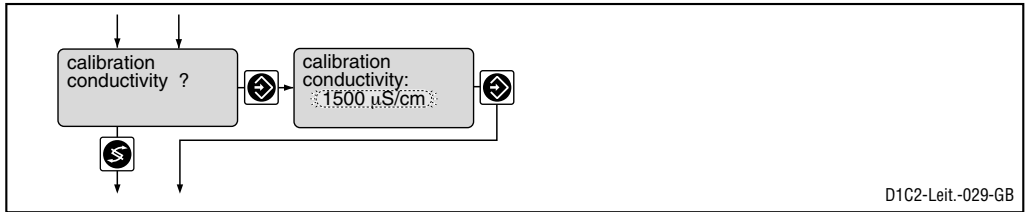

During calibration, the D1C sets the command outputs to “0”. Exception: if a basic load or a manual control output were set, these are maintained during calibration. The standard signal outputs mA (measuring value or correction value) are frozen.

The actually measured value will be proposed; this value is adjustable (arrow keys). On successful completion of calibration, all error checks which refer to the measured value are restarted.

	Initial value	Possible values		
		Increment	Lower value	Upper value
Calibration conductivity	measured value	as per measuring range	as per measuring range	as per measuring range

Error message	Condition effect	Remarks
Measured value too low Value > xx mS/cm Check measuring range	Value < 2 % of measuring range	Check measuring range
Measured value too high Value < xx mS/cm Check measuring range	Value > 100 % of measuring range	Check measuring range

Restricted Operating Menu / Description

Calibration conductivity (only for connected terminal conductive conductivity)

Measuring parameter

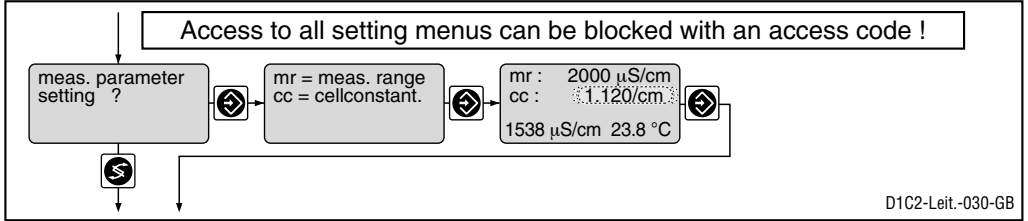

	Initial value	Possible values			Remarks
		Increment	Lower value	Upper value	
Cell constant cc	1.000/cm	0.0001/cm 0.001/cm 0.01/cm	0.0060/cm 0.150/cm 1.50/cm	0.1499/cm 1.499/cm 12.00/cm	cc can be adjusted for all mr over the complete area

The measured value can be adjusted to the actual conductivity value by changing the cell constants (arrow keys).

NOTE

The following menus apply generally!

Limit values

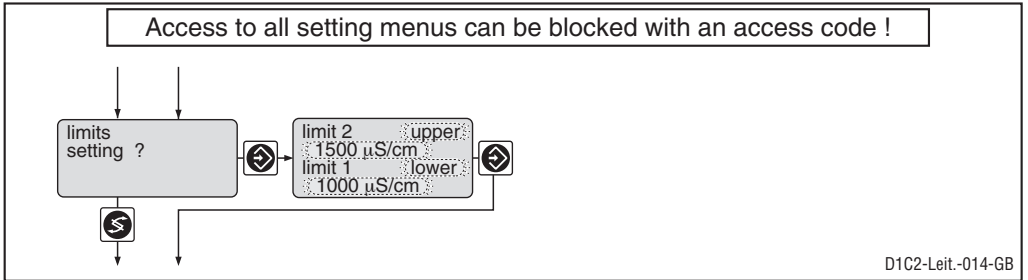

	Initial value	Possible values			Remarks
		Increment	Lower value	Upper value	
Type of limit transgression	Limit 1: lower Limit 2: upper	lower upper off**			**only with limit value relay Measuring range 20 µS/cm
Limit value	Limit 1: 10 µS/cm Limit 2: 15 µS/cm	0.01 µS/cm	-1 µS/cm	21 µS/cm	
	Limit 1: 25 µS/cm Limit 2: 37.5 µS/cm	0.01 µS/cm	-2.5 µS/cm	52.5 µS/cm	Measuring range 50 µS/cm*
	Limit 1: 100 µS/cm Limit 2: 150 mS/cm	0.1 µS/cm	-10 µS/cm	210 µS/cm	Measuring range 200 µS/cm

Restricted Operating Menu / Description

	Initial value	Possible values			Remarks
		Increment	Lower value	Upper value	
Limit 1:	250 $\mu\text{S}/\text{cm}$	0.1 $\mu\text{S}/\text{cm}$	-25 $\mu\text{S}/\text{cm}$	525 $\mu\text{S}/\text{cm}$	Measuring range 500 $\mu\text{S}/\text{cm}^*$
Limit 2:	375 $\mu\text{S}/\text{cm}$				
Limit 1:	1000 $\mu\text{S}/\text{cm}$	1 $\mu\text{S}/\text{cm}$	-100 $\mu\text{S}/\text{cm}$	2100 $\mu\text{S}/\text{cm}$	Measuring range 2000 $\mu\text{S}/\text{cm}$
Limit 2:	1500 $\mu\text{S}/\text{cm}$				
Limit 1:	2500 $\mu\text{S}/\text{cm}$	1 $\mu\text{S}/\text{cm}$	-250 $\mu\text{S}/\text{cm}$	5250 $\mu\text{S}/\text{cm}$	Measuring range 5000 $\mu\text{S}/\text{cm}^*$
Limit 2:	3750 $\mu\text{S}/\text{cm}$				
Limit 1:	10 mS/cm	0.01 mS/cm	-1 mS/cm	21 mS/cm	Measuring range 20 mS/cm
Limit 2:	15 mS/cm				
Limit 1:	100 mS/cm	0.1 mS/cm	-10 mS/cm	210 mS/cm	Measuring range 200 mS/cm
Limit 2:	150 mS/cm				
Limit 1:	500 mS/cm	1 mS/cm	-50 mS/cm	1050 mS/cm	Measuring range 1000 mS/cm*
Limit 2:	750 mS/cm				

* = only for connected terminal standard signal

Control

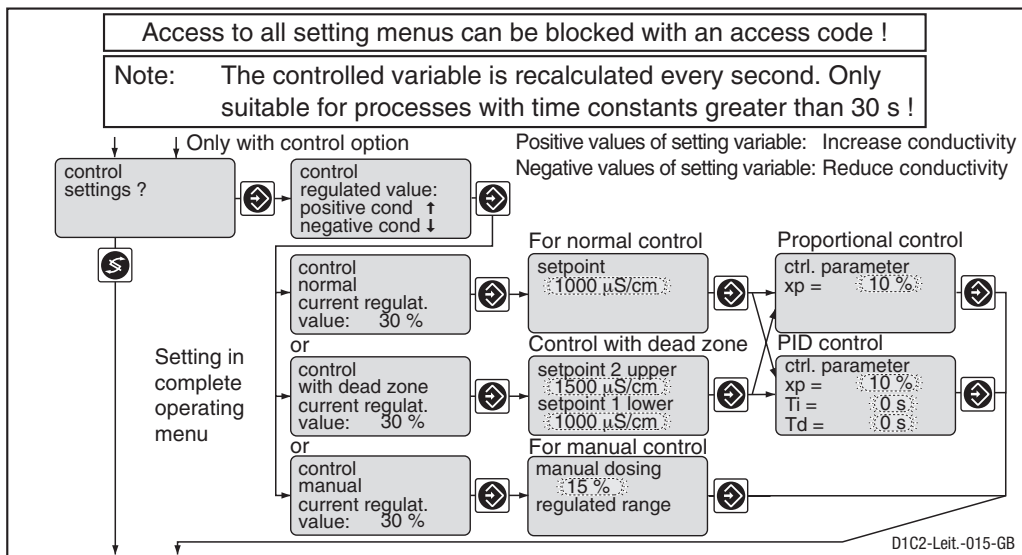

	Initial value	Possible values			Remarks
		Increment	Lower value	Upper value	
Setpoint	10 $\mu\text{S}/\text{cm}$	0.01 $\mu\text{S}/\text{cm}$	-1 $\mu\text{S}/\text{cm}$	21 $\mu\text{S}/\text{cm}$	Measuring range 20 $\mu\text{S}/\text{cm}$
	15 $\mu\text{S}/\text{cm}$	0.01 $\mu\text{S}/\text{cm}$	-2.5 $\mu\text{S}/\text{cm}$	52.5 $\mu\text{S}/\text{cm}$	Measuring range 50 $\mu\text{S}/\text{cm}^*$
	100 $\mu\text{S}/\text{cm}$	0.1 $\mu\text{S}/\text{cm}$	-10 $\mu\text{S}/\text{cm}$	210 $\mu\text{S}/\text{cm}$	Measuring range 200 $\mu\text{S}/\text{cm}$
	250 $\mu\text{S}/\text{cm}$	0.1 $\mu\text{S}/\text{cm}$	-25 $\mu\text{S}/\text{cm}$	525 $\mu\text{S}/\text{cm}$	Measuring range 500 $\mu\text{S}/\text{cm}^*$
	1000 $\mu\text{S}/\text{cm}$	1 $\mu\text{S}/\text{cm}$	-100 $\mu\text{S}/\text{cm}$	2100 $\mu\text{S}/\text{cm}$	Measuring range 2000 $\mu\text{S}/\text{cm}^*$
	2500 $\mu\text{S}/\text{cm}$	1 $\mu\text{S}/\text{cm}$	-250 $\mu\text{S}/\text{cm}$	5250 $\mu\text{S}/\text{cm}$	Measuring range 5000 $\mu\text{S}/\text{cm}^*$
	10 mS/cm	0.01 mS/cm	-1 mS/cm	21 mS/cm	Measuring range 20 mS/cm
	100 mS/cm	0.1 mS/cm	-10 mS/cm	210 mS/cm	Measuring range 200 mS/cm
	500 mS/cm	1 mS/cm	-50 mS/cm	1050 mS/cm	Measuring range 1000 mS/cm*

Restricted Operating Menu / Description

	Initial value	Possible values			Remarks
		Increment	Lower value	Upper value	
Control parameter xp	10 %	1 %	1 %	500 %	2 setpoints necessary for control with dead zone. Setpoint 1 < setpoint 2
Control parameter Ti	off	1 s	1 s	9999 s	Adjustment of measuring range on page 15/18
Control parameter Td	off	1 s	1 s	2500 s	xp referred to measuring range
Manual metering	0 %	1 %	-100 %	+100 %	Function off = 0 s Function off = 0 s

* = only for connected terminal standard signal

Abbreviations for control variables:

x_p = 100 %/Kp (inverse proportional coefficient)

T_i = I controller integration time [s]

T_d = D controller differential time [s]

General settings

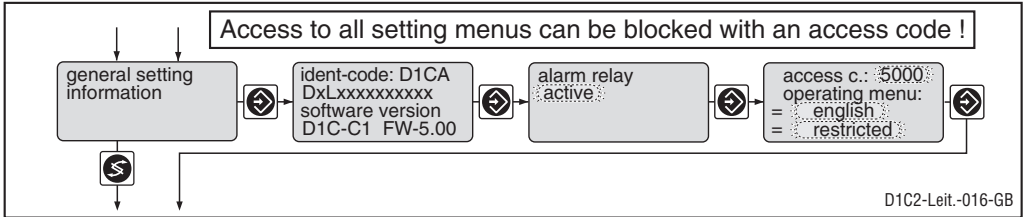

	Initial value	Possible values			Remarks
		Increment	Lower value	Upper value	
Alarm relay	active	active not active			
Access code	5000	1	1	9999	
Language	as per identity code	as per identity code			
Operating menu	restricted	restricted complete			

Access Code

Access to the setting menu can be prevented by setting up an access code. The DULCOMETER® D1C controller is supplied with the access code 5000 which permits free access to the setting menu. The calibration menu remains freely accessible even when access to the setting menu is blocked by the code.

8 Complete Operating Menu / Overview

All parameters of the controller can be set in the complete operating menu (access see previous page). The following overview shows the settings which can be selected:

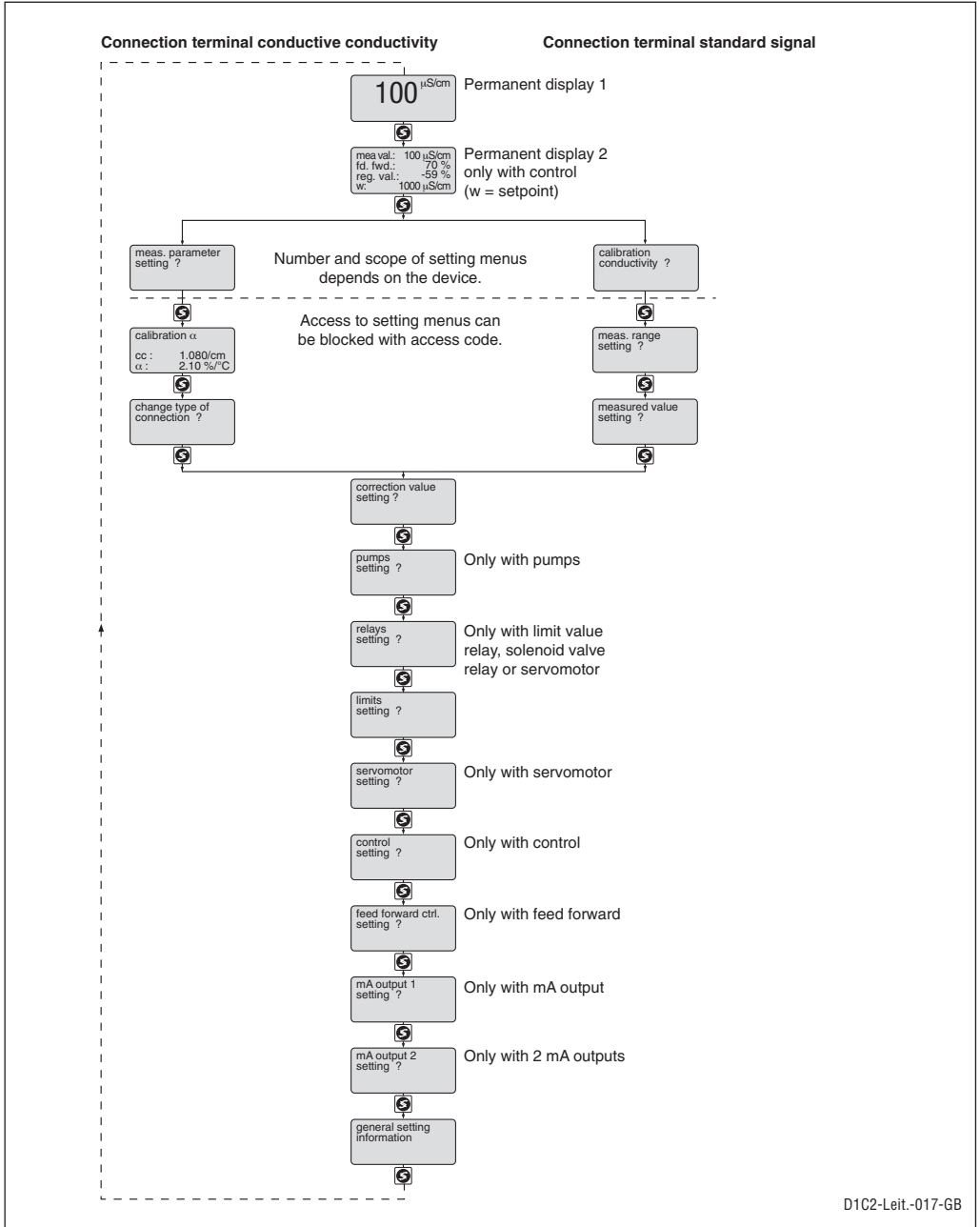

Complete Operating Menu / Description

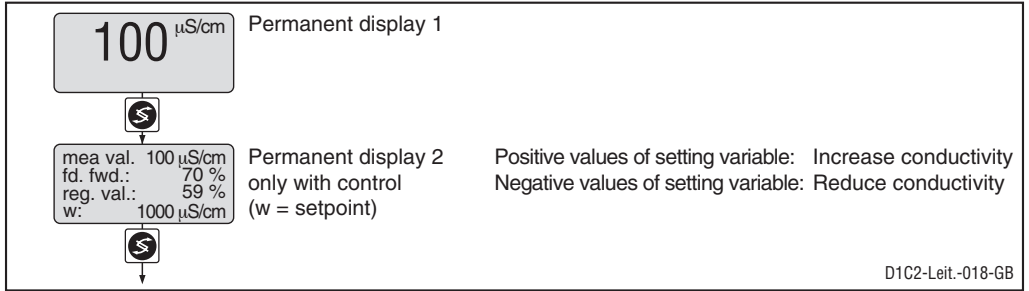

With connection on terminal standard signal see page 18

With connection on terminal conductive conductivity:

Measuring parameter (only for connected terminal conductive conductivity)

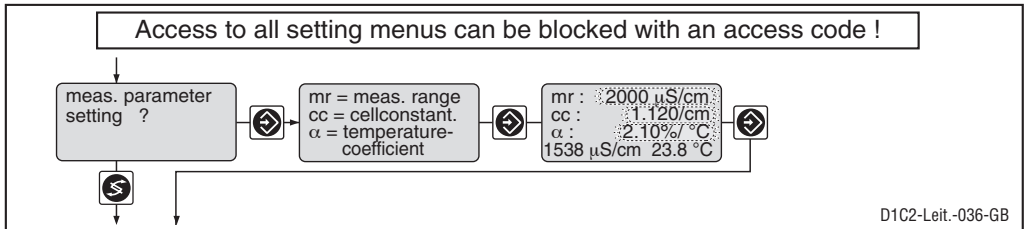

	Initial value	Possible values			Remarks
		Increment	Lower value	Upper value	
Measuring range mr	0...2000 μS/cm	0...20 μS/cm 0...200 μS/cm 0...2000 μS/cm 0...20 mS/cm 0...200 mS/cm			Setpoints and limit values are switched to the corresponding startup values
Cell constant cc	1,000/cm	0.0001/cm 0.001/cm 0.01/cm	0.0060/cm 0.150/cm 1.50/cm	0.1499/cm 1.499/cm 12.00/cm	cc can be adjusted for all mr over the complete area
Temperature coefficient α	1.90 %/°C	0.01 %/°C	0 %/°C	10 %/°C	

The measured value can be adjusted to the actual conductivity value by changing the cell constants (arrow keys). Prerequisite is a known temperature coefficient and a constant temperature.

! **IMPORTANT**
When changing the measuring range, metering and control are stopped, the setpoints, limit values, and the standard signal output are set to the corresponding startup values! Check these settings in all menus!

Complete Operating Menu / Description

Calibrating temperature coefficient α (only for connected terminal conductive conductivity)

The temperature coefficient α is newly determined by a 2-point calibration. During calibration, the D1C sets the command outputs to "0". Exception: if a basic load or a manual control output were set, these are maintained during calibration. The standard signal outputs mA (measuring value or correction value) are frozen.



ATTENTION

The conductivity values you enter must be based on 25 °C. You must use the same solution when calibrating both temperatures!

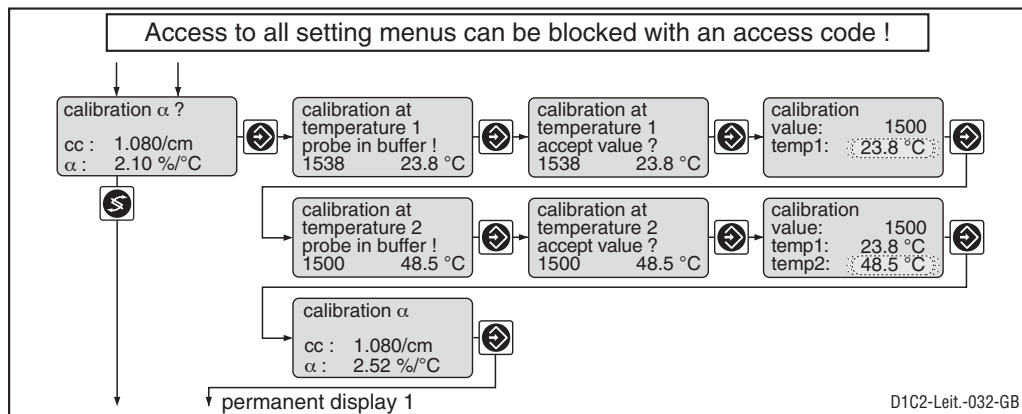

	Initial value	Possible values			Measuring range
		Increment	Lower value	Upper value	
Set sensor	Measuring value	0.01 $\mu\text{S}/\text{cm}$ 0.1 $\mu\text{S}/\text{cm}$ 1 $\mu\text{S}/\text{cm}$ 0.01 mS/cm 0.1 mS/cm	-1 $\mu\text{S}/\text{cm}$ -10 $\mu\text{S}/\text{cm}$ -100 $\mu\text{S}/\text{cm}$ -1 mS/cm -10 mS/cm	21 $\mu\text{S}/\text{cm}$ 210 $\mu\text{S}/\text{cm}$ 2100 $\mu\text{S}/\text{cm}$ 21 mS/cm 210 mS/cm	20 $\mu\text{S}/\text{cm}$ 200 $\mu\text{S}/\text{cm}$ 2000 $\mu\text{S}/\text{cm}$ 20 mS/cm 200 mS/cm
Set temperature	Correction value	0.1 °C	0 °C	100 °C	

Error message/Warning	Condition	Remarks
Temperature range restricted xx – 100 °C		For the chosen temperature coefficient α , a correct reading can only be obtained for the displayed temperature range.
Temperature distance wrong	Δ temperature ≥ 10.0 °C Δ temperature ≤ 50.0 °C	

Complete Operating Menu / Description

Sensor connection (only for connected terminal conductive conductivity)

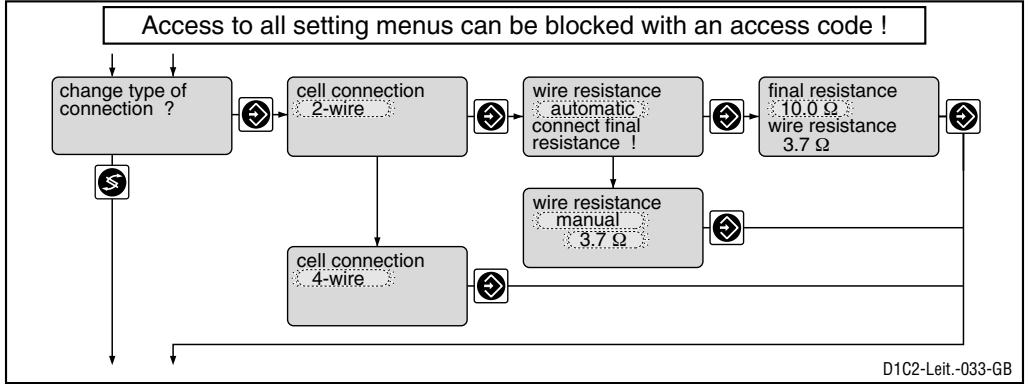

	Initial value	Possible values			Remarks
		Increment	Lower value	Upper value	
Sensor connection	2-wire 4-wire	2-wire			
Determine wire resistance	manual	manual automatic			
Manual entry wire resistance	0.5 Ω	0.1 Ω	0 Ω	50 Ω	
Final resistance	10.0 Ω	0.1 Ω	10 Ω	50 Ω	

Correction value (only for connected terminal conductive conductivity)

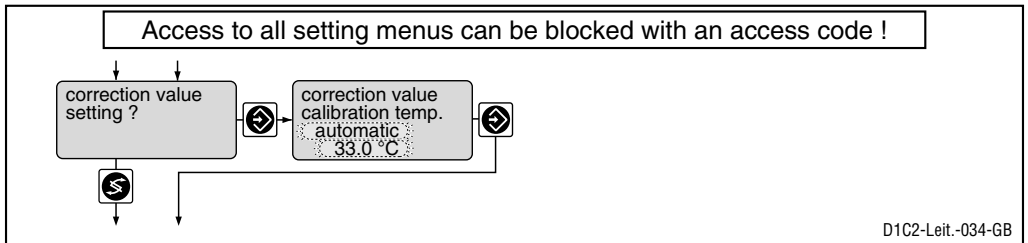

	Initial value	Possible values			Remarks
		Increment	Lower value	Upper value	
Type of temperature compensation	as per identity code	manual automatic off			
Manual temperature	25 °C	0.1 °C	0 °C	100 °C	
Automatic temperature	Correction value	0.1 °C	0 °C	100 °C	

Complete Operating Menu / Description

Calibration conductivity (only for connected terminal standard signal)

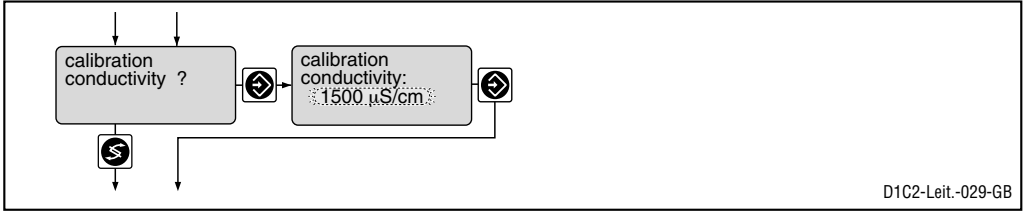

During calibration, the D1C sets the command outputs to “0”. Exception: if a basic load or a manual control output were set, these are maintained during calibration. The standard signal outputs mA (measuring value or correction value) are frozen.

The actually measured value will be proposed; this value is adjustable (arrow keys). On successful completion of calibration, all error checks which refer to the measured value are restarted.

	Initial value	Possible values			Remarks
		Increment	Lower value	Upper value	
Calibration conductivity	Measured value	depending on measuring range	depending on measuring range	depending on measuring range	

Error message	Condition effect	Remarks
Measured value too low value > xx mS/cm Check measuring range	Value < 2 % of measuring range	Check measuring range
Measured value too high value < xx mS/cm Check measuring range	Value > 100 % of measuring range	Check measuring range

Measuring range (only for connected terminal standard signal)

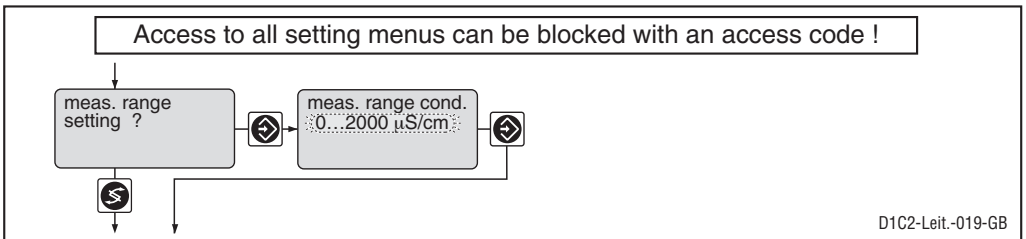

IMPORTANT

When changing the measuring range, setpoints and limit values are switched over to their respective initial values. The settings must be checked in all menus!

Complete Operating Menu / Description

	Initial value	Possible values Increment	Lower value	Upper value	Remarks
Measuring range	0....2000 $\mu\text{S/cm}$	0....1000 mS/cm^* 0....200 mS/cm 0....20 mS/cm 0....5000 $\mu\text{S/cm}^*$ 0....2000 $\mu\text{S/cm}$ 0....500 $\mu\text{S/cm}^*$ 0....200 $\mu\text{S/cm}$ 0....50 $\mu\text{S/cm}^*$ 0....20 $\mu\text{S/cm}$			Setpoints and limit values are switched over to their respective initial values *only with connection on standard signal

Measured value (only for connected terminal standard signal)

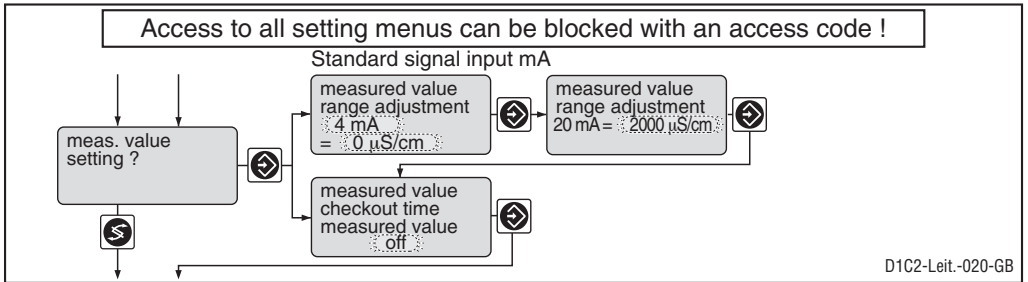

IMPORTANT
When changing the range adjustment, the adjustments in all menus have to be checked!

	Initial value	Possible values Increment	Lower value	Upper value	Remarks
Standard signal input lower signal limit	4 mA	0 mA 4 mA			
Allocated special voltage	0–2000 $\mu\text{S/cm}$	depending on measuring range	-5 % of final value	+5 % of final value	
Checkout time	off	1 s	1 s	9999 s	Constant measurement signal results in message and alarm. Function off = 0 s

Control time measuring value

IMPORTANT
This function may not be activated for applications where it can be assumed that the measuring value does not change.

This function checks whether the measuring value from the sensor (measuring value input) changes within the “control time measuring value”. It is assumed that the value does not change for an intact sensor.

If the measuring value does not change during this control time, the DULCOMETER® D1C sets the control output to “0” and the alarm relay drops out. The LCD display shows e.g. the message “check mS-probe”.

Complete Operating Menu / Description

NOTE

The following menus apply generally.

Pumps

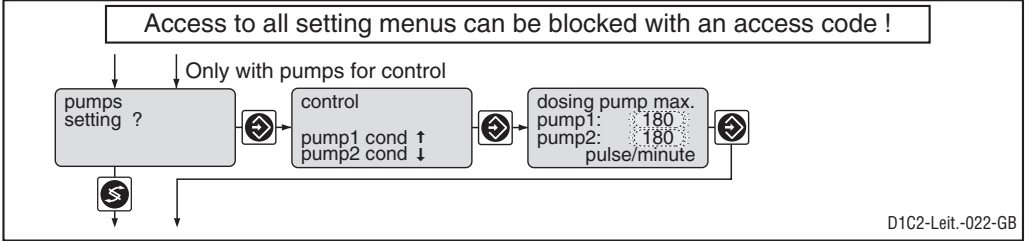

	Initial value	Possible values			Remarks
		Increment	Lower value	Upper value	
Max. stroke/minute of pumps 1 and 2	180	1	1	500	off = 0 strokes/min

Relay for power control

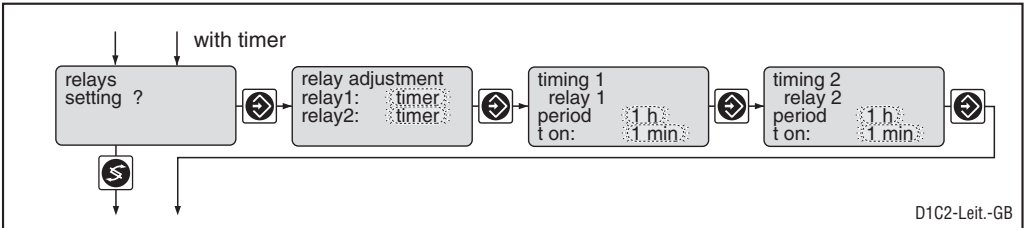
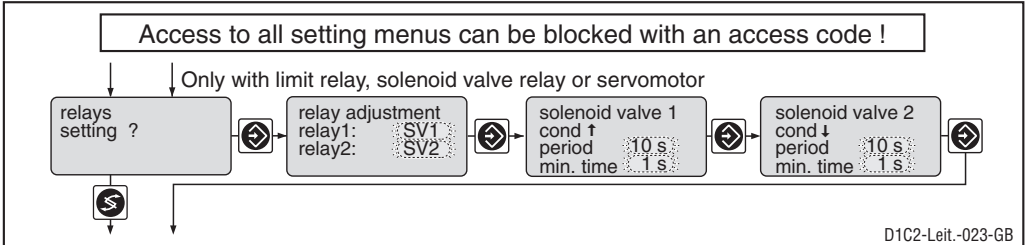

Complete Operating Menu / Description

	Initial value	Possible values			Remarks
		Increment	Lower value	Upper value	
Relay adjustment	as per identity code				
Relay 1		Solenoid valve 1 Limit value 1* Actuator 1 Timer 1 Servomotor off			*For "limit value", the relays remain active, even in the event of a fault.
Relay 2		Solenoid valve 2 Limit value 2* Actuator 2 Timer 2 off			
Cycle min. time	10 s 1 s	1 s 1 s	10 s 1 s	9999 s Cycle/2	for solenoid valve for solenoid valve Set here the smallest permitted operating factor of the connected device.
Period (Cycle) t on	off 1 min	1 h 1 min	1 h / off 1 min	240 h 60 min	for timer for timer

NOTE

The limit value relay can be defined in such a way as to respond as a control element, i.e. if a limit value relay closes a circuit, it opens when a pause contact is activated and/or for a subsequent delay period t_d (if t_d is set to > 0 min in "General settings").

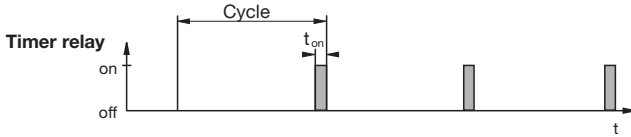

IMPORTANT

The timer will reset in the event of a power failure.

At the end of the (timer) cycle time, the DULCOMETER® D1C closes the assigned relay for the duration of "t on" (timer). "Pause" interrupts the timer.

When the clock is shown in the LC display, the timer can be reset to the start of the cycle at precisely this point using the enter button.

The % figure in the LC display indicates the progress of the current cycle.

Timer relays may be used, e.g. for shock metering or sensor cleaning.

Complete Operating Menu / Description

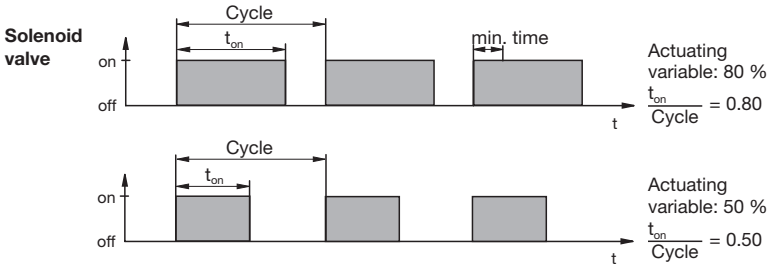

The switching time of the DULCOMETER® D1C (solenoid valve) depends on the actuating variable and the “min. time” (smallest permitted operating factor of the connected device). The actuating variable determines the ratio t_{on}/cycle and thus the switching times (see fig. above). The “min. time” influences the switching times in two situations:

a) theoretical switching time < min. time:

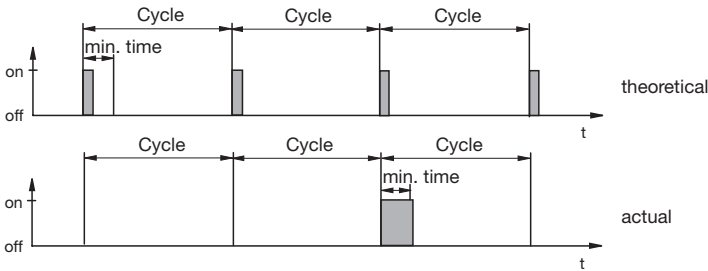

The DULCOMETER® D1C does not switch for a certain number of cycles until the sum of the theoretical switching times exceeds the “min. time”. Then the DULCOMETER® D1C switches for the duration of this total time.

b) theoretical switching time > (cycle - min. time) and calculated switching time < cycle

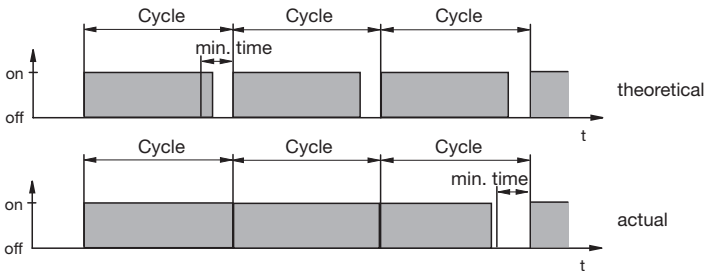

The DULCOMETER® D1C does not deactivate for a certain number of cycles until the differences between cycle and theoretical switching time exceed the “min. time”.

Complete Operating Menu / Description

Limit values

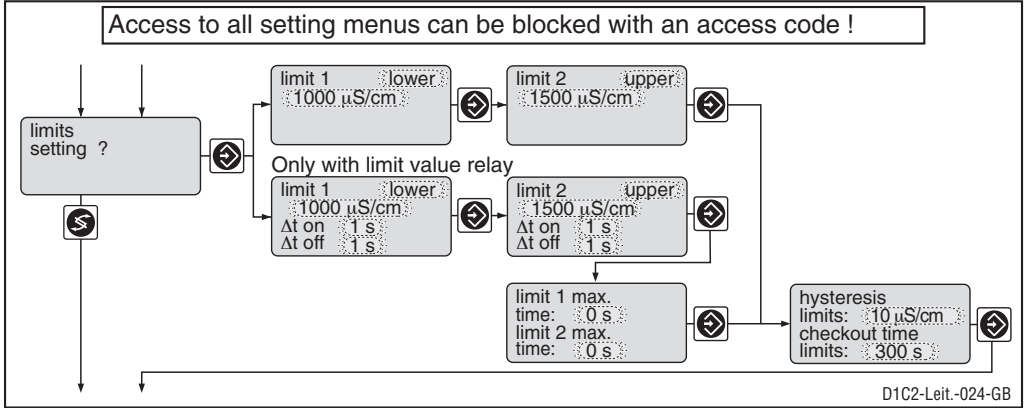

	Initial value	Possible values			Remarks
		Increment	Lower value	Upper value	
Type of limit Limit 1: transgression Limit 2:	lower upper	upper lower off*			Limit transgression when exceeding or dropping below value *only with limit value relay
Limit value 1 Limit value 2	500; 750 mS/cm 100; 150 mS/cm 10; 15 mS/cm 2500; 3750 µS/cm 1000; 1500 µS/cm 250; 375 µS/cm 100; 150 µS/cm 25; 37 µS/cm 10; 15 µS/cm	1 mS/cm 0.1 mS/cm 0.01 mS/cm 1 µS/cm 1 µS/cm 0.1 µS/cm 0.1 µS/cm 0.01 µS/cm 0.01 µS/cm	-50 mS/cm -10 mS/cm -1 mS/cm -250 µS/cm -100 µS/cm -25 µS/cm -10 µS/cm -2.5 µS/cm -1 µS/cm	1050 mS/cm 210 mS/cm 21 mS/cm 5250 µS/cm 2100 µS/cm 525 µS/cm 210 µS/cm 52.5 µS/cm 21 µS/cm	Meas. range 1000 mS/cm** Meas. range 200 mS/cm Meas. range 20 mS/cm Meas. range 5000 µS/cm** Meas. range 2000 µS/cm Meas. range 500 µS/cm** Meas. range 200 µS/cm Meas. range 50 µS/cm** Meas. range 20 µS/cm
Hysteresis limits	5 mS/cm** 1 mS/cm 0.1 mS/cm 25 µS/cm** 10 µS/cm 2.5 µS/cm** 1.0 µS/cm 0.25 µS/cm** 0.10 µS/cm	1 mS/cm 0.1 mS/cm 0.01 mS/cm 1 µS/cm 1 µS/cm 0.1 µS/cm 0.1 µS/cm 0.01 µS/cm 0.01 µS/cm	-2 mS/cm -0.4 mS/cm -0.04 mS/cm -10 µS/cm -4 µS/cm -1 µS/cm -0.4 µS/cm -0.1 µS/cm -0.04 µS/cm	1050 mS/cm 210 mS/cm 21 mS/cm 5250 µS/cm 2100 µS/cm 525 µS/cm 210 µS/cm 52.5 µS/cm 21 µS/cm	Effective in direction of "cancelling limit transgression"
Checkout time limits	off	1 s	1 s/off	9999 s	Result in message and alarm. off = 0 s: Function switched off, no message, no alarm

Complete Operating Menu / Description

	Initial value	Possible values		Remarks
		Increment	Lower value	
Controlling	on	on off		
Actuating direction limit value 1; limit value 2	active closed	active closed active open		Reacts as make contact Reacts as break contact
Switch-on delay Δt on	0 s	1 s	0 s	9999 s
Switch-off delay Δt off	0 s	1 s	0 s	9999 s

** = only for connected terminal connection on standard signal

If the limit is exceeded for longer than the "Delay time - limit values", an error message is given which must be acknowledged, and the alarm relay circuit is broken. If "Controller" is also set to "off" the control process stops.

Servomotor

The **operating range** is defined by the total resistance range of the feedback potentiometer. The maximum limit of the range actually used is set by defining the **control range**.



ATTENTION

- **Activation of the servomotor must be carried out with the same meticulous care as taken when calibrating a measuring sensor.**
- **To ensure correct operation, the activation time of the actuator used should not be less than 25 seconds for the control range from 0...100 %!**

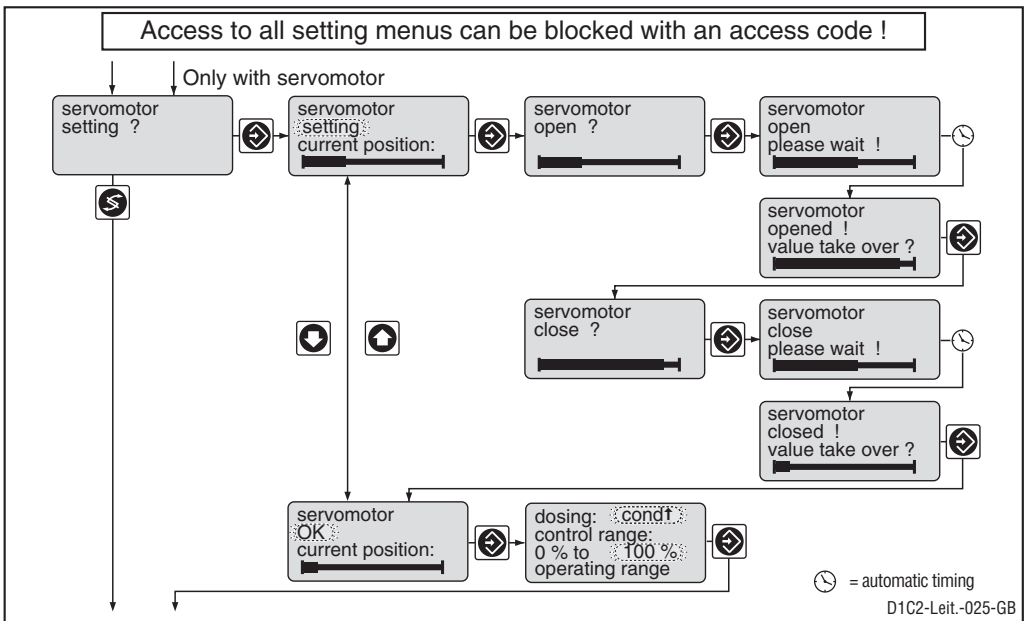

Complete Operating Menu / Description

	Initial value	Possible values			Remarks
		Increment	Lower value	Upper value	
Servomotor	Setting	Setting ok off			
Control direction	cond. ↑	cond. ↑ cond. ↓			
Control range	100 %	1 %	10 %	100 %	in % of operating range

NOTE

- If the broad bar is to the far right, the stroke adjustment motor is fully open.
- The continuous display shows the degree in % to which it is open (the greater the percentage, the more open the stroke adjustment motor).

Control

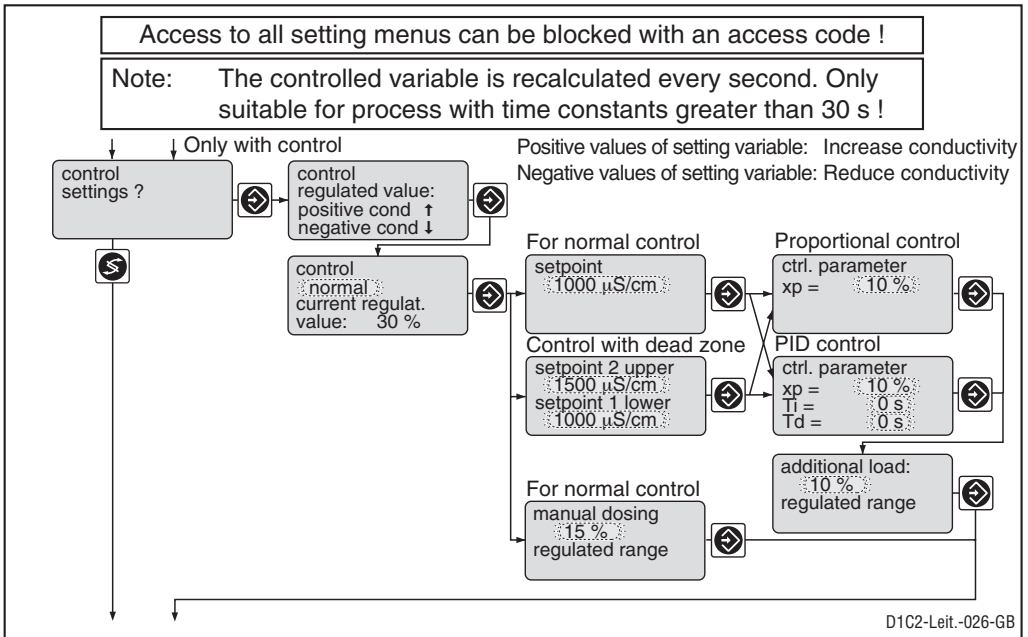

Complete Operating Menu / Description

	Initial value	Possible values			Remarks
		Increment	Lower value	Upper value	
Control	normal	normal with dead zone manual			When controlling with dead zone, the feed forward control is not used for measured values within the dead zone
Setpoint setting	500 mS/cm 100 mS/cm 10 mS/cm 2500 µS/cm 1000 µS/cm 250 µS/cm 100 µS/cm 15 µS/cm 10 µS/cm	1 mS/cm 0.1 mS/cm 0.01 mS/cm 1 µS/cm 1 µS/cm 0.1 µS/cm 0.1 µS/cm 0.01 µS/cm 0.01 µS/cm	-50 mS/cm -10 mS/cm -1 mS/cm -250 µS/cm -100 µS/cm -25 µS/cm -10 µS/cm -2.5 µS/cm -1 µS/cm	1050 mS/cm 210 mS/cm 21 mS/cm 5250 µS/cm 2100 µS/cm 525 µS/cm 210 µS/cm 52.5 µS/cm 21 µS/cm	Meas. range 1000 mS/cm* Meas. range 200 mS/cm Meas. range 20 mS/cm Meas. range 5000 µS/cm* Meas. range 2000 µS/cm Meas. range 500 µS/cm* Meas. range 200 µS/cm Meas. range 50 µS/cm* Meas. range 20 µS/cm Setpoint 2 ≥ setpoint 1
Control parameter xp	10 %	1 %	1 %	500 %	xp referred to measuring range
Control parameter Ti	off	1 s	1 s	9999 s	Function off = 0 s
Control parameter Td	off	1 s	1 s	2500 s	Function off = 0 s
Additional load	0 %	1 %	-100 %	+100 %	
Manual metering	0 %	1 %	-100 %	+100 %	

*only with connection on terminal standard signal

Abbreviations for control variables:

x_p = 100 %/Kp (inverse proportional coefficient)

T_i = I controller integration time [s]

T_d = D controller differential time [s]

Complete Operating Menu / Description

Feed forward control

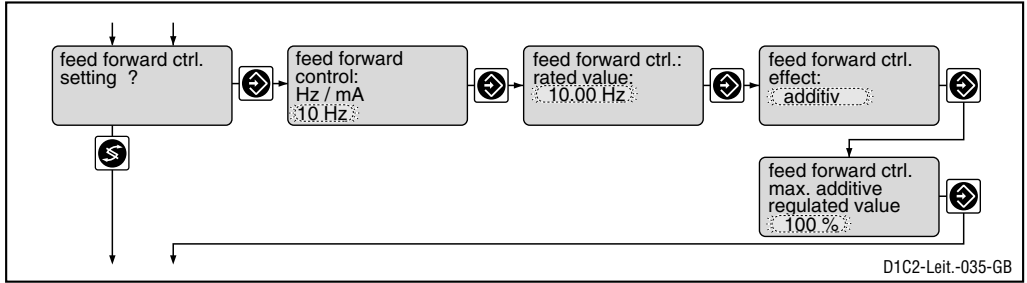

	Initial value	Possible values			Remarks
		Increment	Lower value	Upper value	
Feed forward control (Flow)	as per identity code	None 10 Hz 500 Hz			Signal processing: Signal <0.02 Hz = no flow Signal <0.2 Hz = no flow Signal <0.2 mA = no flow Signal <4.2 mA = no flow
	with standard signal: 4–20 mA	0...20 mA 4...20 mA			
Feed forward control rated value	10 Hz 500 Hz 20 mA	0.01 Hz 1 Hz 0.01 mA	0.1 Hz 5 Hz 0/4 mA	10 Hz 500 Hz 20 mA	Dependent on signal type. Maximum limitation of range used.
Feed forward control effect	multiplicative	multiplicative additive			
Max. add. regulated value	100 %	1 %	-500 %	+500 %	Only with additive feed forward control

Complete Operating Menu / Description

Standard signal output 1

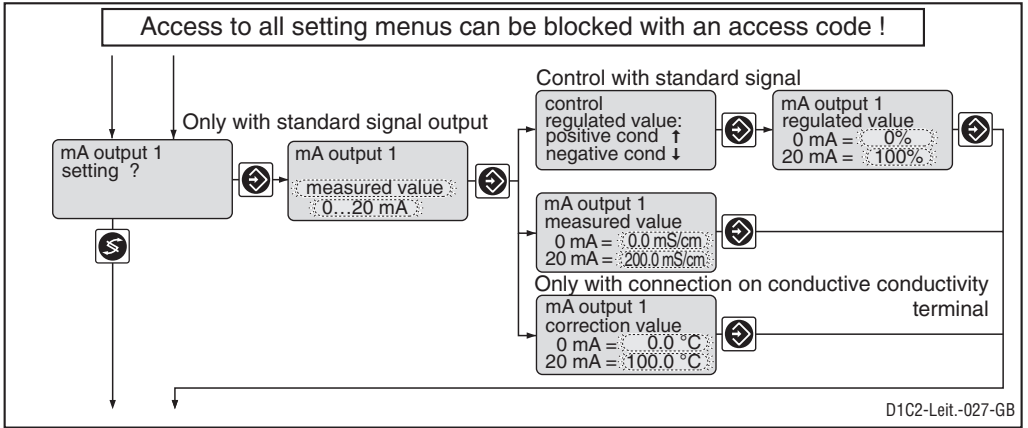

Standard signal output 2

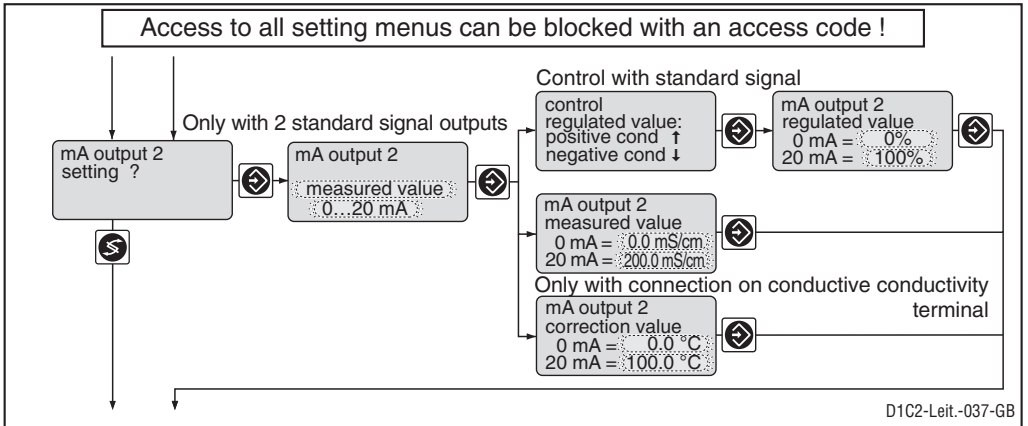

	Initial value	Possible values Increment	Lower value	Upper value	Remarks
Variable allocation	as per identity code	Measured value Controlled variable Correction value			If control applicable Only with correction variable
Output range	0...20 mA	0...20 mA 4...20 mA 3.6/4-20 mA			Reduction to 3.6 mA when alarm relay switches (not limit-value violation)

Complete Operating Menu / Description

	Initial value	Possible values			Remarks
		Increment	Lower value	Upper value	
Range measured value	0–20 µS/cm	0.01 µS/cm	-1 µS/cm	21 µS/cm	Meas. range 20 µS/cm
	0–50 µS/cm	0.01 µS/cm	-2.5 µS/cm	52.5 µS/cm	Meas. range 50 µS/cm*
	0–200 µS/cm	0.1 µS/cm	-10 µS/cm	210 µS/cm	Meas. range 200 µS/cm
	0–500 µS/cm	0.1 µS/cm	-25 µS/cm	525 µS/cm	Meas. range 500 µS/cm*
	0–2000 µS/cm	1 µS/cm	-100 µS/cm	2100 µS/cm	Meas. range 2000 µS/cm
	0–5000 µS/cm	1 µS/cm	-250 µS/cm	5250 µS/cm	Meas. ranges 5000 µS/cm*
	0–20 mS/cm	0.01 mS/cm	-1 mS/cm	21 mS/cm	Meas. range 20 mS/cm
	0–200 mS/cm	0.1 mS/cm	-10 mS/cm	210 mS/cm	Meas. range 200 mS/cm
	0–1000 mS/cm	1 mS/cm	-50 mS/cm	1050 mS/cm	Meas. range 1000 mS/cm*
Range controlled variable	0 %...+100 %	1 %	-100 %	+100 %	Minimum range 1 %
Range correction value	0....100 °C	0.1 °C	0.0 °C	100 °C	Minimum range 1 °C

*only with connection on standard signal

General setting

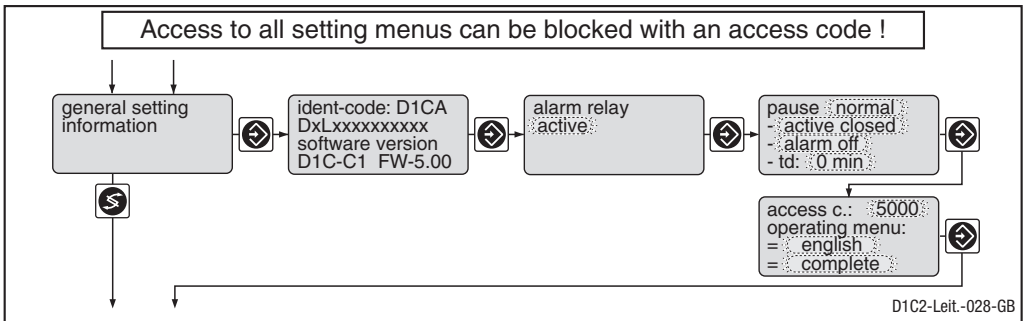

	Initial value	Possible values			Remarks
		Increment	Lower value	Upper value	
Alarm relay	active	active not active			
Pause	normal	normal hold			
Control input pause	active closed	active closed active open			Reacts as make contact Reacts as break contact
Alarm pause	off	off on			Alarm relay can be triggered by pause contact
td	0 min	1 min	0 min	60 min	
Access code	5000	1	1	9999	
Language	as per identity code	as per identity code			
Operating menu	complete	restricted complete			

Complete Operating Menu / Description

Pause Normal

If the pause switch is off, the DULCOMETER® D1C sets the operating outputs to “0” for as long as the pause switch is off or for a set time delay t_d (if t_d is set to > 0 min). Whilst the pause switch is off, the D1C establishes the P-proportion in the background.

With PID-control (identity code characteristics “control characteristic” = 2): the I-proportion is stored when the pause is switched off (I-proportion then usually only present if $T_n > 0$ has been selected in the “Control setting?” setting menu).

Exception: the standard signal outputs mA for the measured value or correction value are not affected by the pause.

After pause is activated, the operating outputs remain at “0” for the length of the time delay t_d . The time delay t_d must be set up in such a way that in this time e.g. sample water (process-specific current concentration) flows to the sensor.

With PID-control (identity code characteristics “control characteristic” = 2): The control variable output resulting from the pause and the expiry of the time delay t_d is reconciled jointly with the current P-component and (if T_n is set > 0) with the stored I-component.

Pause hold

If the pause switch is off, the DULCOMETER® D1C freezes the operating output at the most recent value for as long as the pause switch is off or for a set time delay t_d (if t_d is set to > 0 min). Whilst the pause switch is off, the D1C establishes the P-proportion in the background.

With PID-control (identity code characteristics “control characteristic” = 2):

Even the mA standard signal outputs for measured value or correction value are frozen.

After pause is activated, the operating outputs remain frozen for the length of the time delay t_d . The time delay t_d must be set up in such a way that in this time e.g. sample water (process-specific current concentration) flows to the sensor.

With PID-control (identity code characteristics “control characteristic” = 2): The control variable output resulting from the pause and the expiry of the time delay t_d is reconciled jointly with the current P-proportion and (if T_n is set > 0) with the newly established I-proportion.

Access Code

Access to the setting menu can be prevented by setting up an access code. The DULCOMETER® D1C controller is supplied with the access code 5000 which permits free access to the setting menu. The calibration menu remains freely accessible even when access to the setting menu is blocked by the code.

9 Fault / Remarks / Troubleshooting

Fault	Fault text	Symbol	Effect	Alarm with acknowledgement	Remarks	Remedy
Measured value Signal exceeds/drops below value*	<i>mS-meas. range</i> ↑↓	€	Basic load	Yes	Measured value out of measuring range. Signal <3.0 ±0.2 mA or >23 ±0.2 mA	Check range adjustment Check sensor, transducer and cable connection
	<i>Check mS-input</i>					
Checkout time meas. value exceeded*	<i>Check mS-probe</i>	€	Basic load	Yes	Function detachable	Check function of sensor, Extend checkout time
	Correction measured variable Signal exceeds/drops below value*	€	Basic load	Yes	Signal <3.0 ±0.2 mA or >23 ±0.2 mA $\alpha \geq 4\%/^{\circ}\text{C}$	Check sensor, transducer and cable connection
upper limit temperature exceeded	<i>Check te-input</i> <i>te-limit</i> ↓					
Feed forward control Signal exceeds/drops below value*	<i>Check feed forward input</i>	€	Basic load	Yes	Signal <3.0 ±0.2 mA or >23 ±0.2 mA Value last valid is used	Check sensor, transducer and cable connection
Limit value violation Control "on" Control "off"	<i>mS-limit 1</i> ↑↓ <i>mS-limit 2</i> ↑↓	€	Stop or basic load	Yes	Function detachable	Define cause, reset values if necessary
Servomotor Position not reached	<i>Servomotor defective</i>	€	Stop	Yes	Servomotor closes	Check servomotor
Electronics error	<i>System error</i>	€	Stop	Yes	Electronic data defective	Call in service

Operation	Note text	Symbol	Effect	Alarm with acknowledgement	Remarks	Remedy
Pause contact	<i>Pause</i>	€	Stop	No/Yes**	No further fault check	-
	<i>Pause/hold</i>	€	Stop			
Stop button	<i>Stop</i>	€	Stop	No	Relay drops out	-
Calibration* Calibration with error	<i>Check meas. range</i>	€	Basic load	-	-	Repeat calibration Check sensor/buffer
During servomotor setting Position feedback wrong	<i>Direction check</i>		Stop		Without correct adjustment the last valid values are still used	Check connection of relay, potentiometer
Upper position <40 % max. value Lower position >30 % range	<i>Final value too small</i>					Adjust the operation region of the servomotor correctly
	<i>Final value too big</i>					

* only with connection on standard signal
 ** Depends on whether "alarm off" or "alarm on" in "General Settings".

